

TEACHER'S BOOK

OLD-TESTAMENT 1



MEDITATION (BIBLE VERSES FOR TEACHERS)

When Jesus saw it, he was angry and said to them, "Let little children come to me, and do not forbid them; for such is the kingdom of God" (Mark 10:14).

Truly I tell you, whoever does not receive the kingdom of God as a little child will never enter it (Mark 10:15).

Teach a child in the way he should go, and when he is old he will not depart from it (Proverbs 22:6).

He said to them, "Whoever welcomes such a little child in my name welcomes me; and whoever welcomes me welcomes the one who sent me. He who is the least of all of you is the greatest." (Luke 9:48)

SUNDAY SCHOOL WORSHIP ORDER

1. Worship and praise
2. (Apostles' Creed) Representative Prayer
3. Bible reading (with action)
4. Sermon (Bible Fairy Tale)
5. Offering prayer
6. Lord's Prayer
7. Advertisements
(Welcome to new friends, etc.)
8. Activities after worship
(feedback/ coloring book/ game activity)



SONGS

INDEX

1. I WAS SO SURPRISE
2. MY GOD IS SO GREAT
3. MASTERPIECE
4. JOY DOWN IN MY HEART
5. OH LORD, HERE I COME TO YOU
6. I'LL FOLLOW THE LORD

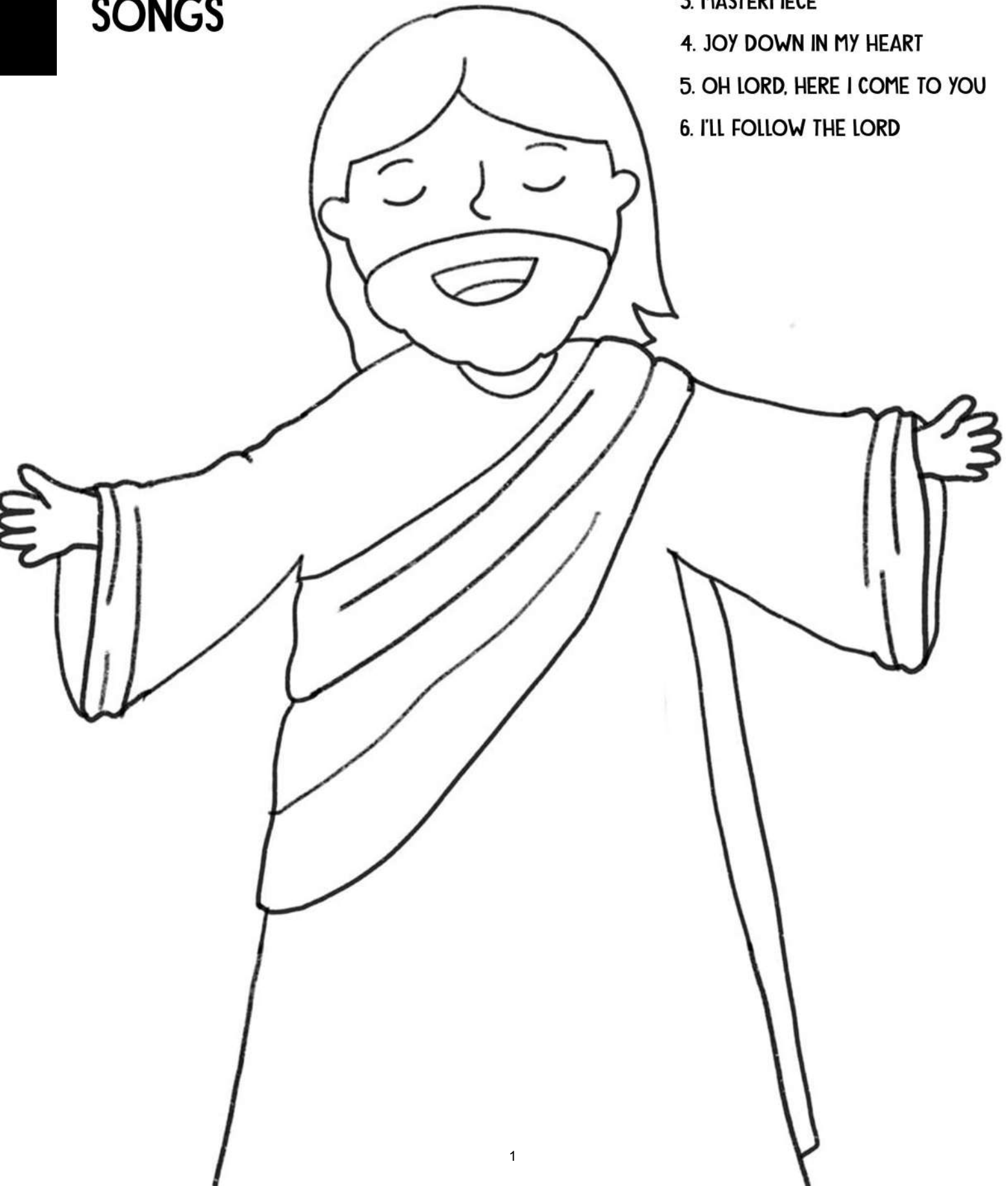

1. I WAS SO SURPRISE

I was so surprised, that Jesus, my lord loves me
 I was so surprised, that Jesus, my Lord saved me
 I was so surprised, that he died on the cross just for me
 I was so surprised, that Jesus called us, his children. I didn't know
 before, all about this good news The reason why Jesus had come to the world
 Now I know, I hear it and believe it, Jesus Christ is my savior.
 yeah yeah yeah yeah I was so surprised, That Jesus, my Lord loves me
 I was so surprised, that Jesus, my Lord saved me

2. MY GOD IS SO GREAT

My God is so great So strong and so mighty, There's nothing my God cannot
 do, for you! The mountains are his, the rivers are his the
 starts are his handiwork, too My God is so great, so strong and so mighty
 There's nothing my God cannot do, for you for you for you and me!

3. MASTERPIECE

Musical notation for the song 'Masterpiece'. It consists of four staves of music in a 4/4 time signature with a key signature of one flat (B-flat). The lyrics are: 'The Lord God formed the man From the dust of the ground. And he gave the life to the man by breathing into him You're the master-piece of God, the be—st work of him I'm the master-piece of God, the be—st work of him'. Chords are indicated above the notes: F, Bb, Gm, C7, C, F/D, C/E, F, Fsus4, F, Bb, Gm, C7, C, C/E, F, F, Bb, C7, /E, F, F, Bb, C7, /E, F.

4. JOY DOWN IN MY HEART

Musical notation for the song 'Joy Down in My Heart'. It consists of three staves of music in a 4/4 time signature with a key signature of one sharp (F-sharp). The lyrics are: 'I have the joy joy joy joy down in my heart Down in my heart down in my heart. I have the Down in my heart to stay I am so ha-ppy, very ha-ppy I've got the love of Jēsus in my heart I am so got the love of Jēsus in my heart'. Chords are indicated above the notes: G, C, G, F, G, C, |1. G, C, G, |2. G, C, C7, F, C, |1. G, C, C7, |2. G, C.

5. OH LORD, HERE I COME TO YOU

Oh Lord, Here I come to you. With an excited heart i've waited you. Oh Lord, here I come to you. I give all my loving heart to you. I worship you my lord, who is here now in this moment. I worship you only God who is here with us in this place.

Chords: Bb, F/A, D7, Gm7, C7, F, Dm, Bb, C, F, D7, Gm, C7, F, F7, Bb, F/A, Dm7, Gm7, C7, F, F7, Bb, F/A, D7/F#, Gm, C7, F.







6. I'LL ONLY FOLLOW THE LORD

I'll only think of the Lord, I'll not have any other thoughts.
 I'll only follow the Lord, I'll not go to other place.
 1) If I only follow the Lord, I'll receive true joy.
 2) If I only follow the Lord, He will forgive all my sin.
 If I only follow the Lord, I'll receive crown of Life
 If I only follow the Lord, He'll call my name from heaven.







Chords: G, D, G, D, G, G7, C, G, D, G7, C, G, D, G.

ACTING WORD

1. Then God blessed the seventh day and sanctified it, because in it He rested from all His work which God had created and made. Genesis 2:3

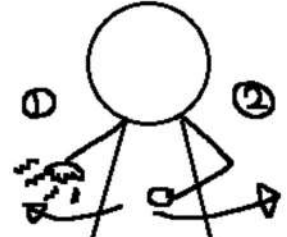



Then God Blessed		Both hands raise up
The seventh day		Show number 7
And sanctified it		Both hand roll down from up to down
because in it / He rested		Clap X 2
from all His work which God		Twisting both hands and draw big circle
Had created / and made		Both fist tap twice on right and left (like hammering position)

2. Then the LORD God formed a man from the dust of the ground and breathed into his nostrils the breath of life, and the man became a living being. Genesis 2:7

Then the Lord God		Both hands raise up
Formed a man		Both hands squeeze twice on eye-level and shoulder-level (*squeeze-make a fist and release)
From the dust/ of the ground		Each hand like piano playing move center to right/left side
And breathed into his nostrils		Both hands on nose and spread to each side
The breath of life		Both hands back to the nose
And a man became		Tap head and shoulder
A living being		Walking position

ACTING WORD

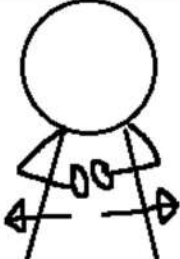

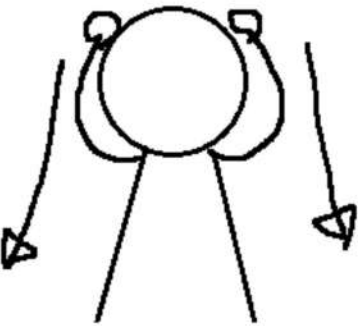



3. The LORD God made garments of skin for Adam and his wife, and clothed them. Genesis 3:21

Then Lord God		Both hands raise up
Made garments		Like sewing position
Of skin		Both fist stretch from center to each side
For Adam /and his wife		Each hand raise up
And clothed them		Both hands sweep down from head to down

ACTING WORD



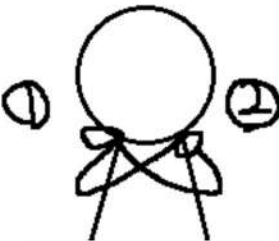

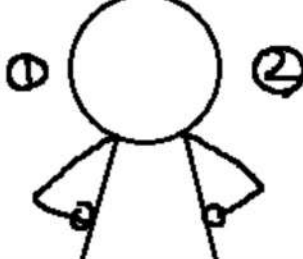
4. But if you do not do what is right, sin is crouching at your door; it desires to have you, but you must master it.

Genesis 4:7

But		Clap
If you do not do what is right		Left hand under right elbow and draw big X with right hand
Sin is crouching at		Open each palm to front (like blocking with hands)
Your door		Move your head to one side to see front
it desires to /have you		Hug yourself, one hand at one time
but		clap
You must/ master it		Each hand to the waist

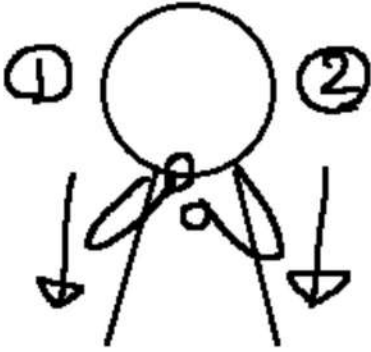



ACTING WORD

5. Noah did everything just as God commanded him Genesis 6:22

<p>Noah did</p>		<p>Each hand brushing down from chin to chest</p>
<p>Everything just as</p>		<p>Draw big circle using both opened hand from waist line to each side</p>
<p>God</p>		<p>Both hands raise up</p>
<p>Command him</p>		<p>Both hands to the mouth</p>

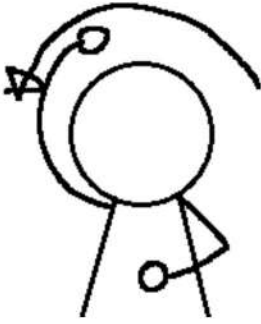



ACTING WORD

6. I have set my rainbow in the clouds, and it will be the sign of the covenant between me and the earth. Genesis 9:13

<p>I have set my rainbow</p>		<p>One hand draw big half circle over your head(like a rainbow)</p>
<p>In the clouds</p>		<p>Use other hand to swipe the sky from center to the other side</p>
<p>And it will be</p>		<p>Clap</p>
<p>The Sign of covenant</p>		<p>Make promising position and up-down for twice</p>
<p>Between me and the earth</p>		<p>Each hand opens to each side</p>





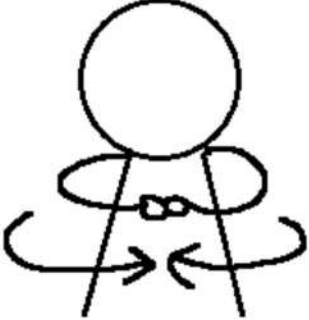



ACTING WORD

7. Therefore its name was called Babel, because there the LORD confused the language of the whole earth Genesis 11:9

Therefore its /name was called		Left hand building position from down to up/ right hand stays higher level than a left hand
Babel		Both hands make a mountain shape(triangle)
Because there / the LORD		Each hand raise up
Confuse the language		Twinkling hands and turn your body around
Of the /whole earth		Each hand to the center making a big circle





ACTING WORD

8. I will make you into a great nation and I will bless you; I will make your name great, and you will be a blessing
 Genesis 12:2



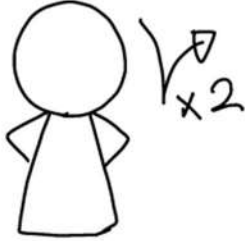

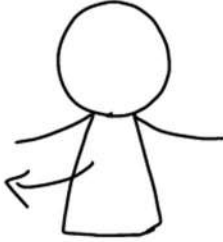
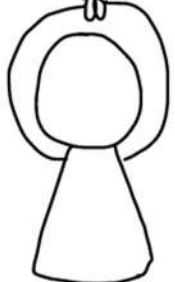

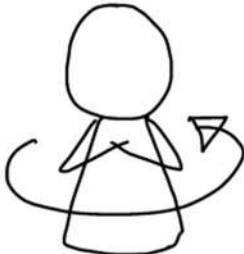
I will		Right thumb up and point the chest
Make you		Right palm open to the front
Into a great nation		Both thumbs up and raise up
And I will		Right thumb up and point the chest
Bless you		All fingers shake(like playing piano) and sweep down from top (like expressing raining day)
I will make		Right thumb and point the chest
Your name great		Left thumb up and swing down to up
And you will be the blessing		All fingers shake while both hands swing from center to each side

ACTING WORD



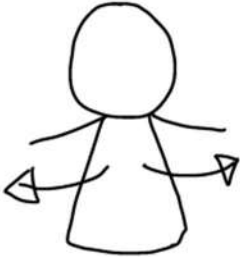

9. Abraham will surely become a great and powerful nation, and all nations on earth will be blessed through him. (Genesis 18:18)

Abraham /will surely		Both hands on waist and nod twice
Become a great		Right hand makes round to right
And powerful nation		Left hand makes round to left
And all nations on earth		Both hand make big circle up and meet overhead
Will be blessed		Cross the hand and down to the chest
Through him		Make a turn

10. But Lot's wife looked back, and she became a pillar of salt. (Genesis 19:26)



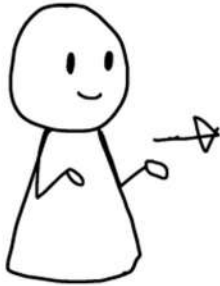

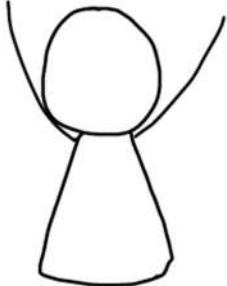

But		Clap
Lot's wife		Greeting gesture with holding skirt
Looked back		Both hands on waist and look back side
And she		Clap
Became a		Both hands to the side
Pillar of salt		Make a pose and stop

11. Now I know that you fear God (Genesis 22:12)



Now		Right hand on the chest
I know		Left index finger to left side of head
That you		Both hands straight and down half way
Fear		Right hand raise to right side
God		Left hand raise to left side

ACTING WORD





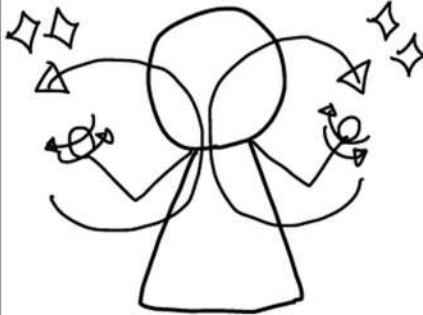
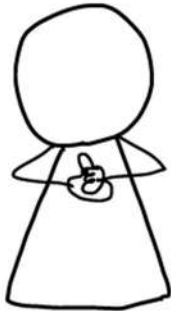

12. I praised the LORD, the God of my master Abraham, who had led me on the right road (Genesis 24:48)

I praised		Both hands to mouth
The LORD / the God of		Right thumb down to chest and left palm goes down to right hand / Raise it high
My master, Abraham		Right fist down and left hand to waist. (like holding a walking stick posture)
Who had		Right hand make a round to right side
Led me		Left hand make a round to left side
On the right road		Both hand straight forward



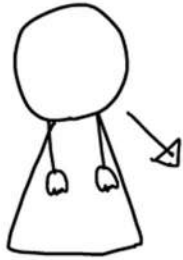

13. We saw clearly that the LORD was with you (Genesis 26:28)

We saw		Both hands to eyebrow level
Clearly		Twinkle twinkle hands drawing each circle
That the LORD		Right thumb at the chest level and left palm underneath
Was with you		Make a turn

14. So he swore an oath to him, selling his birthright to Jacob. (Genesis 25:33)







So he		Both hand together at the chest
Swore an oath		Push it forward
To him		Open hands
Selling his		Giving out or sharing posture
Birthright		Twinkle twinkle posture
To Jacob		Clap

15. May he give you and your descendants the blessing given to Abraham (Genesis 28:4)

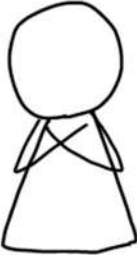



<p>May he give you</p>		<p>Right hand roll down from shoulder to straight down</p>
<p>And your descendants</p>		<p>Left hand roll down from shoulder to straight down</p>
<p>The blessing given to</p>		<p>Twinkle twinkle hands drawing each circle in front</p>
<p>Abraham</p>		<p>Clap</p>

ACTING WORD

16. I will not leave you until I have done what I have promised you (Genesis 28:15)

I will not		X gesture
Leave you		Slash the hands down
Until I have		Right hand draw circle to right side
Done what I		Left hand draw circle to left side
Have promised		Promising hand posture
you		Open hands to front

17. So do whatever God has told you (Genesis 31:16)

So do		Jump and opened palm on each side
Whatever		Both hands draw big circle in front
God has		Right thumb at the chest level and left palm underneath
Told you		Both hand to mouth(speaking gesture)

SERMON COMMENTARY

1. Who made this world? (Genesis 1:1-2:3)

My beloved friends! Who had created this world? Yes, God created this world. As none of human being can explain exactly how it happened or looked like, his creation is just unbelievable and amazing.

First, everything had formed just by his spoken word. When God said, "Let there be ...", then everything just happened as what he said. He said, "Let there be light.", "Let there be separation between water from water.", and "Let dry ground appear." Just saying out those words, he created this whole world. That`s why we have to know and accept the God as our creator and listen to his words.

Second, we could see his detailed plan from his creation of this world.

He created the sun and the moon after the vegetation for them to grow well. He also settles everything perfectly in order before he creates human being. Don`t forget that we are been created by his image from his wonderful plan, so always trust God and follow his words.

Third, God separates the light from the darkness, and he said it was good.

This separation connects to message shared by Paul in New testaments, the separation between believer from unbeliever, and righteous one from violent one.

"Do not be yoked together with unbelievers. For what do righteousness and wickedness have in common? Or what fellowship can light have with darkness? What harmony is there between Christ and Belial? Or what does a believer have in common with an unbeliever?" (2Corinthians 6:14-15)

We have to be the righteous one as the children of God by remembering his saying 'It was good' after his creation of the light. Then, we will be entering the kingdom of God which is been prepared by him for us.

Everybody, let`s all be a good one to make our God happy on this wonderful creation of him.

2. Adam and Eve (Genesis 2:4~2:25)

My beloved friends, we`ve learned how human being was created by this story.

First, God formed a man from the dust and blow the breath to the nose, then the very first man start breathing. This message is also telling us that if God took our lives, then we`ll be all going back to the dust, which means all the lives are on the hand of God. That`s why we have to obey his words and live as how he guide us.

Second, God prepared the Garden of Eden for Adam and Eve to live well, like he created trees with full of sweet fruits and fresh stream of water for all living creatures to grow well. Then, God let Adam to rule over the Garden of Eden. As the First man was joyful and grateful to work as what God told him to do, we also have to be grateful and joyful to work with God.

Third, God did not leave Adam alone. God created a woman to be with Adam. God created Eve to be with Adam helping him to have happy life. That`s why when we grow up, man and woman will marry to help each other to make a beautiful family.

My beloved friends, next time we`ll listen about when Adam and Eve disobey the word of God. Let`s pray for not to forget what we`ve learned today.

3. No Excuses. (Genesis 3:1~3:24)

My beloved friends, how did you feel hearing today`s story?

Did you hate the snake tempting Eve? Maybe, you hate Eve who fell on snake`s temptation? Or you hate Adam who fell on Eve`s lure? Did anyone thought that, if they didn`t fell on the temptation of snake, then we won`t be struggling with sin now a day? These resentments and hatreds are the sin that God is not happy with.

Adam and Eve disobey the word of God that allowed them to eat every fruits from the garden except from that one tree of knowledge of good and evil. They took that fruits and sinned against God. They felt ashamed knowing that they were naked after they sinned against God, so they tried to hide. Isn`t it same as we trying to hide from our parents or teachers when we do something wrong or lied about something? When God look Adam, he start blaming Eve that she was the one who made him to disobey God, Adam did not admit his fault. How about Eve? She also blamed snake first and telling excuses about why she took that fruit.

How about us? Don`t we do same as them? "It was my sister who made this thing to happen, it was my brother told me to do, or it was my friend..."

God will forgive us when we admit our sin and repent to him, but we tend to think excuses first. "You must not eat from the tree of the knowledge of good and evil, for when you eat from it you will certainly die." But God did not kill Adam and Eve on that place. God clothed them with the leather which will not dry or goes bad easily instead of leaves that they were wearing. He forgives them and show them his love. My friends, I believes that we will win from those temptations to repent our sin and stay in the love of God.

4. Cain and Abel (Genesis 4:1~4:15)

My beloved friends! Isn't it painful to hear about the very first murder case of the human being?

We were able to see how disobedient of Adam and Eve changed their lives. They were kicked out from the Garden of Eden and work hard to make food for them. Also, their sin of disobedient was being done by their child and to people now a day. More terrible sins are being done by so many people. But our loving God is forgiving us with his generosity. As God did not kill Adam and Eve when they sinned against to God, he still is being generous to Cain who killed his brother. He gave marks on Cain not to be killed from the people but to be protected.

We can never understand how great his love is. We have to tell God about what we've done wrong against him. Our God is always waiting for us to get back to him and repent our sin.

"Where are you Adam? Where are you Cain?" "Why did you do that? Why are you angry?"

God was always calling us to get back to him.

My friends, when we talk to God, it is been called praying.

We have to open our heart, be honest to God to repent about what we've done wrong against him, and don't miss his great love, the salvation.

Also, let's worship God with all our heart for him to receive with joy as how God accepted the Abel's sincere offering.

5. Noah (Genesis 5:25~6:22)

My beloved friends, we've heard about righteous man, Noah. Let's all read Genesis 6:22 again.

"Noah did everything just as God commanded him." Noah followed the word of God and built an ark on the mountain which took 120years. God could not bear those sinful lives on earth anymore, so God decided to wipe with water. He commanded to Noah.

God was actually waiting for people to repent and get back to him during Ark was built by Noah. But sinful people were talking about Noah that he is crazy by seeing him building an ark for that long time. "What on earth building ark on the top of mountain, he must be crazy. How poor his children are!" Do you think Noah didn't heard about people saying against him? He knew it, but he was just obeying the word of God not caring what people said about him.

Noah obeyed and followed what God commanded to him with his faithful heart.

My friends, I hope all of us could be praised by God by our faithful heart to obey him, just as Noah did. We'll next hear what happen to those sinful people who ignored God and laughed at Noah.

6. The Flood and The Rainbow (Genesis 7:1-9:17)

My beloved friends, Noah finally completed building an ark. That ark was built just to float on the water not for the sailing purpose, so it didn't had that cool boat shape. Noah's family and pair of all living creature enter that strongly solid ark. Total of one year and 10days were taken for this punishment with flood. Noah even have to wait 57 more days in the ark after the water finally receded from the land, because he was waiting the words from God. Noah finally stepped out from the ark when God told him to do so. You know what was the very first thing that Noah did? He built an altar to worship God.

My friends, let us all be faithful and sincere as how Noah and his family waited for God's command before anything else. Then, I'm sure that God will also give us the blessing covenant just as how God gave covenant to Noah with rainbow. God sent Jesus to earth and promised us that if we truly believed in him, we could have the eternal life with God. Let's all remember his generous promise to us and live as the children of God.

7. The tower of Babel (Genesis 10:1-11:9)

My beloved friends, try to tell some words to friends next to you by not saying a words from your mouth. Can you anyone understand what they are saying? What if a foreigner tries to talk to you in other language that you don't understand? Will you not feel frustrated? Today we had heard about how human being spread to all over the world with different language because of their arrogance. People didn't stay humble as they could but they even thought that they could build an huge towel to prepare for flood, like what happen to Noah's time.

God knew that people with one language will stick to this plan to stand against God, so he decided to give different language to people for them to spread to different place from each other.

My friends, let`s all imagine that how will it be to live with your family if you can`t understand what they are saying? Will you be able to live well with them?

We always have to trust God and walk with him as a children of God. Let`s all see our heart if we have any of that arrogant Babel towel in us thinking that I could do it by myself? Then, we have to repent to God and get back to him to humbly listen to words of God.

8. Abram, The Root of Every Blessing (Genesis 9:18-27, 12:1-20)

My beloved friends, today we`ve heard about Abraham, the father of faith. Let`s think how he obey the word of God which said to leave his country, people and even his father`s household. Will you be able to obey God`s command and leave everything behind and go? Where will you sleep? What will you eat? Will it not be scary to live alone? Probably, fear will overwrap you and you would feel so scared to step out. But see how Abram obey the word of God. Abram gave up those three things but being blessed by God with three things. God promised him the new land for Abram to leave his country, being a father of nation for Abram to leave his families, and promise of blessing for Abram to leave his father`s household.

“I will make you into a great nation, and I will bless you; I will make your name great, and you will be a blessing. I will bless those who bless you, and whoever curses you I will curse; and all peoples on earth will be blessed through you.” Genesis 12:2-3

My friends, let`s all be in God`s blessing by obeying his words and act right away, as how Abram did.

Let`s all share this wonderful message to all our families and friends to be live in his blessing.

9. Abraham, the new name of Abram (Genesis 17:1~17:27)

God loved His people so much. That's why He changed Abram's name to remind him of God's promise. He turned Abram into Abraham and blessed him with circumcision as a sign of God's covenant. We now live within the fruit of that blessing. God sent us Jesus so that, through His sacrifice on the cross, our sins could be forgiven, and we could become God's children. Through Jesus' resurrection, we also have new life and the privilege of living as God's children.

In the Old Testament, circumcision was a way to remember God's promise, but now, if we believe in Jesus, repent, and live according to His teachings, we receive the blessings of God's promises. Baptism helps us better in understanding God's promises. Let's remember Jesus' love on the cross and express our love for God before Him through baptism.

Let`s say all together, "Dear God, we love You! Thank You for choosing us to be Your children."

Now, as being his children, let's seek to know about God's heart every day through His Word and meet him by praise and worship him. God dwells in our worship. Even now, God is pleased to see all of you in this place. Our loving God, who sends Jesus to save us, we sincerely love and thank you.

10. The falling of Sodom and Gomorrah (Genesis 18:16~19:29)

In the land of Sodom and Gomorrah, the people did many bad things and didn't worship God. They lived sinful lives, which made God very upset. He decided to destroy those cities. However, Abraham begged to God to save his nephew Lot and his family. God saved Lot's family, and angels were sent to guide them to a safe place.

Just like Abraham cared for his family, we should pray for our families too. If we have family member who haven't been to church yet, we should keep praying for them. If they don't believe in Jesus, sadly they will end up in hell. We believe in Jesus and will go to heaven, but if our family or friends don't believe in Jesus at end, they will go to hell. We don't want that for our loved ones.

Even though we can't see God, we can still talk to Him through prayer. It's wonderful that we can do that. Let's live as children of God, avoiding the sins which He dislikes, and following His Word. Until we enter heaven with our family and friends, let's worship and share about the grace of Jesus' cross.

Also don` t forget how Lot's wife turned into a pillar of salt because she looked back. Let's be careful to just follow God's rules and be praised for being faithful children of God. Let's try to receive God's love every day.

11. Sacrifice your son Isaac as an offering (Genesis 17:15~19, 18:9~15, 21:1~22:19)

Our friends, can you imagine how happy Abraham must have been when he had a son at the age of 100? But when God asked him to offer his son as a sacrifice, how sad he must have felt! However, Abraham's thoughts were different from ours. He understood God's heart. He knew that God is full of grace and love. So, he went up the mountain and built an altar to offer his son Isaac to God. He even raised the knife, ready to obey God's command.

If it were us, we might have cried and asked God to save Isaac's life. But Abraham had unwavering faith and trust in God, no matter what. So, he told his servants that they would come back together. God saw this absolute faith and obedience in Abraham, and He called out, "Abraham!" praising his faith. Of course, God saved Isaac's life and provided a ram as a substitute sacrifice. God knew that Abraham would obey so completely, so He prepared the ram.

Don't you envy Abraham, our friends? We should learn from him, who was recognized as a man of unwavering faith. Remember that God loves us so much that He sent Jesus for us, so we should believe in Jesus, worship Him faithfully, obey His words, and follow His teachings. And when we do this, God will call us by our name and praise us. Even Jesus loves and praises us greatly. Let's love worship time while thinking about the love of Jesus, and confess our love to God, Jesus and Holy Spirit every day. Our loving God will be so pleased with us.

12. Marriage of Isaac and Rebekah (Genesis 24:1~24:67)

Our friends, Abraham believed in God and prayed to find a wife with faith for his son Isaac. He sent his servant far away to meet the wife that God had prepared. The servant didn't have faith, but because Abraham prayed, he got trusted heart that God would lead him to the right woman. And indeed, the servant found a kind, gentle, and merciful woman named Rebekah. He saw her giving water to passersby and even to the camels. Her kind and warm-hearted nature impressed him.

The servant met Rebekah at the well, and she turned out to be the lady Abraham had prayed for – good-natured and kind. He talked to her family about marrying her to Isaac, and Rebekah obediently followed God's command and journeyed far to where Isaac lived.

Our friends, let's also pray before God and seek to understand His will, obeying His words. Let's pray for a good heart like Rebekah's, loving our neighbors and showing mercy to others. Just like God chose Rebekah as Isaac's wife because of her kind nature, let's pray to live as friends who are called and chosen by Jesus, loving our neighbors and showing love to them

Just as God called and chose us, let's pray to become children of faith, fulfilling the purpose Jesus has for us.

13. God shows himself to Isaac (Genesis 26:1~26:35)

Dear friends, let me tell you about how much God loved and blessed Isaac. When there was a famine, life became very difficult, so Isaac moved to Gerar, where there was good land. However, he was afraid of the people there, so he told a lie, saying that his wife Rebekah was his sister. Perhaps he thought someone might harm him, and that's why he lied.

But our loving God felt compassion for Isaac, who lied out of fear. God made the king notice that Rebekah was actually Isaac's wife, so the people wouldn't harm him. God helped Isaac prosper there, and he became even wealthier. Eventually, the king asked Isaac to leave, maybe because he became too rich and the king was afraid.

Our friends, those whom God blesses will always live in blessings. We are all God's blessed children, so we should enjoy the blessings He gives us. Isaac dug wells wherever he went, but bad shepherds took them away. However, Isaac didn't give up. He believed in God's blessings and kept digging wells in different places. Eventually, God moved the hearts of the bad shepherds, and the king's servants acknowledged that God loved and blessed Isaac.

Now, no one troubles Isaac, and he enjoys a happy life in the land God commanded. We, too, can overcome any challenges with faith in God's love and promises, just like Isaac did. Jesus, who loves us, is with us, so we shouldn't be afraid. We are God's blessed children.

14. Jacob and Esau. Twins of Isaac (Genesis 25:19~25:34, 27:1~27:23)

Dear friends, through the stories of Esau and Jacob, we have seen the consequences of lying and deception, leading them to live very different lives. Isaac prayed fervently to God when he had no children. Then, twin sons were born to him. The older son, Esau, grew up to be a skilled hunter, and it seemed that Isaac loved him more. The younger son, Jacob, was loved more by his mother. It appears he understood mother better and spent more time with her.

As Isaac grew old and wanted to bless his firstborn before he died, he asked Esau to bring him tasty food from his hunting. This was to give him the blessing meant for the firstborn, as God had intended. However, before that day, Esau was once very hungry from hunting, and he saw Jacob cooking a lentil stew. Esau, without thinking about the importance of the blessing, traded it to Jacob for a bowl of stew. It was a big mistake for Esau to carelessly give away God's blessing without even praying to God.

As a result, Esau lost the blessing meant for him, and Jacob received it instead because of the lentil stew exchange. Our friends, let's never discard the blessings that God gives us. God's blessing is the salvation that Jesus brings to us. If we repent of our sins and believe in Jesus, God forgives us and we become His children, with the blessing of going to heaven. Whatever happens, we must believe in Jesus, repent of our sins, and strive to live as God's children. This is the greatest blessing we can receive.

Let's cherish this blessing by attending church on Sunday and living according to word of God. It is a blessing that we must always keep in faith. Don't miss the chance to be with God until the day we go to heaven.

15. Jacob receives the blessing (Genesis 27:24~28:5)

Jacob pretended to be Esau and received Isaac's blessing. Esau felt very upset with Jacob for taking the blessing. But Jacob wanted the blessing so much that he bought it from Esau with a bowl of lentil stew. By doing this, he could also get Isaac's blessing. Although he lied to his father, he had already bought the rights of the firstborn from Esau. This is something our friends should think about.

God sent Jesus to this world so that we could have authority as his children. If we believe in Jesus, repent for our sins, we will all be saved and can go to heaven.

Also don't forget how Lot's wife turned into a pillar of salt because she looked back. Let's be careful to just follow God's rules and be praised for being faithful children of God. Let's try to receive God's love every day.

Even if our family follows different religions, like Jacob buying the blessing with porridge, we must receive the blessing of salvation and become God's children. So, no matter what happens, we should never let anyone take away the blessings God has given us as His children. We need to share the blessing of becoming God's children with our whole family. Although Esau had his blessing taken away, we will faithfully believe in Jesus, worship, and keep His word, praying that we will receive the best blessings from God, the blessing of being his children.

Just like Jacob received the blessing, we can receive God's prepared blessings with faith, following His word diligently, and living as faithful children every day. Let's make God happy through our worship today.

16. Jacob met God in Bethel (Genesis 28:10~29:14)

Our beloved children, Jacob met God in a dream, and God promised him blessings. When Jacob woke up, he prayed and thanked God. He set up a pillar and named the place Bethel, where he received the blessing. He promised to make it a place of worship, and also he promised to give a tenth of all he had as an offering to God.

With God's guidance, Jacob met his uncle and started living a blessed life at his uncle's house. When Jacob was afraid, God assured him with blessings in his dream. Jacob showed his faith through his actions. He wanted to turn the place of his dream into a place of worship to demonstrate his love for God. Just like Jacob, our friends should also make an effort to meet God. When we gather for worship, we must focus with all our hearts, love God, and seek to meet Him. The Bible tells us that God sees and accepts our worship, even though we cannot see Him. He responds to our prayers. That`s why we can truly meet God during worship services. Isn`t it wonderful knowing that we could feel his presence during the service?

So, we should cherish this precious time of worship and never miss it. Let's love it and share it with our family and friends so that they can also meet God through worship service. Let's declare our love for God loudly in today's worship. Our God will be so pleased.

17. Jacob stays in blessing of God (Genesis 29:14~30:26)

God blessed Jacob while he stayed at his uncle's house, allowing him to get married and live a prosperous life. However, Jacob missed his parents and wanted to return home. His uncle was setting a way to receive property and Jacob asked to give him those speckled and spotted sheep and goats. Then, he ended up having many speckled and spotted ones. Then his uncle blessed him, and Jacob left with his wife, servants, and a lot of animals to return home.

When Jacob's heart grew anxious, God sent an angel to reassure him that God would be with him. Upon hearing this, Jacob could leave his uncle's house. His uncle's household served other gods, so God blessed Jacob and helped him leave that place to support his faith. Although Jacob's uncle followed after him, God moved his heart not to harm Jacob and let him go safely.

Dear friends, remember that God sees us anytime, anywhere, and He remembers us, desiring us to walk on the path of blessings and faith. Even when we face difficulties and hardships, Jesus is always with us, and the Holy Spirit dwells within us. God sent Jesus to us, and after Jesus rose to heaven, He sent the Holy Spirit to be with us. So, we are not alone; we can live as beloved children of God. Let's pray, worship, and live according to His word every day, praying to live as blessed children. Our God will answer our prayers.

ACTIVITIES AND GAMES

1. Fish of GOD's Creation

Making a Fish with paper plate and draw each day of God`s creation on scales of the fish.

2. Paper-cup basketball

Make a paper-cup basket with stick and connect the paper ball by string.

3. Balloon relay game

Set two teams and play the balloon relay game

4. What do you like to give to God?

Draw a gift to God on a piece of paper. Place on top of head and walk to the basket to drop it well.

5. Making a Ark of Noah

Making a Noah`s story plate using two pieces of paper(color paper).

6. Paper-cup relay game

Place paper-cup on your hand and do the relay game.

7. Board of ten commandments

Making a board of Ten Commandments to remind the words of GOD

8. Memorizing game of words of GOD

Prepare words cards and number cards and play mix match game

9. Making a flower name card

Let`s write our name on beautiful flower name card and remember that God call our name as his children.

10. Tug of war

Prepare a long rope and play a team game.

11. Making a cup basket

Make a basket with cup and put your precious things to give to God.

12. Flower mask

use paper plate and color papers to make a flower mask.

13. Making a Fan

Feel the breeze and remember how great the blessing of God is.

14. Game of chicken fight

Hold your one leg with hand to play. Find the winner of the game

15. Bug race

Fold the bug and place race using thread.

16. Our Board game

Make a board and dice to play game in groups.

17. Flying spintop

Let`s make spintop and throw up to see flying down.

FEEDBACK

01

- a) What is your favorite thing from God`s creation. Why is it your favorite?
- b) Which place among the God`s creation do you like to travel with your family? What do you want to do there?

02

- a) Which part of your body that you appreciate the most and like to thanks to God?(ex. Good eyesight)
- b) What is your favorite animal from God`s creation? What do you like to do with your favorite one?

03

- a) Is there anything that you didn`t complete it while just giving excuses? Let`s share it.
- b) What should I do more to not to think or say out excuses?

04

- a) What do you like to do to make our God happy?
- b) What kind of effort do you have to make our God happy?

05

- a) Have you ever obey words of God just as Noah did? What was it about?
- b) Is there any prayer list that you are still waiting the answer from God? which one do you think you still have to wait longer?

06

a) Were there any promise that you said to God? Did you accomplish any of that? What was it?

b) Is there anything that you promise to God in these days? What do you have to do to accomplish your promise to God?

07

a) What is the hardest commandment you feel difficult to follow?

b) Let`s read the 10 commandments altogether.

08

a) Let`s share what kind of blessing you`ve received after you met Jesus.

b) Just as Abram, will you be able to give up any of your precious thing to share the gospel? How do you feel about it? Let`s share out or draw it.

09

a) Remembering God work through Abram, what kind of my image and time will God use for his will?

(ex- praying time, obeying the words of God, and Praising Lord)

b) Do I have faith like Abraham to worship God?

10

a) Is there any bad habit of mine that Jesus would not like? Let`s share and pray to repent it.

b) Is there a person of faith that I admire? What do you want to learn from him?

11

a) Do I have the faith to keep Sunday worship no matter what the circumstances? Let`s pray all together to have that faith.

b) Just like Abraham's obedience, what kind of faith do I want to keep for Jesus?

12

a) Is there any prayer that you like to be answered by Jesus? Let's share and pray for each other's prayer.

b) To whom do you like to share a gospel and bring to worship service? What kind of effort do you do for him or her?

13

a) How many pages of bible, the word of God, do you read every day? If you don't read it daily, how much do you want to read starting tomorrow.

b) Is there anything from your own that you're worried about losing it? Let's share it.

14

a) What are the blessings that you received from God. Let's share it.

b) What is the greatest blessing I want to receive from God?

15

a) What was the biggest lie that I ever say in front of God? Let's repent it this time.

b) What are some of the things you're most grateful for when you were forgiven by your parents?

16

a) What do you do when you are most afraid of something?

b) Let's share now that God is with us. What was your experience?

17

a) What blessings has God given me?

b) If I hadn't met Jesus, what would I have lost the most?

COLORING ACTIVITY

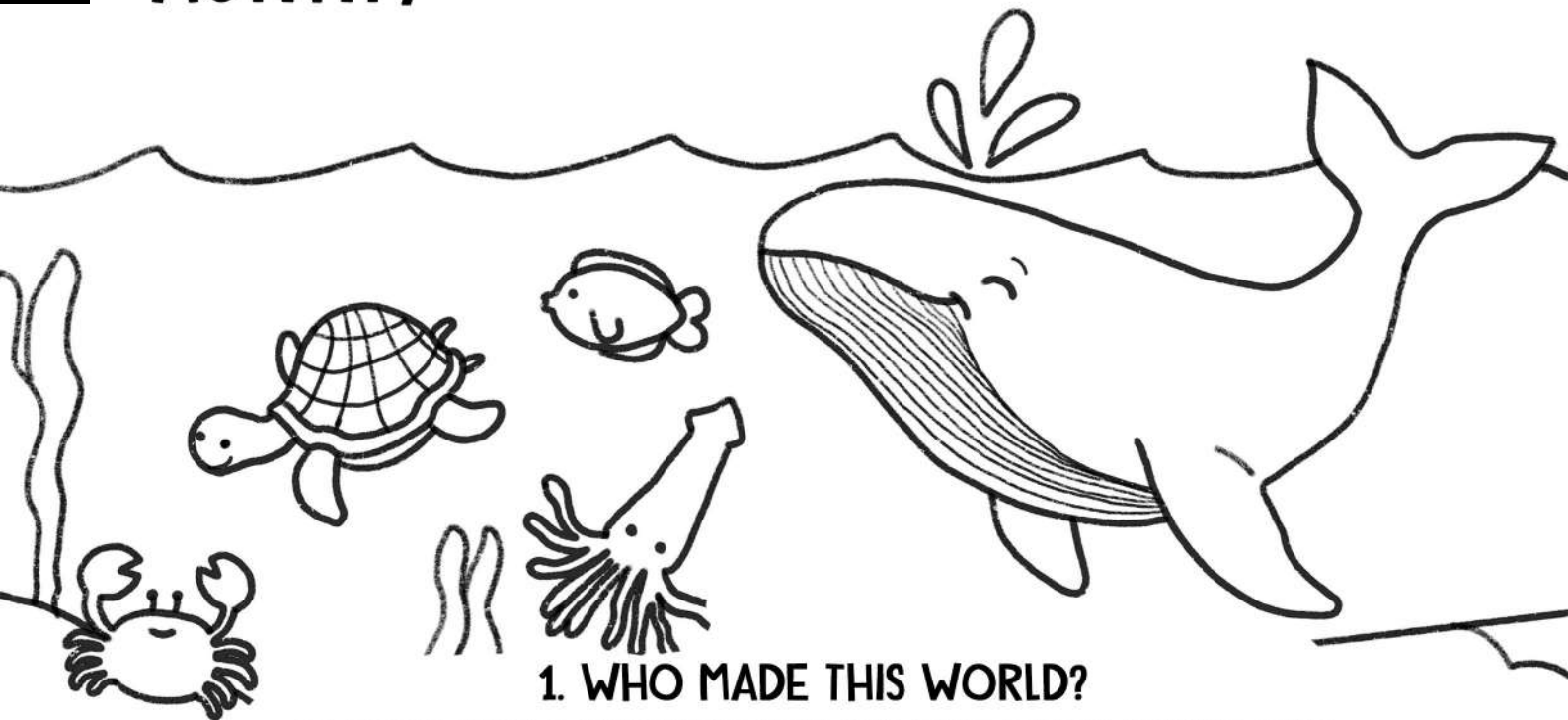

1. WHO MADE THIS WORLD?

THEN GOD BLESSED THE SEVENTH DAY AND MADE IT HOLY, BECAUSE ON IT
HE RESTED FROM ALL THE WORK OF CREATING THAT HE HAD DONE.

GENESIS 2:3



2. ADAM AND EVE

AFTER HE DROVE THE MAN OUT, HE PLACED ON THE EAST SIDE OF THE GARDEN OF EDEN CHERUBIM AND A FLAMING SWORD FLASHING BACK AND FORTH TO GUARD THE WAY TO THE TREE OF LIFE. GENESIS 2:24

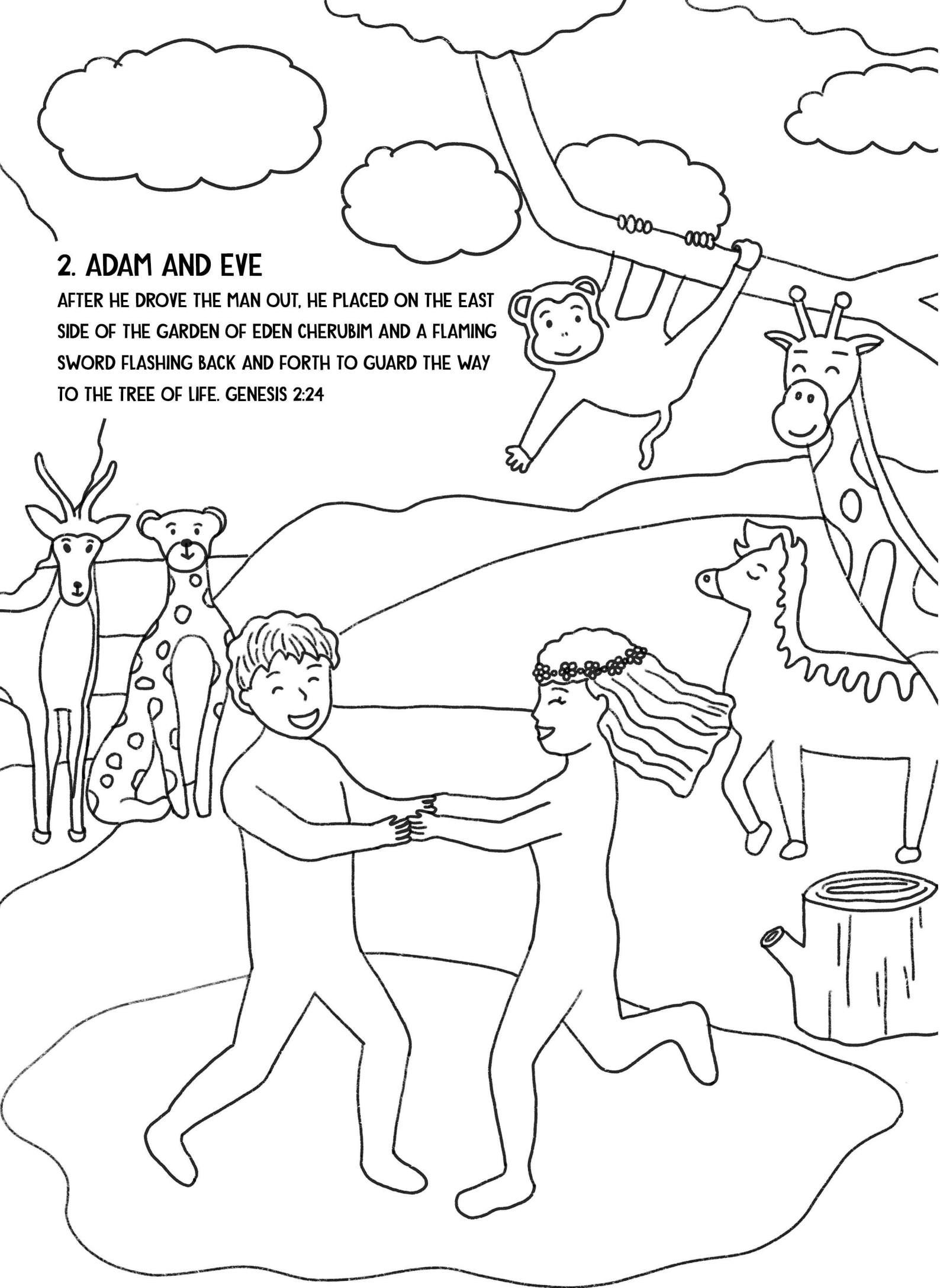

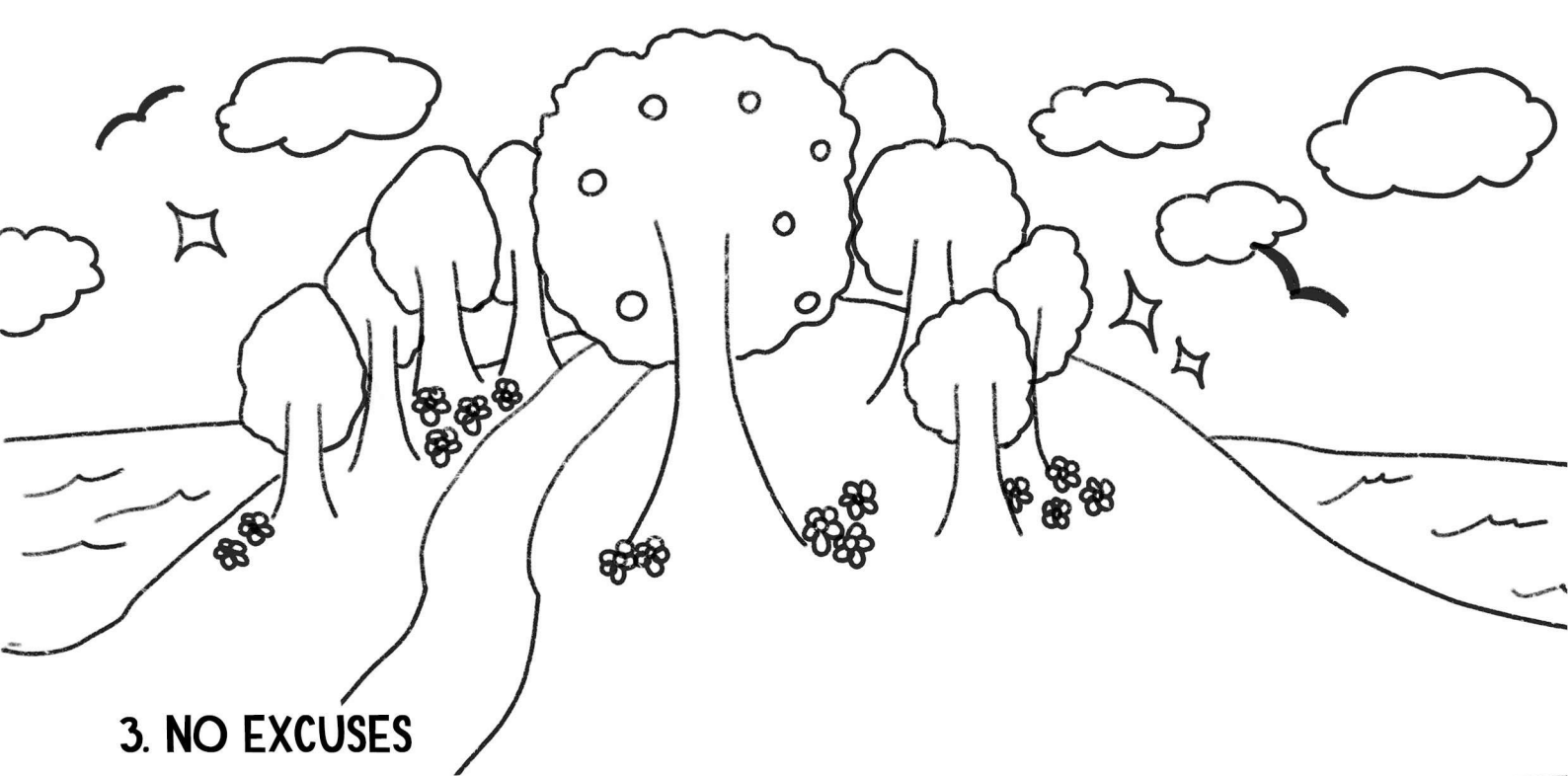

3. NO EXCUSES

THE LORD GOD MADE GARMENTS OF SKIN FOR ADAM
AND HIS WIFE AND CLOTHED THEM. GENESIS 3:21



4. CAIN AND ABEL

IF YOU DO WHAT IS RIGHT, WILL YOU NOT BE ACCEPTED?
BUT IF YOU DO NOT DO WHAT IS RIGHT, SIN IS
CROUCHING AT YOUR DOOR; IT DESIRES TO HAVE YOU,
BUT YOU MUST RULE OVER IT." GENESIS 4:7



5. NOAH

NOAH DID EVERYTHING JUST AS GOD COMMANDED HIM.

GENESIS 6:22

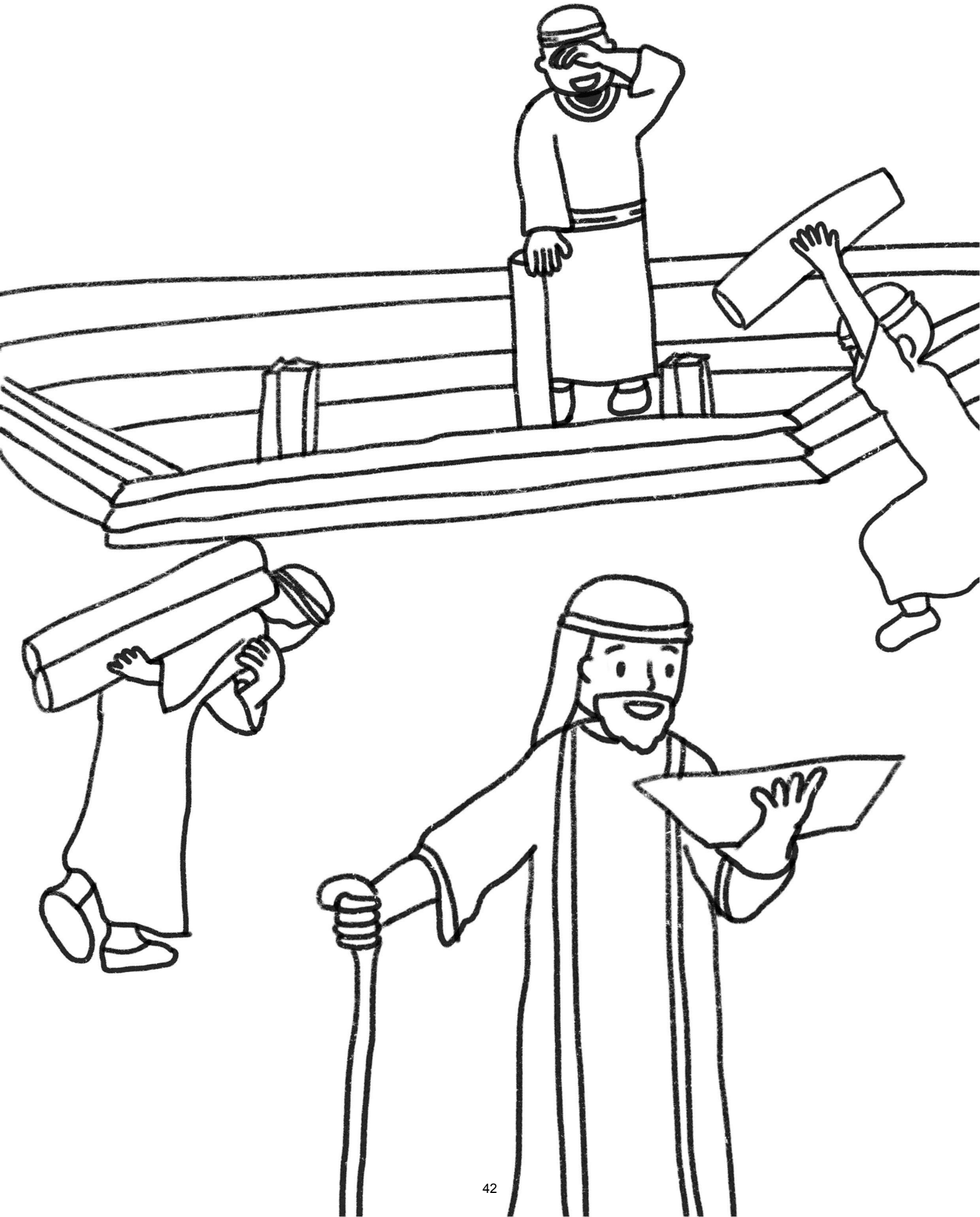



6. THE FLOOD AND THE RAINBOW

I HAVE SET MY RAINBOW IN THE CLOUDS, AND IT WILL BE THE SIGN OF THE COVENANT BETWEEN ME AND THE EARTH. GENESIS 9:13



7. THE TOWEL OF BABEL

THAT IS WHY IT WAS CALLED BABELICJ-BECAUSE THERE THE LORD CONFUSED THE LANGUAGE OF THE WHOLE WORLD. FROM THERE THE LORD SCATTERED THEM OVER THE FACE OF THE WHOLE EARTH. 11:9



8. ABRAM, THE ROOT OF EVERY BLESSING

"I WILL MAKE YOU INTO A GREAT NATION, AND I WILL BLESS YOU; I WILL MAKE YOUR NAME GREAT, AND YOU WILL BE A BLESSING."

GENESIS 12:2



9. ABRAHAM, THE NEW NAME OF ABRAM

NO LONGER WILL YOU BE CALLED ABRAM; YOUR NAME WILL BE ABRAHAM.(C) FOR I HAVE MADE YOU A FATHER OF MANY NATIONS.

GENESIS 17:5





10. THE FALLING OF SODOM AND GOMORRAH

SO WHEN GOD DESTROYED THE CITIES OF THE
PLAIN, HE REMEMBERED ABRAHAM, AND HE
BROUGHT LOT OUT OF THE CATASTROPHE THAT
OVERTHREW THE CITIES WHERE LOT HAD LIVED.

GENESIS 19:29

**11. SACRIFICE YOUR SON ISAAC
AS AN OFFERING**

SO ABRAHAM CALLED THAT PLACE THE LORD
WILL PROVIDE. AND TO THIS DAY IT IS SAID, "ON
THE MOUNTAIN OF THE LORD IT WILL BE
PROVIDED." GENESIS 22:14



12. MARRIAGE OF ISAAC AND REBEKAH

ISAAC BROUGHT HER INTO THE TENT OF HIS MOTHER SARAH, AND HE MARRIED REBEKAH. SO SHE BECAME HIS WIFE, AND HE LOVED HER; AND ISAAC WAS COMFORTED AFTER HIS MOTHER'S DEATH. GENESIS 24:67



13. GOD SHOWS HIMSELF TO ISAAC

THAT DAY ISAAC'S SERVANTS CAME AND TOLD HIM ABOUT THE WELL THEY HAD DUG. THEY SAID, "WE'VE FOUND WATER!" HE CALLED IT SHIBAH, AND TO THIS DAY THE NAME OF THE TOWN HAS BEEN BEERSHEBA. GENESIS 26:32-33

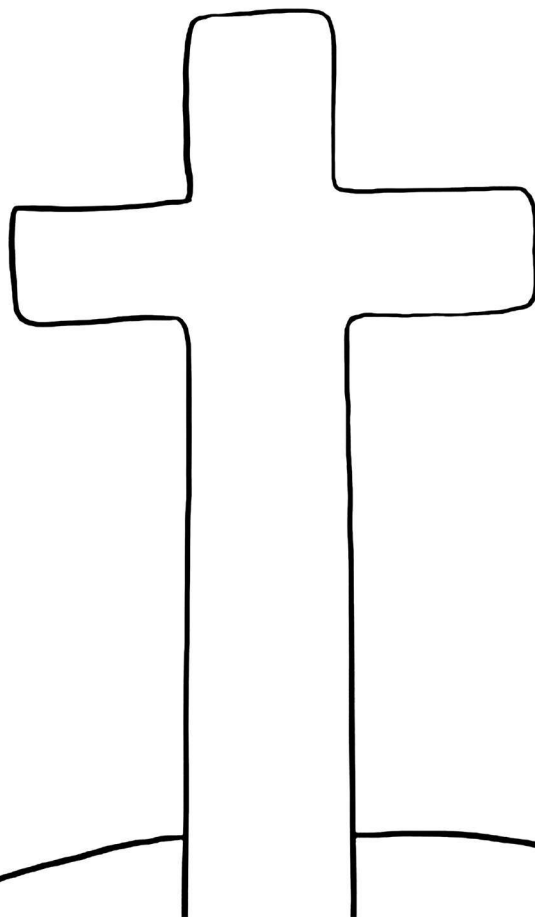

14. JACOB AND ESAU. TWINS OF ISAAC

THEN JACOB GAVE ESAU SOME BREAD AND SOME LENTIL STEW. HE ATE AND DRANK, AND THEN GOT UP AND LEFT.

SO ESAU DESPISED HIS BIRTHRIGHT.

GENESIS 25:34



15. JACOB RECEIVES THE BLESSING

MAY GOD ALMIGHTY[B] BLESS YOU AND MAKE YOU FRUITFUL AND INCREASE YOUR NUMBERS UNTIL YOU BECOME A COMMUNITY OF PEOPLES. MAY HE GIVE YOU AND YOUR DESCENDANTS THE BLESSING GIVEN TO ABRAHAM, SO THAT YOU MAY TAKE POSSESSION OF THE LAND WHERE YOU NOW RESIDE AS A FOREIGNER, THE LAND GOD

GAVE TO ABRAHAM."

GENESIS 28:3-4



16. JACOB MET GOD IN BETHEL

WHEN JACOB AWOKE FROM HIS SLEEP, HE THOUGHT, "SURELY THE LORD IS IN THIS PLACE, AND I WAS NOT AWARE OF IT." HE WAS AFRAID AND SAID, "HOW AWESOME IS THIS PLACE! THIS IS NONE OTHER THAN THE HOUSE OF GOD; THIS IS THE GATE OF HEAVEN."

EARLY THE NEXT MORNING JACOB TOOK THE STONE HE HAD PLACED UNDER HIS HEAD AND SET IT UP AS A PILLAR AND POURED OIL ON TOP OF IT. HE CALLED THAT PLACE BETHEL. (E) THOUGH THE CITY USED TO BE CALLED LUZ.

GENESIS 28:16-19

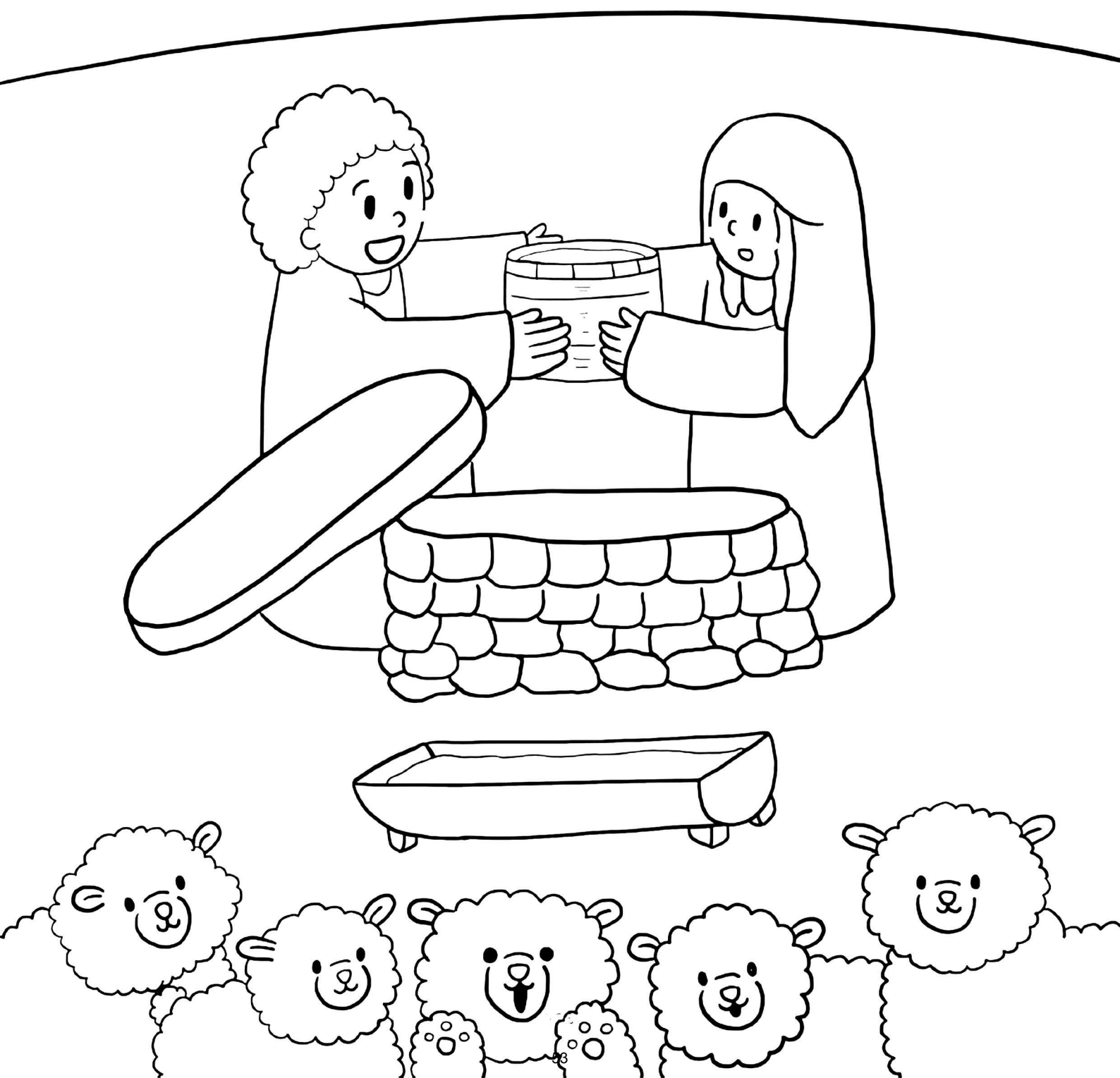

17. JACOB STAYS IN BLESSING OF GOD

SHE BECAME PREGNANT AND GAVE BIRTH TO A SON AND SAID,
"GOD HAS TAKEN AWAY MY DISGRACE." SHE NAMED HIM JOSEPH.[H]
AND SAID, "MAY THE LORD ADD TO ME ANOTHER SON."

GENESIS 30: 23-24



COLORING ACTIVITY

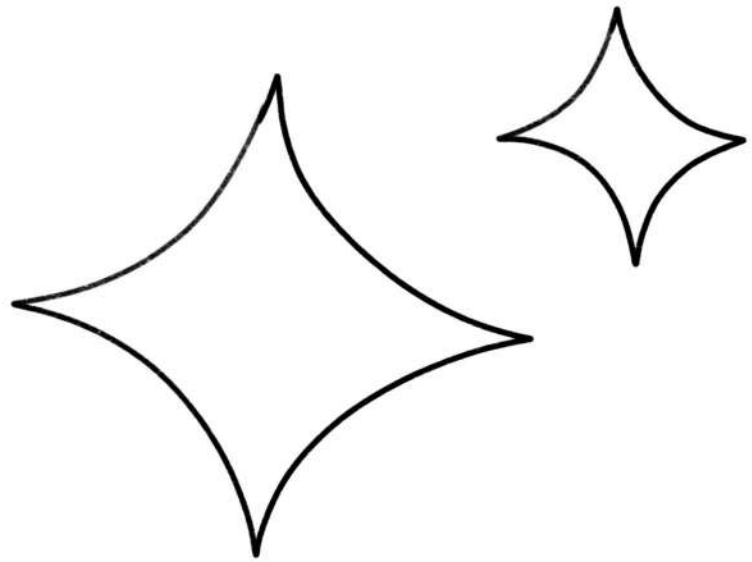

1-1 DAY1

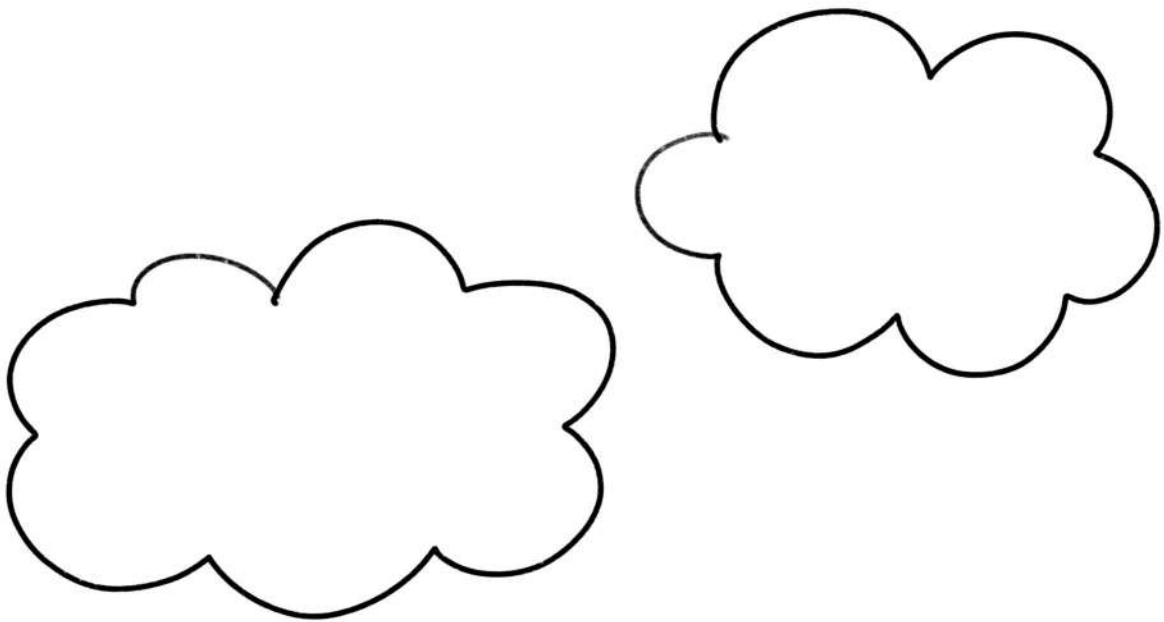

1-2 DAY2

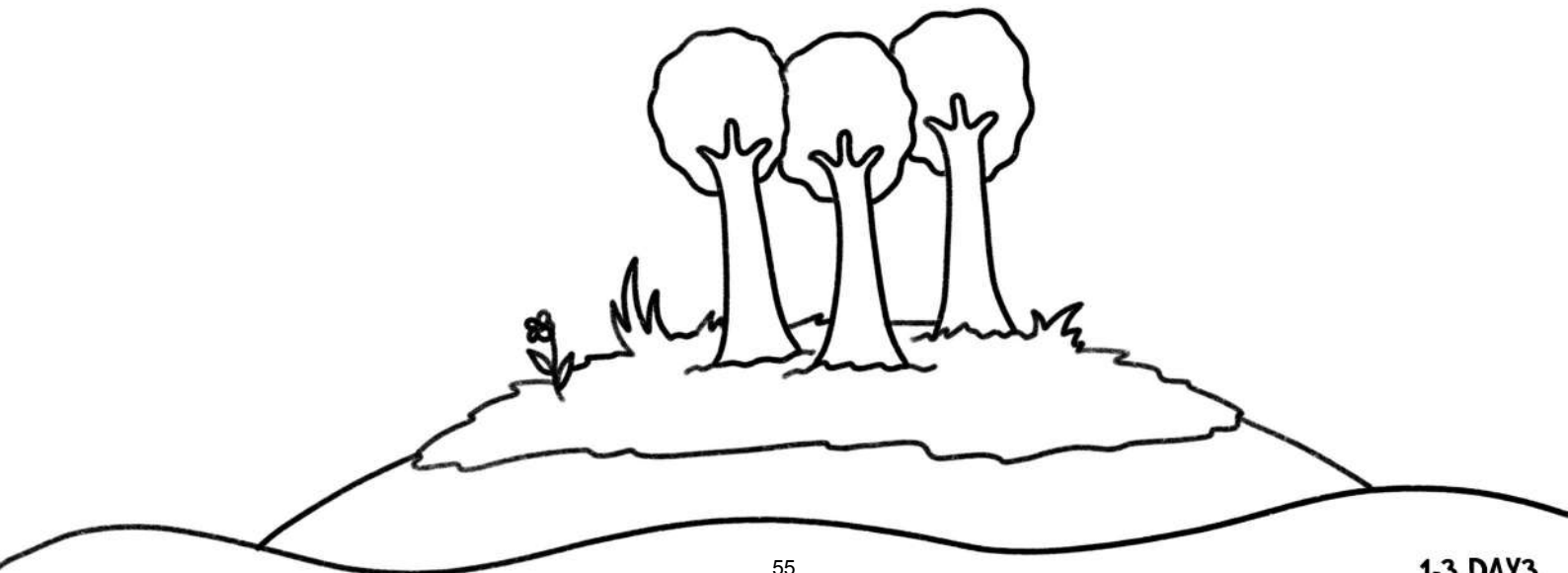

1-3 DAY3

1-4 DAY4

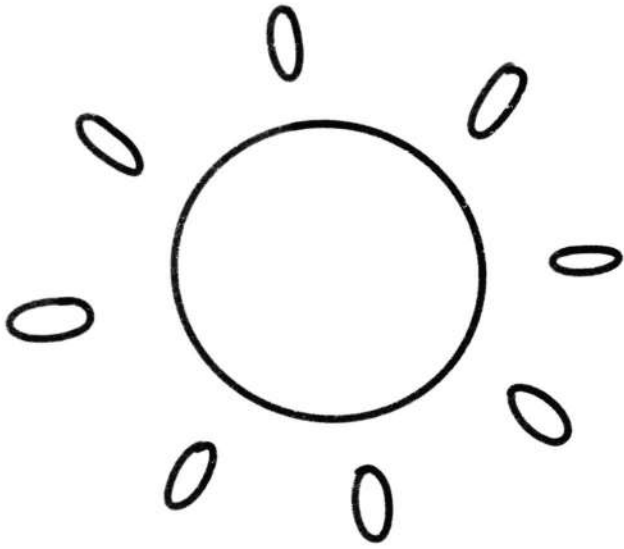

1-6 DAY6

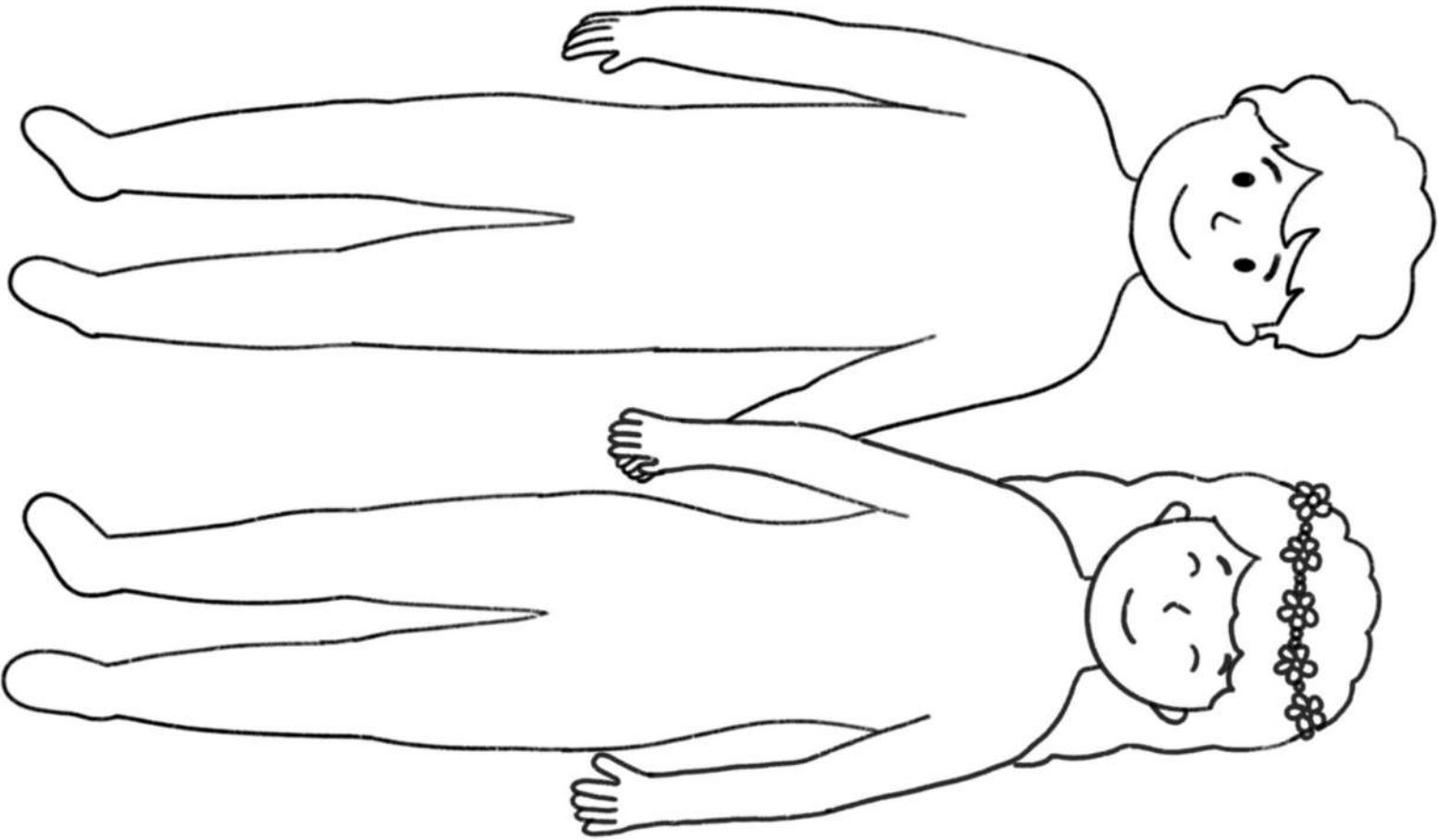

1-6 DAY6



1-5 DAY5

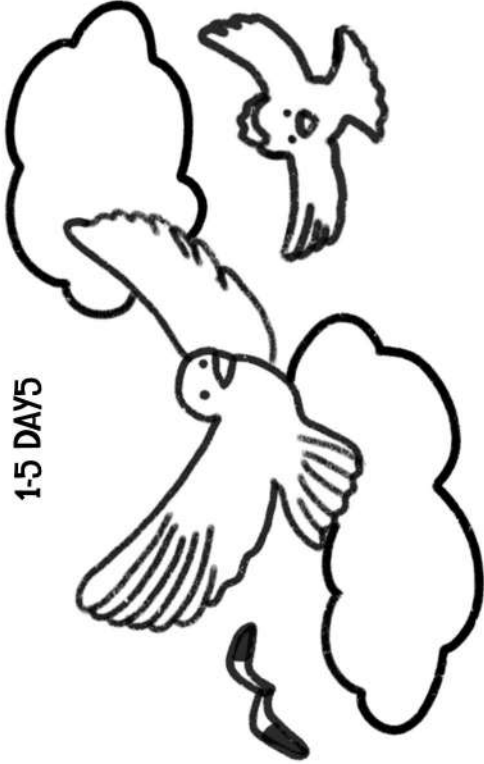

1-5 DAY5

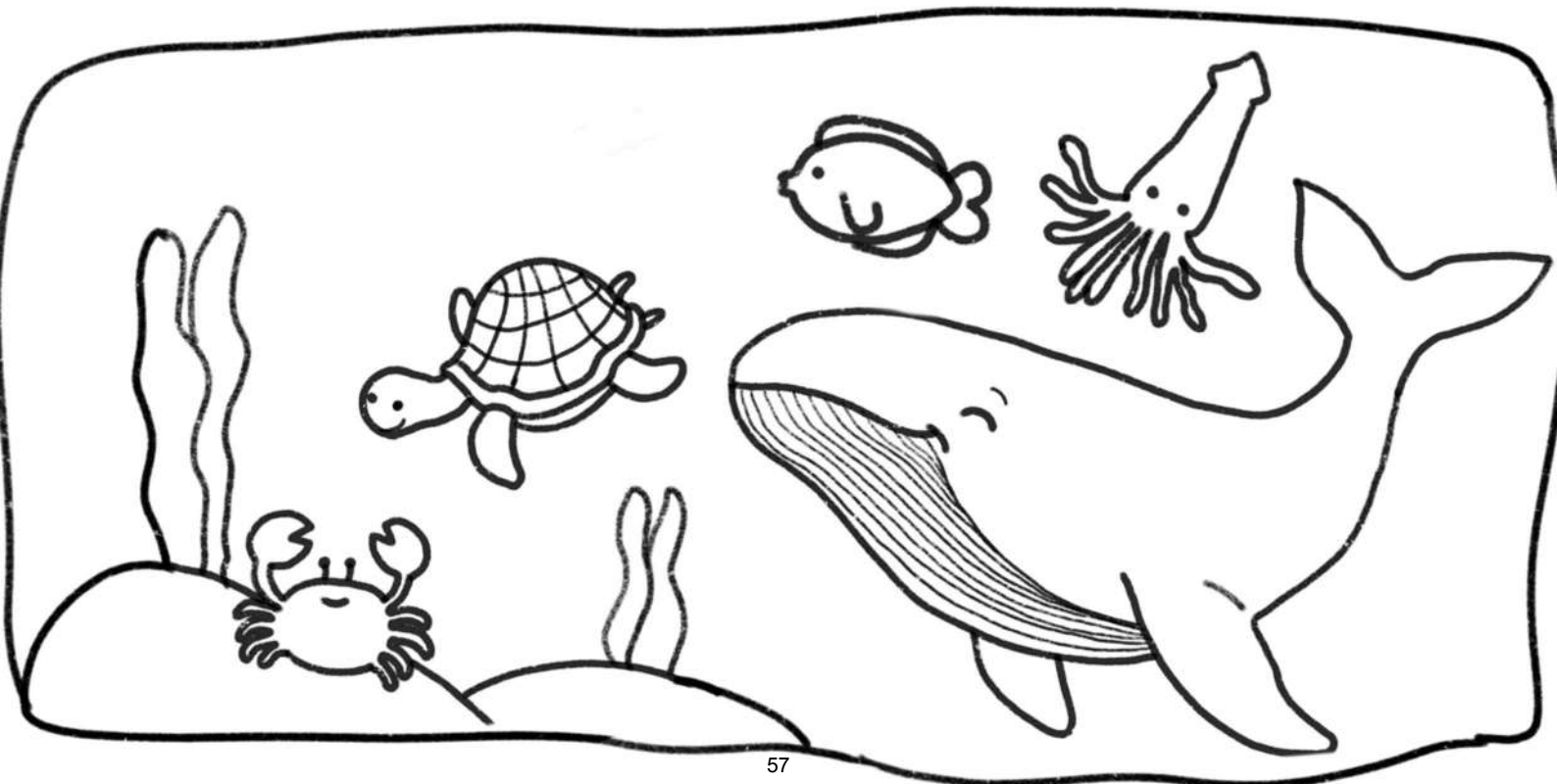

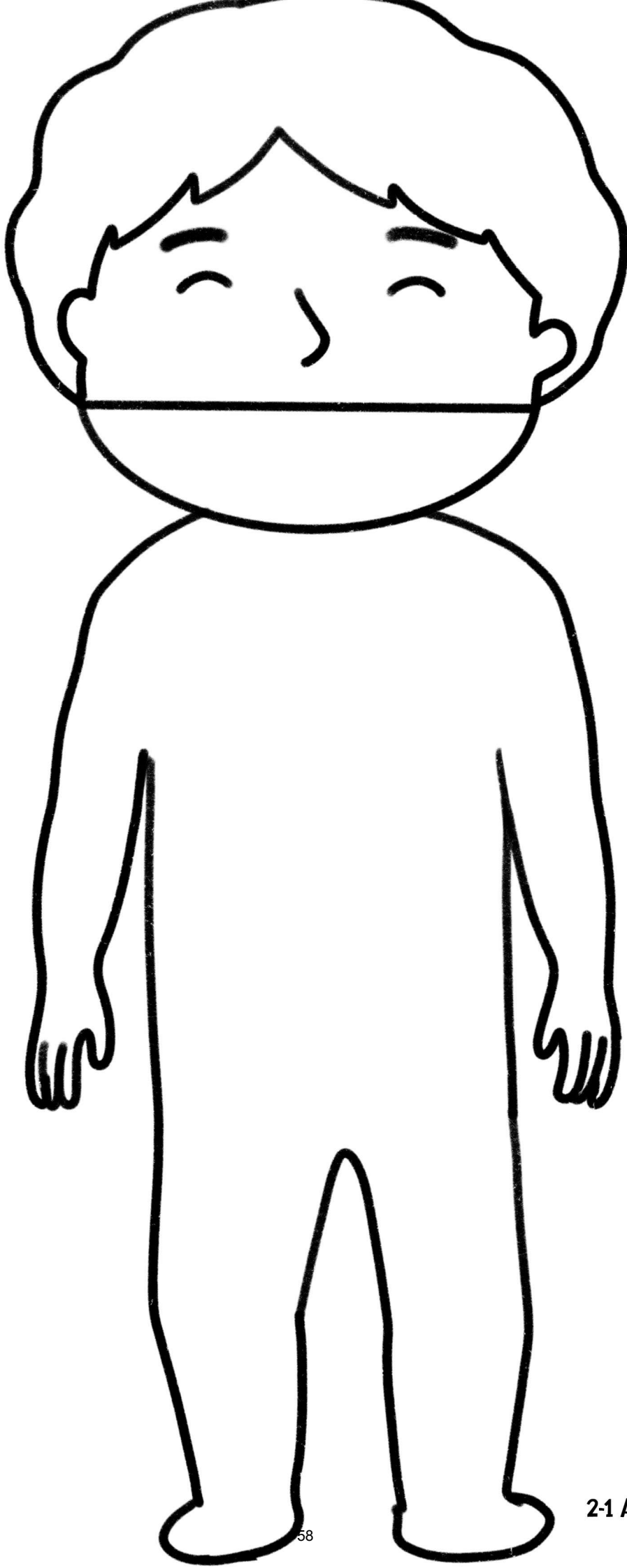

2-1 ADAM

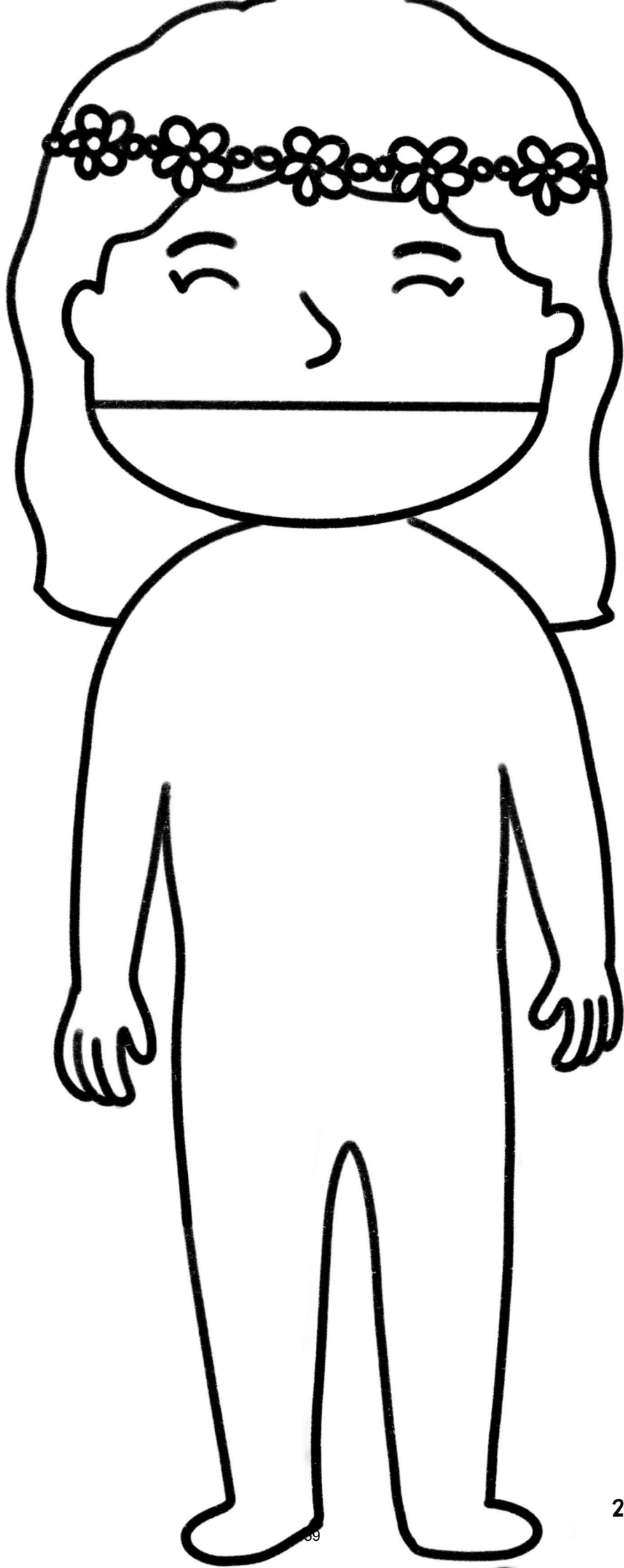

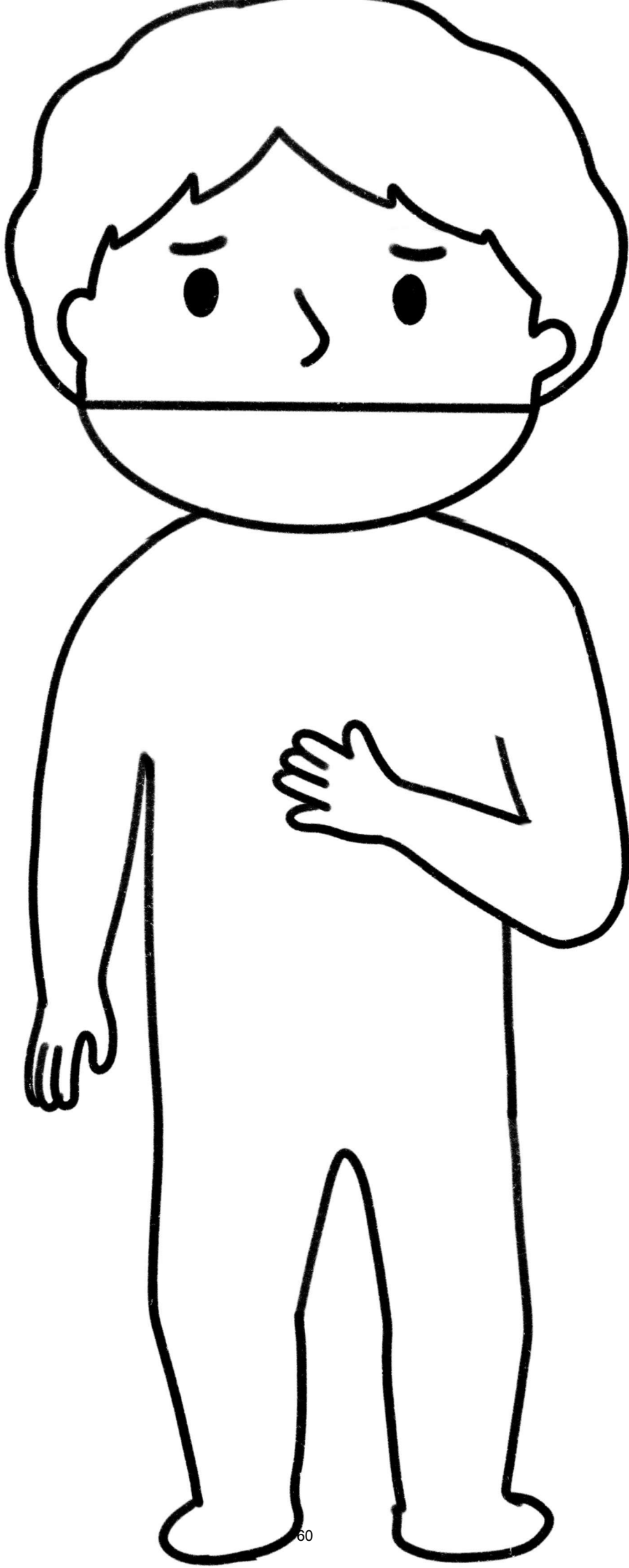

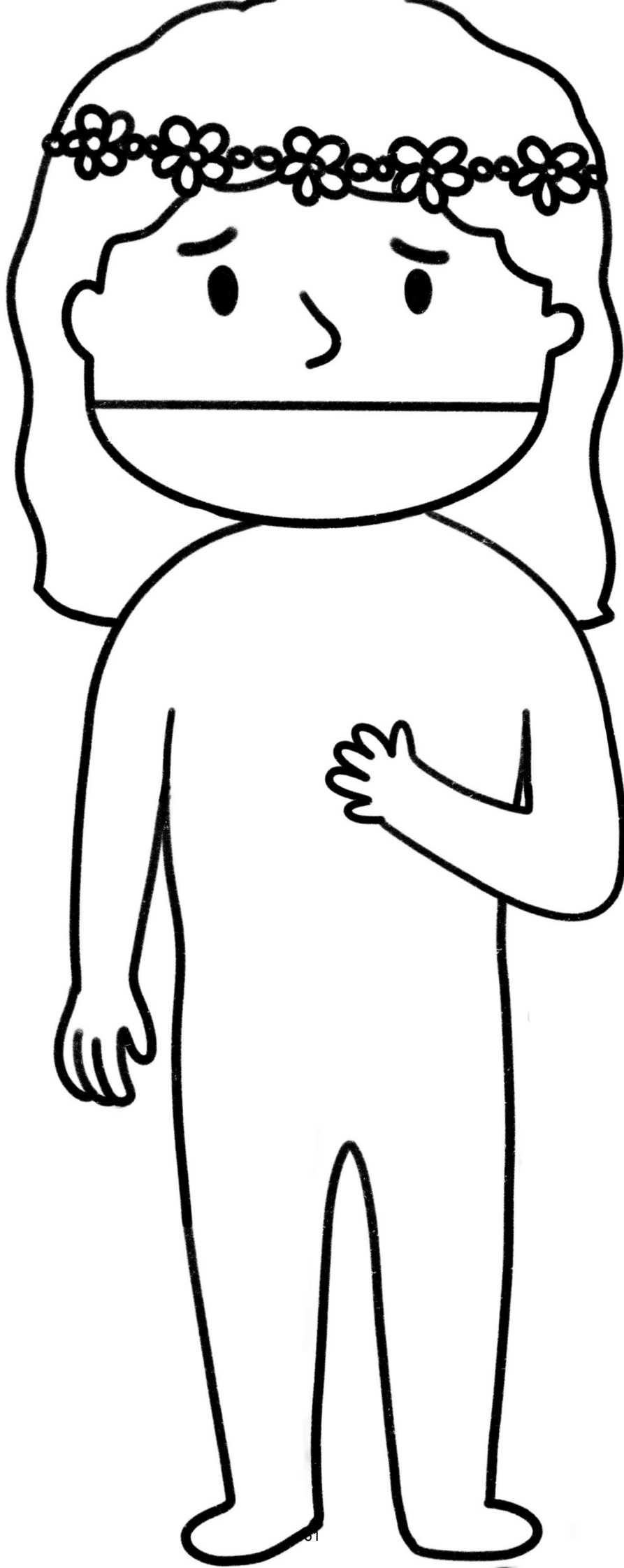

3-3 ADAM CLOTHES



3-3 EVE CLOTHES

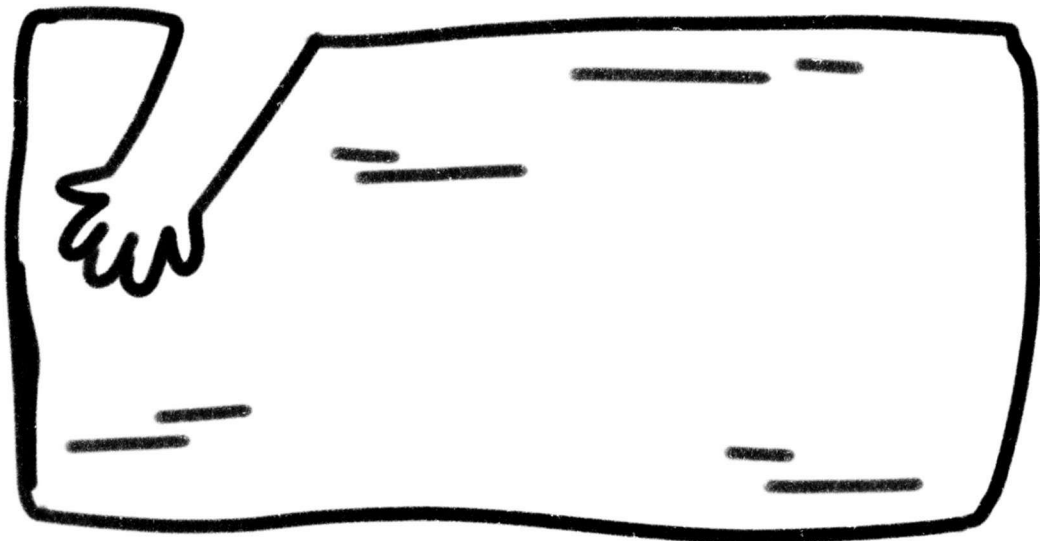

3-4 EVE CLOTHES



3-5

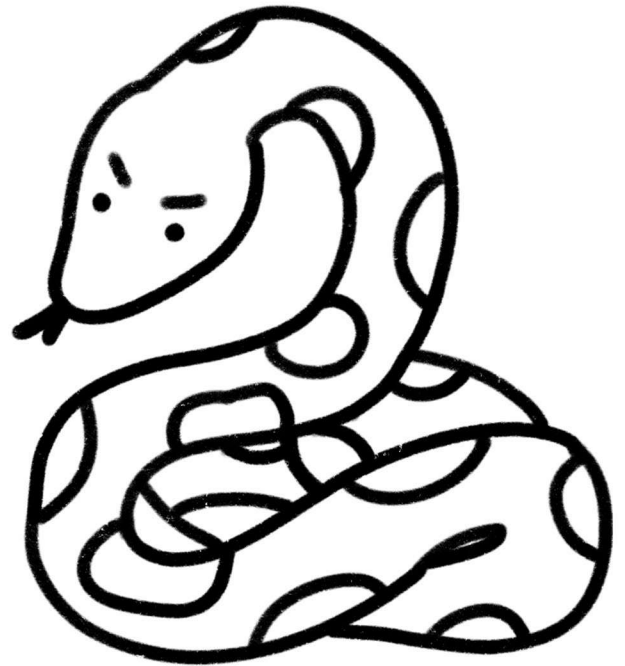
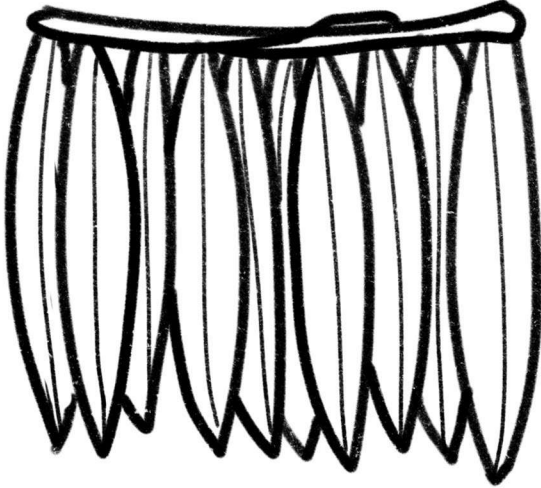

3-6

3-4 ADAM CLOTHES

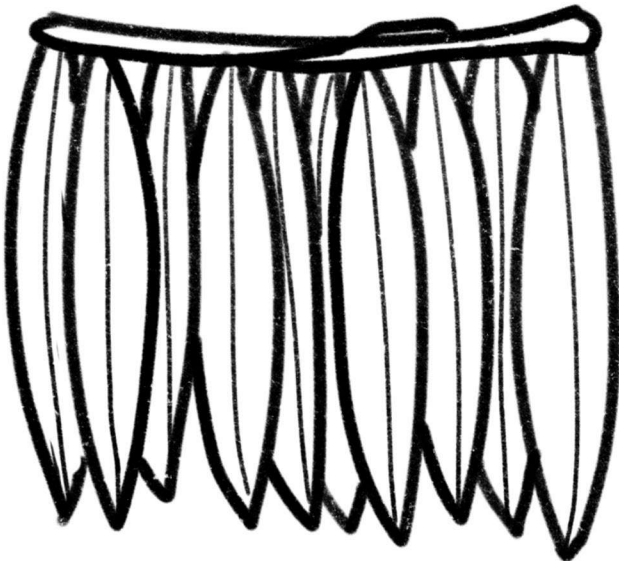

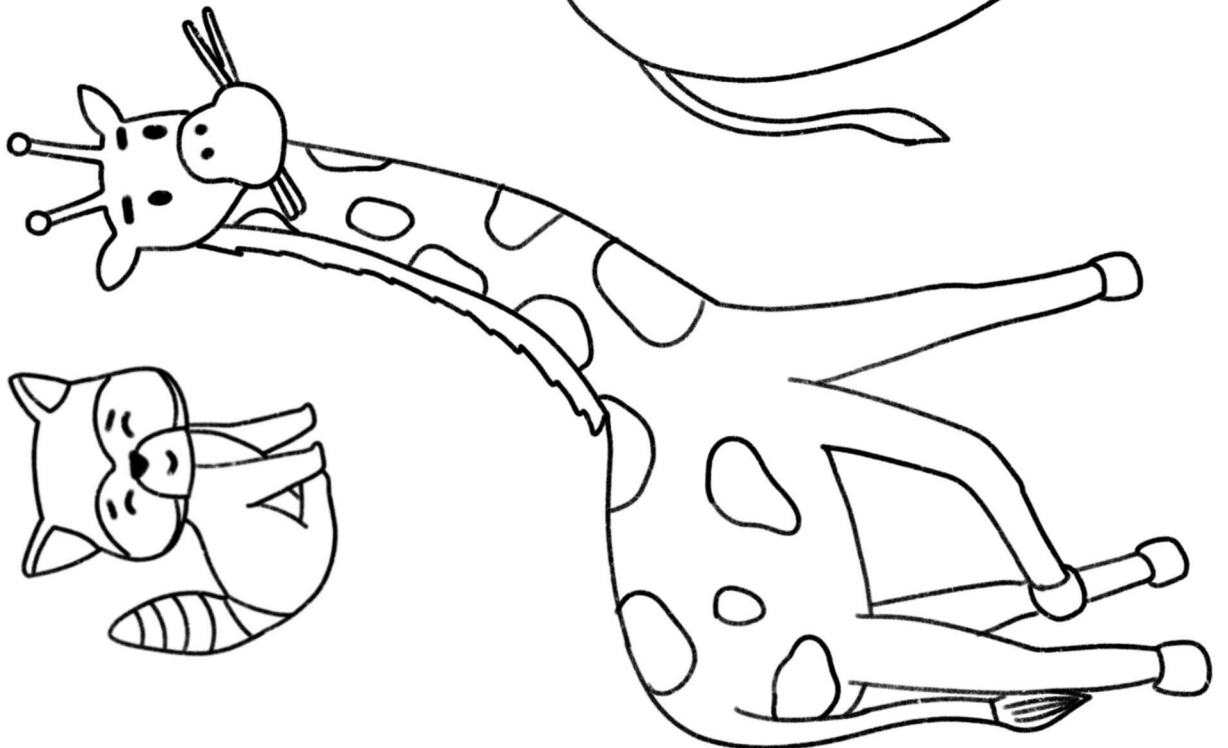
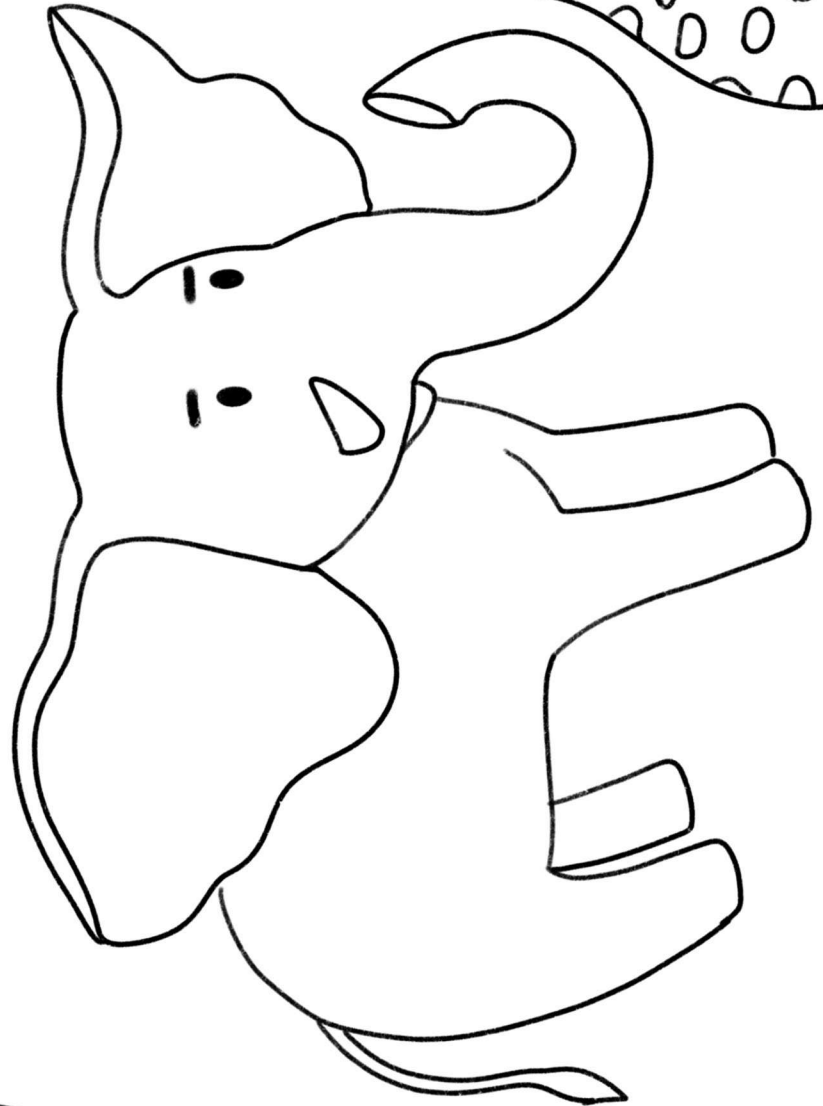
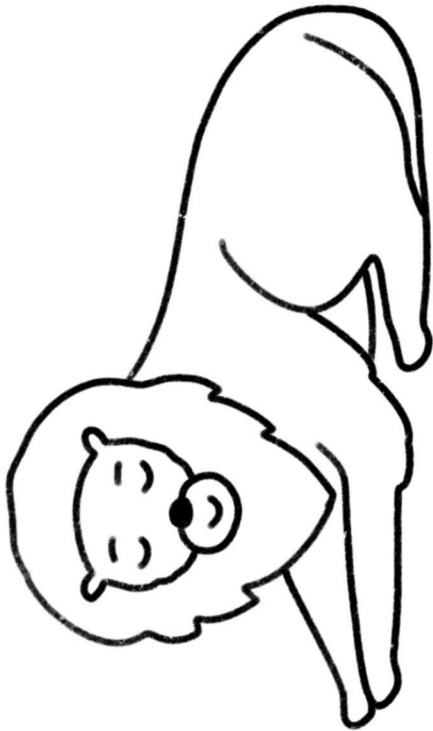
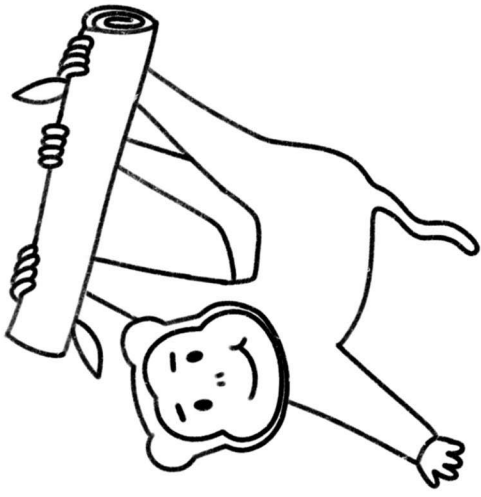

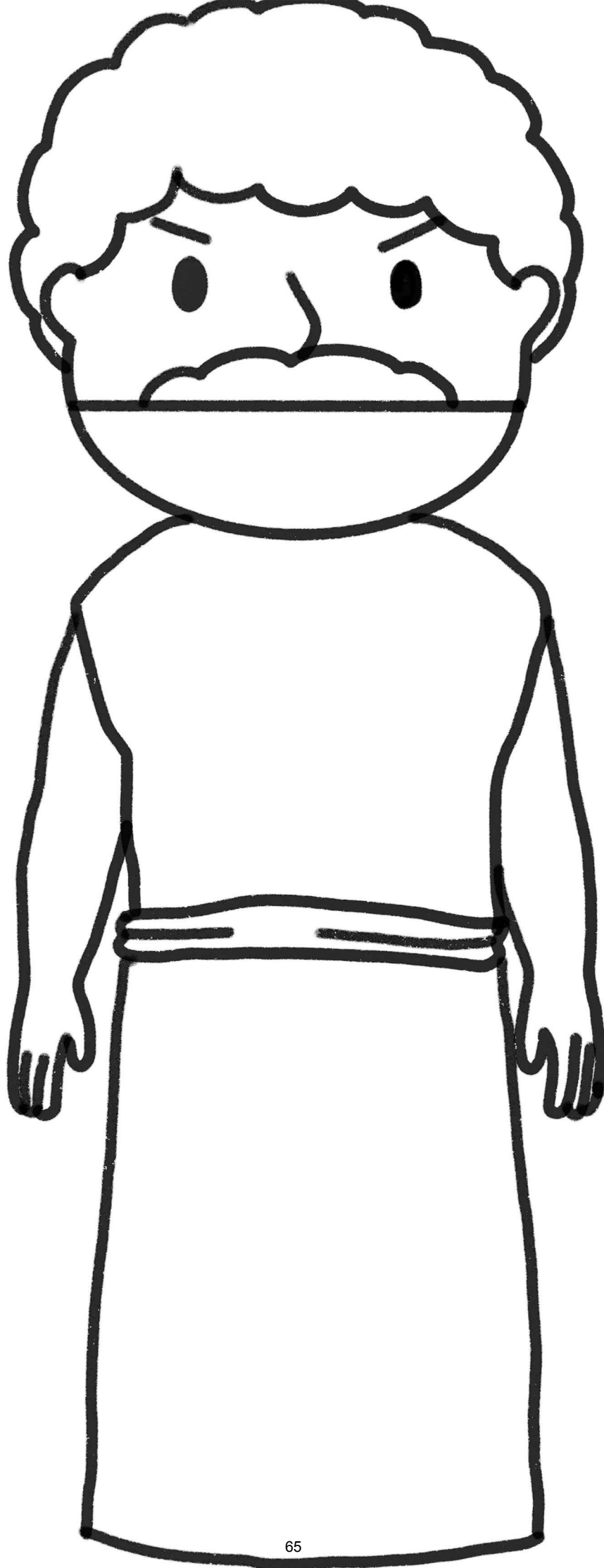

4-1 CAIN

4-2 ABEL

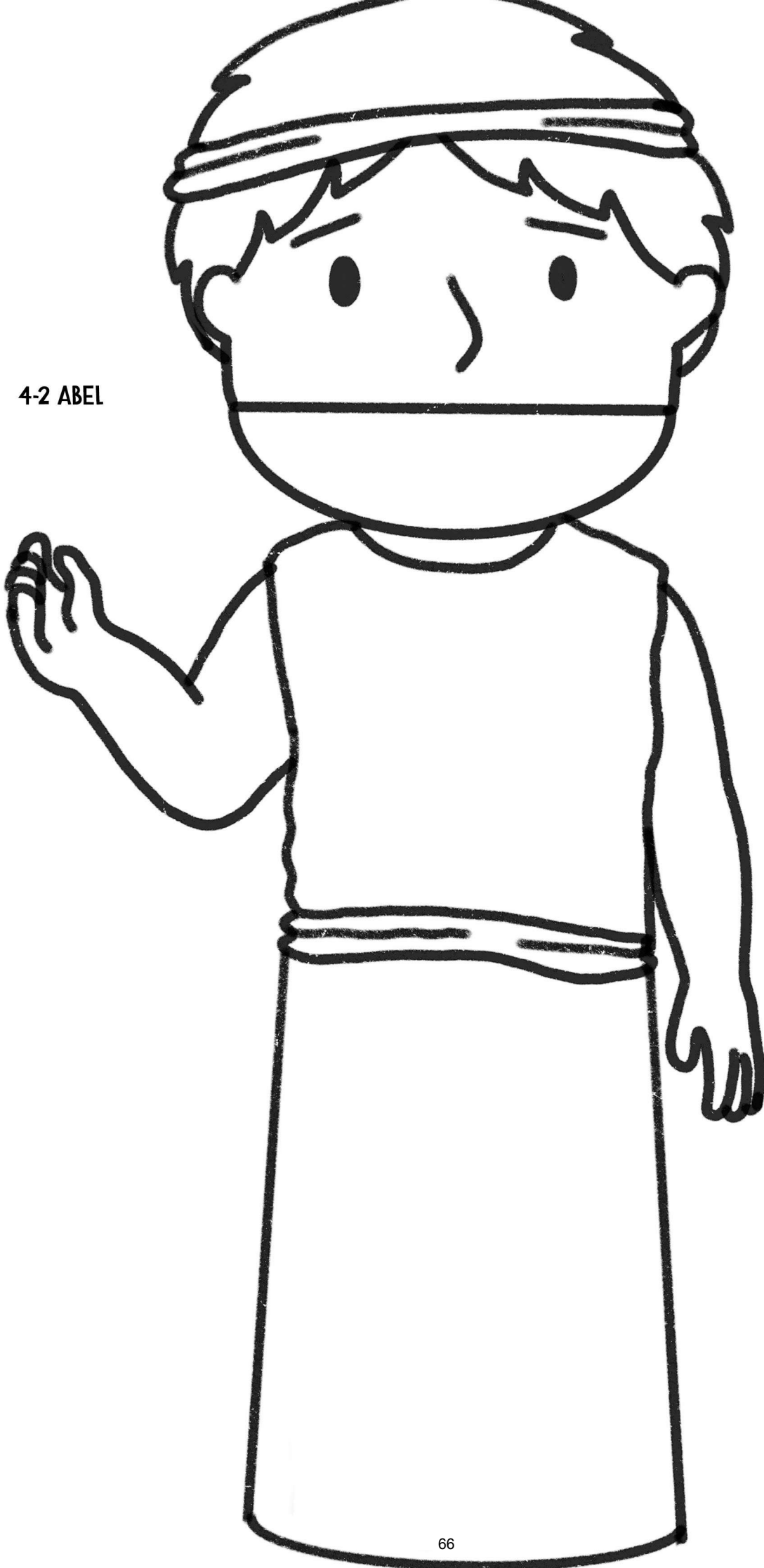

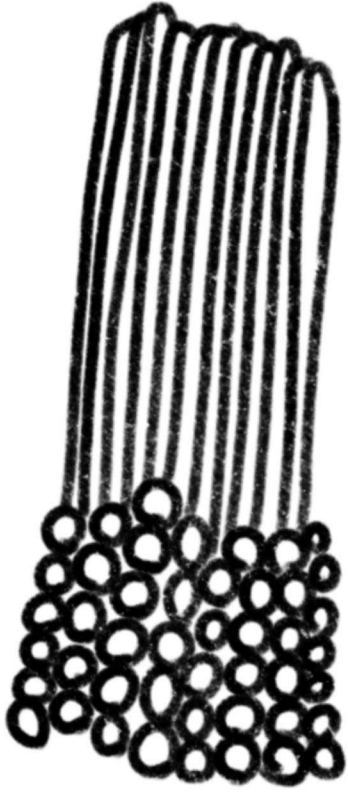

4-4 OFFERINGS

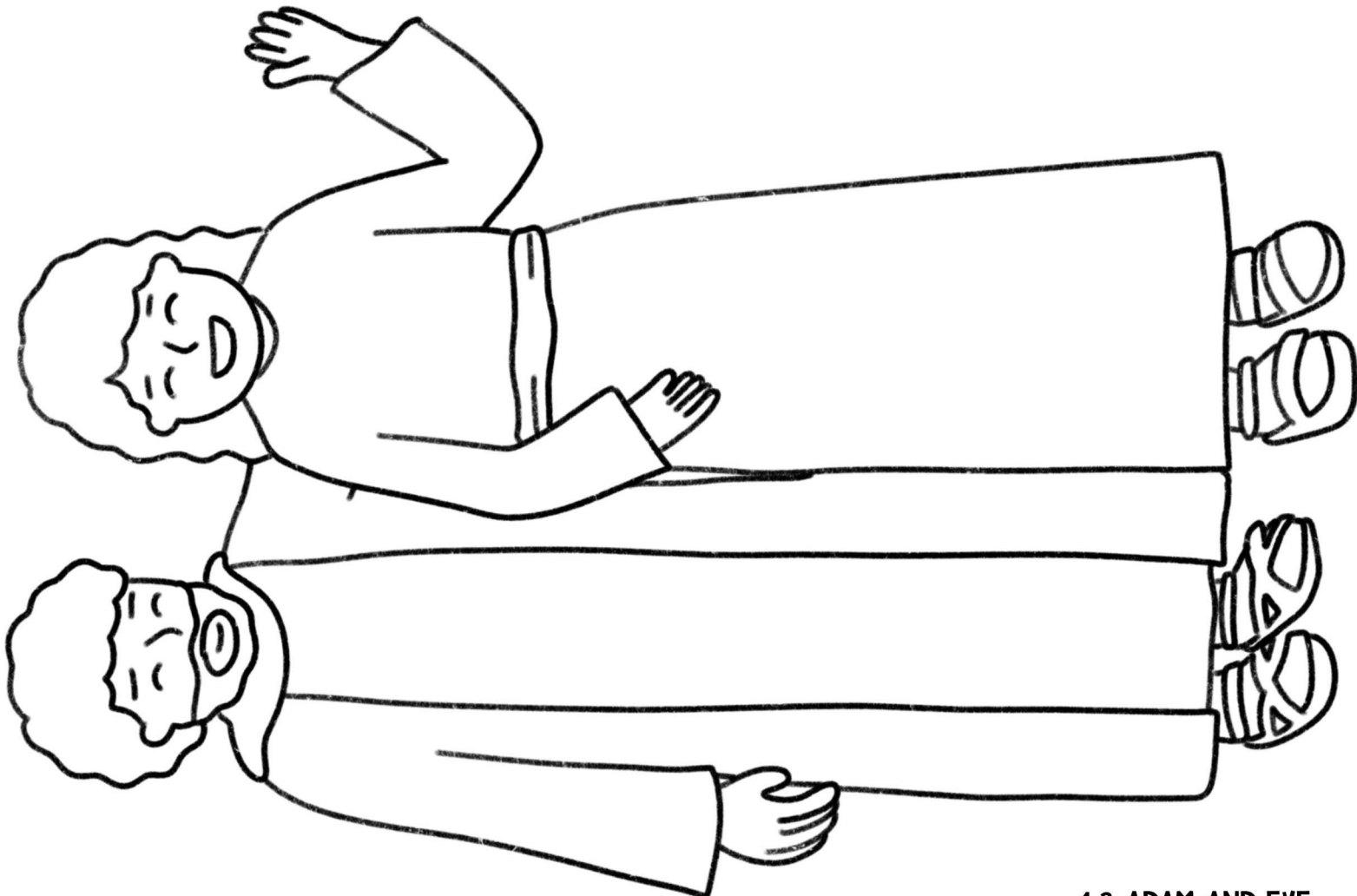

4-3 ADAM AND EVE

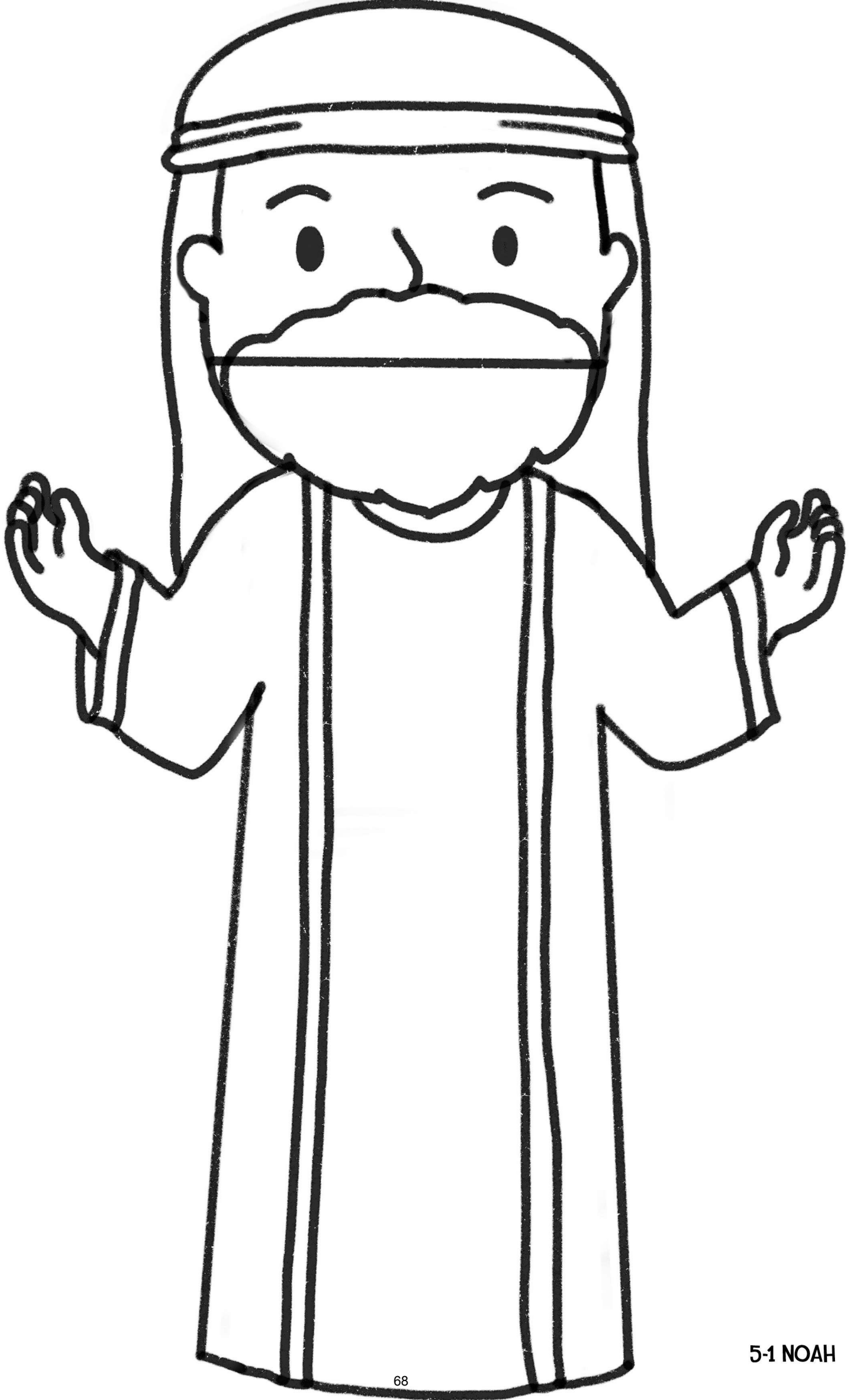

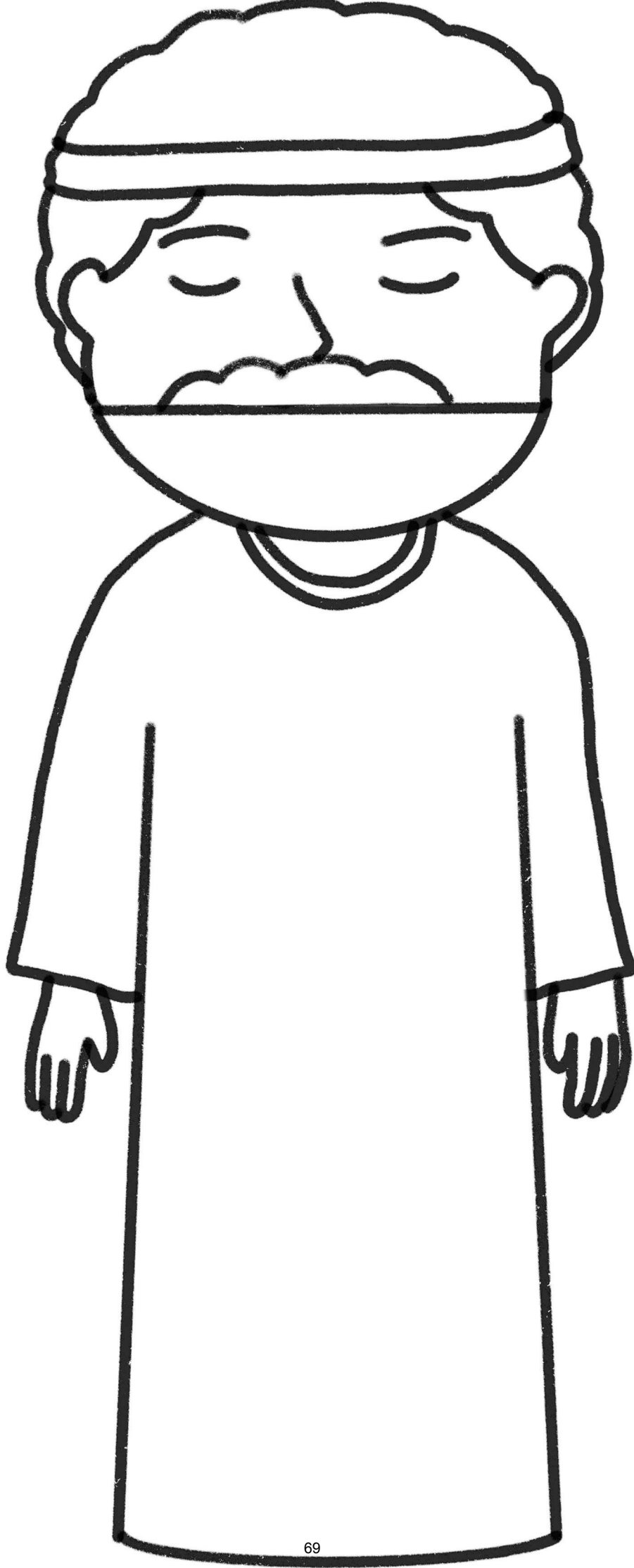

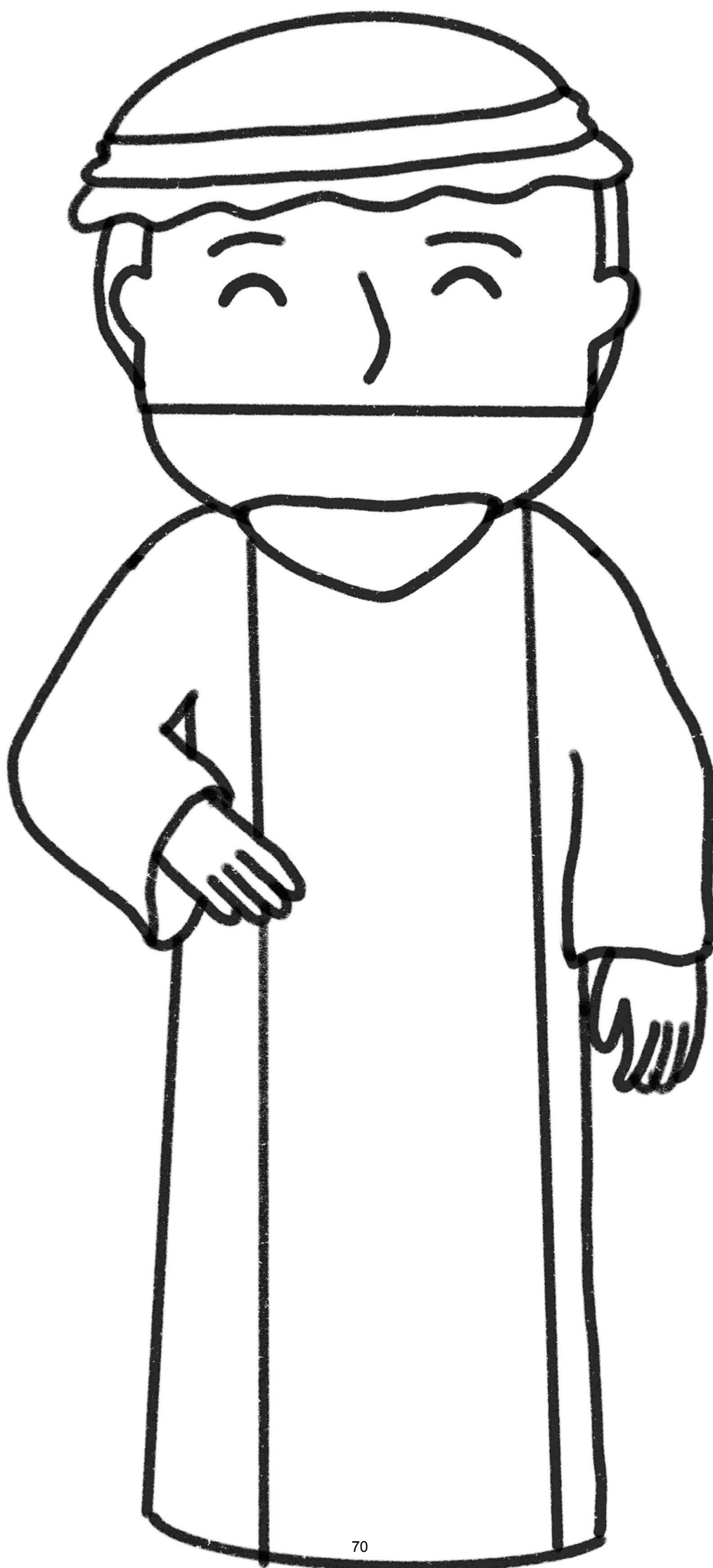

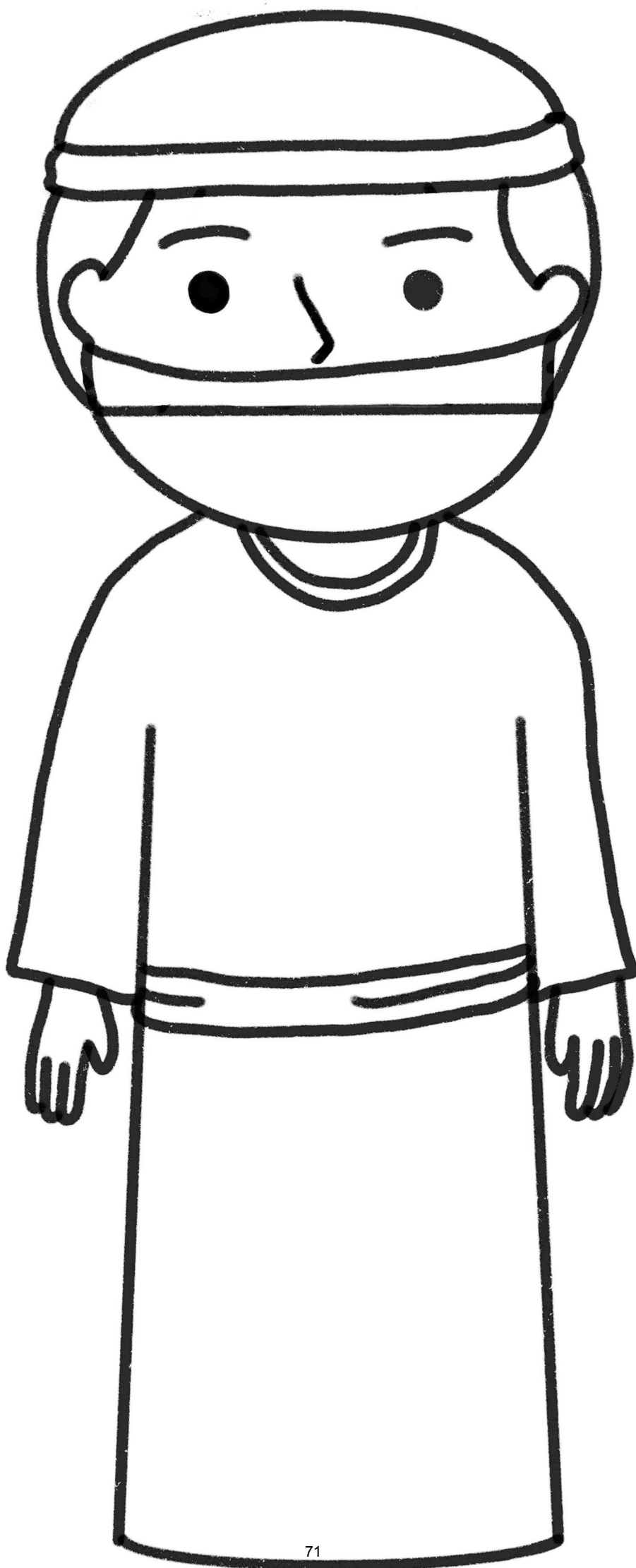

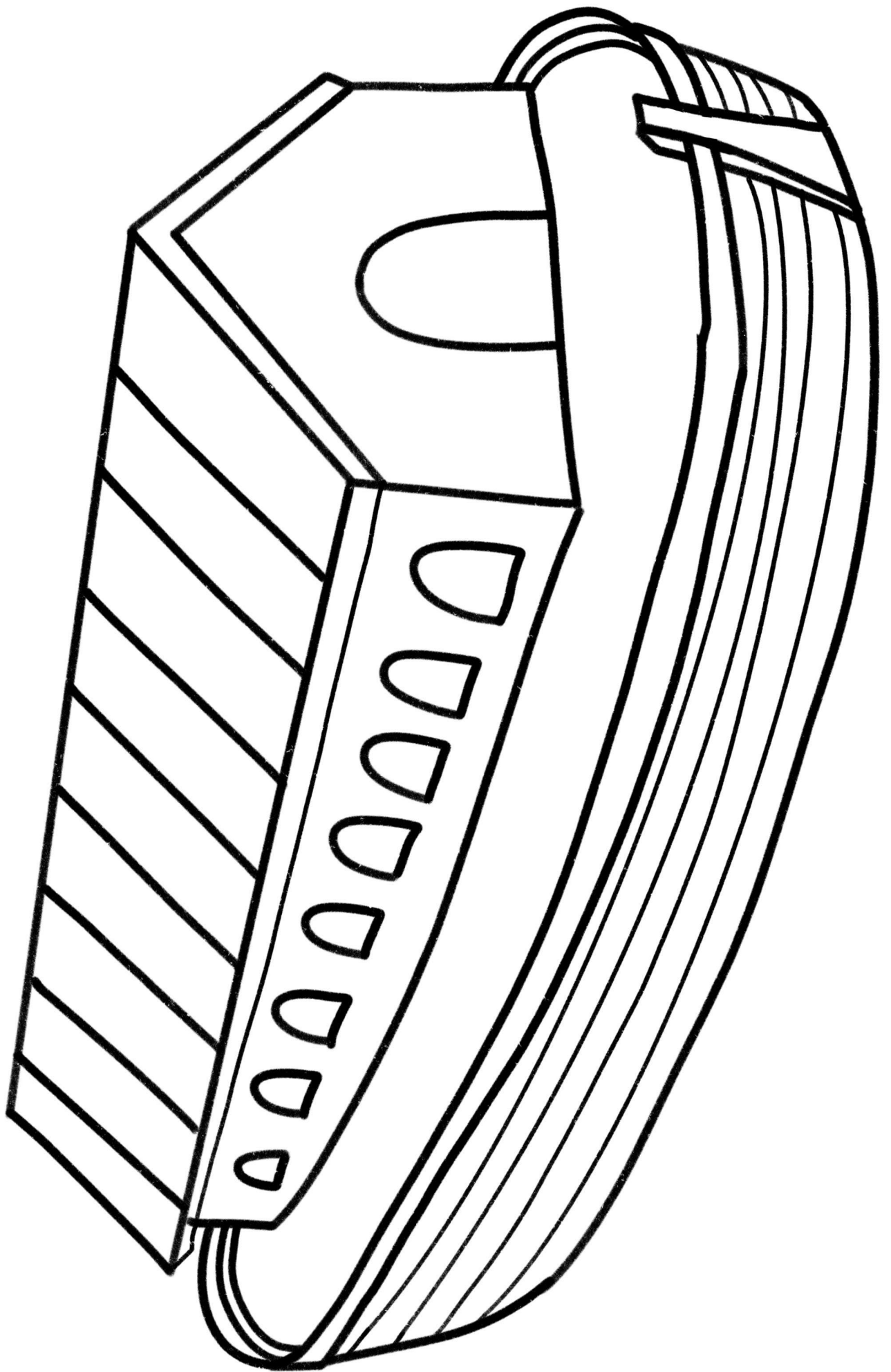

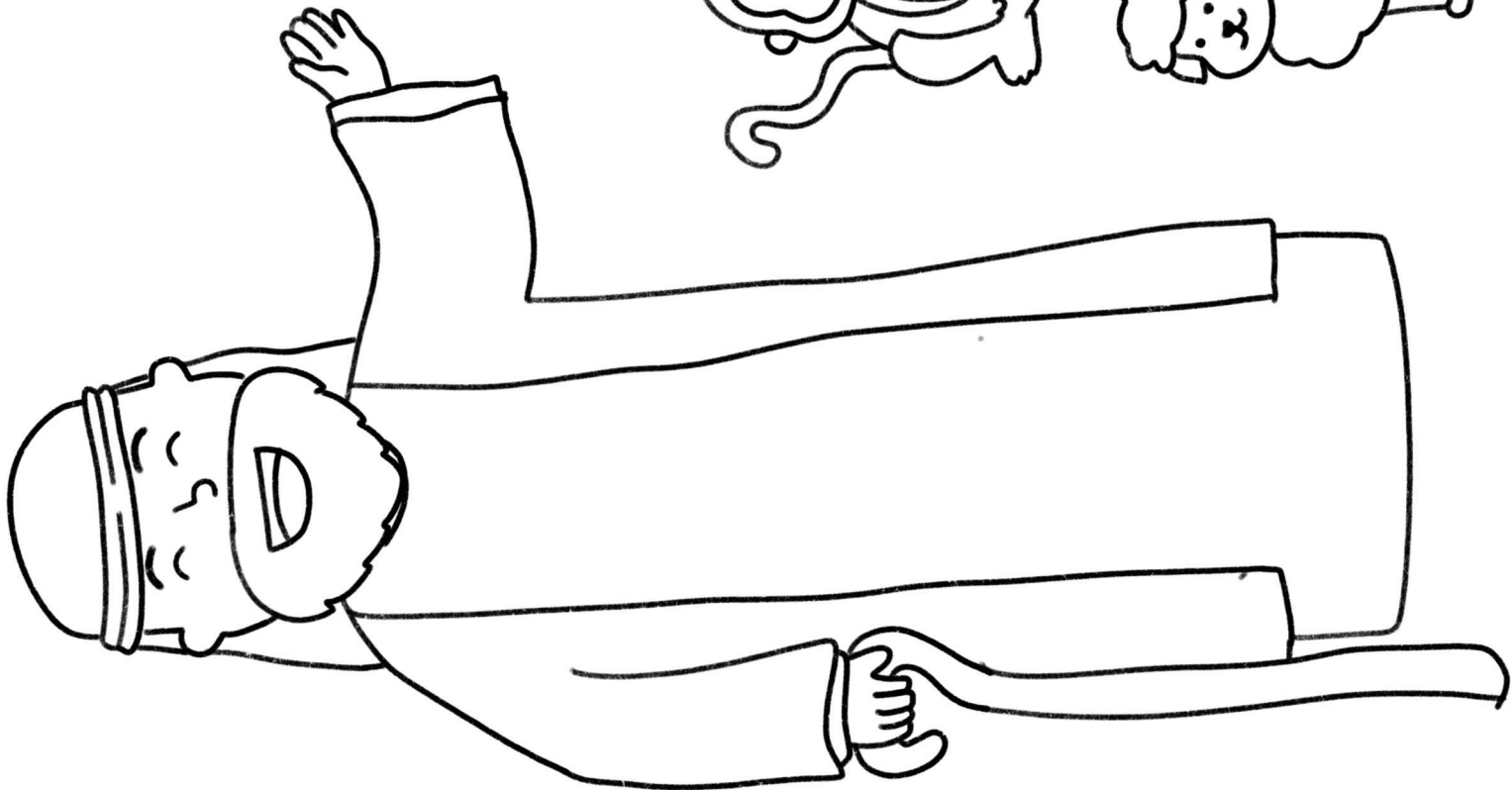

6-1 NOAH

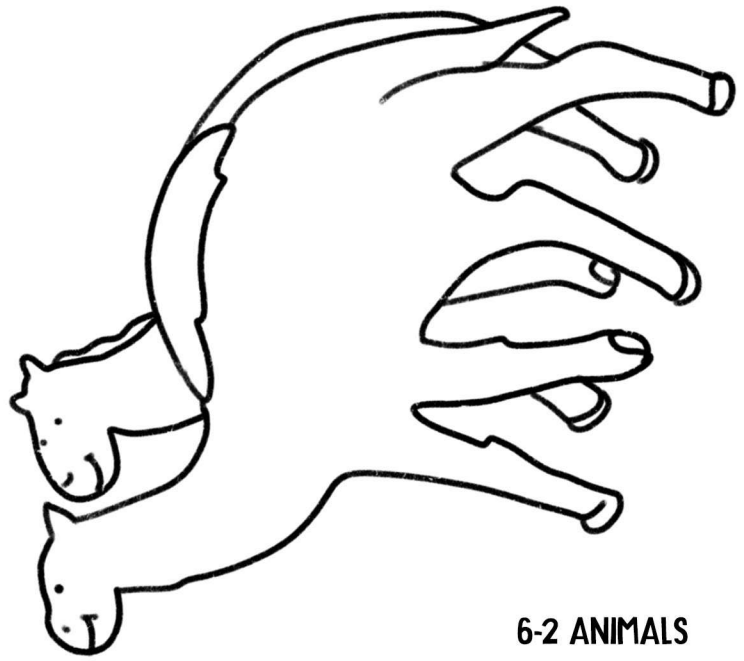

6-2 ANIMALS

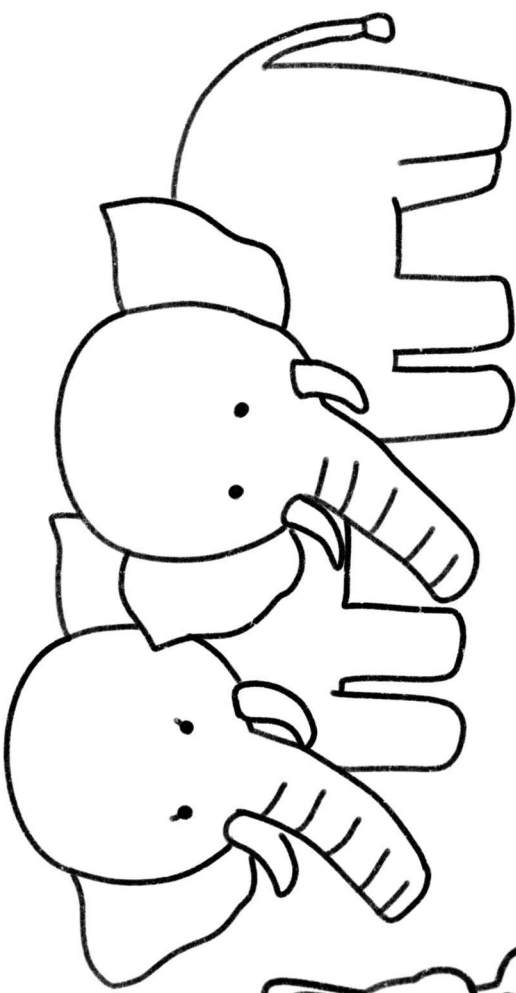
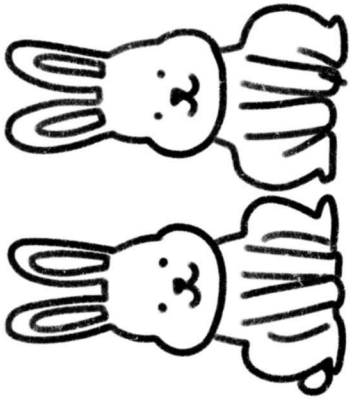
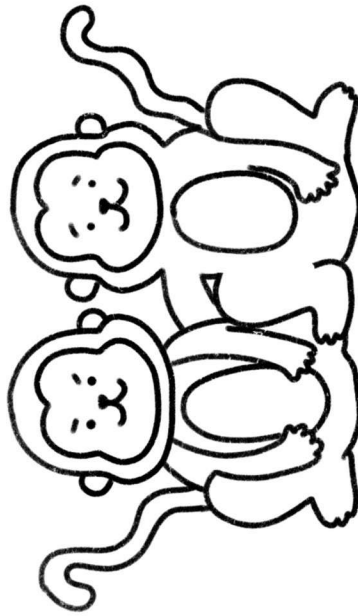

6-3 RAINBOW

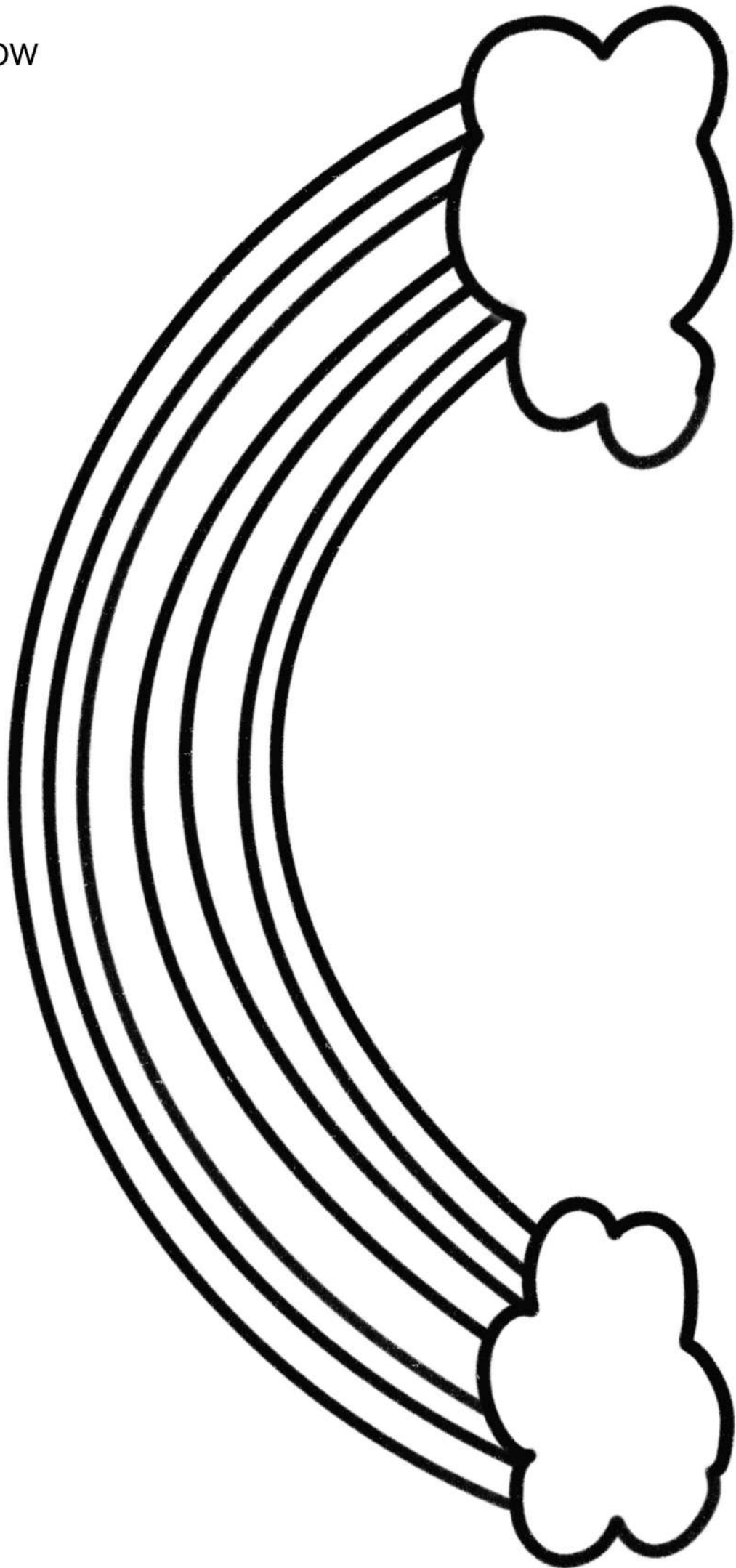

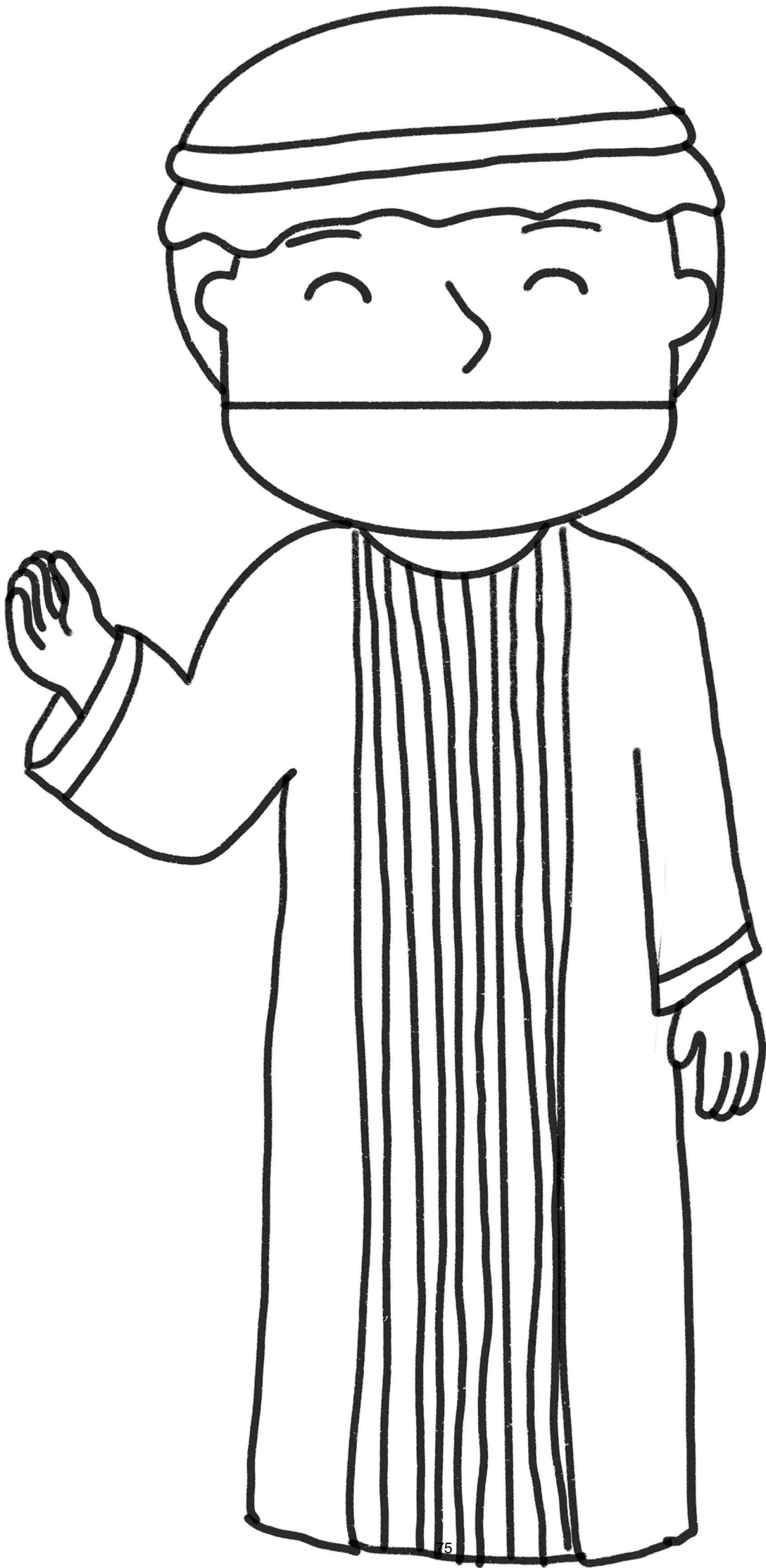





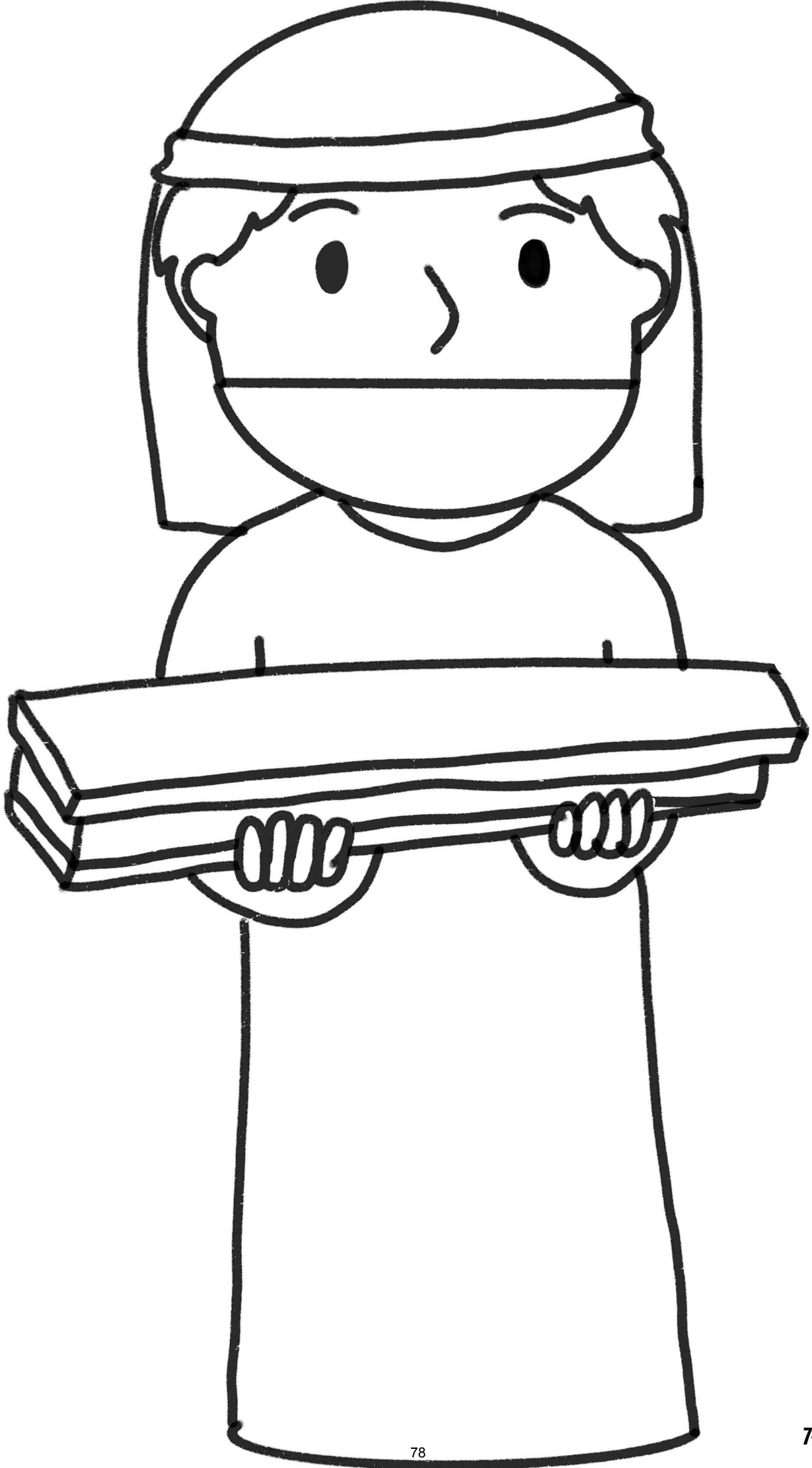



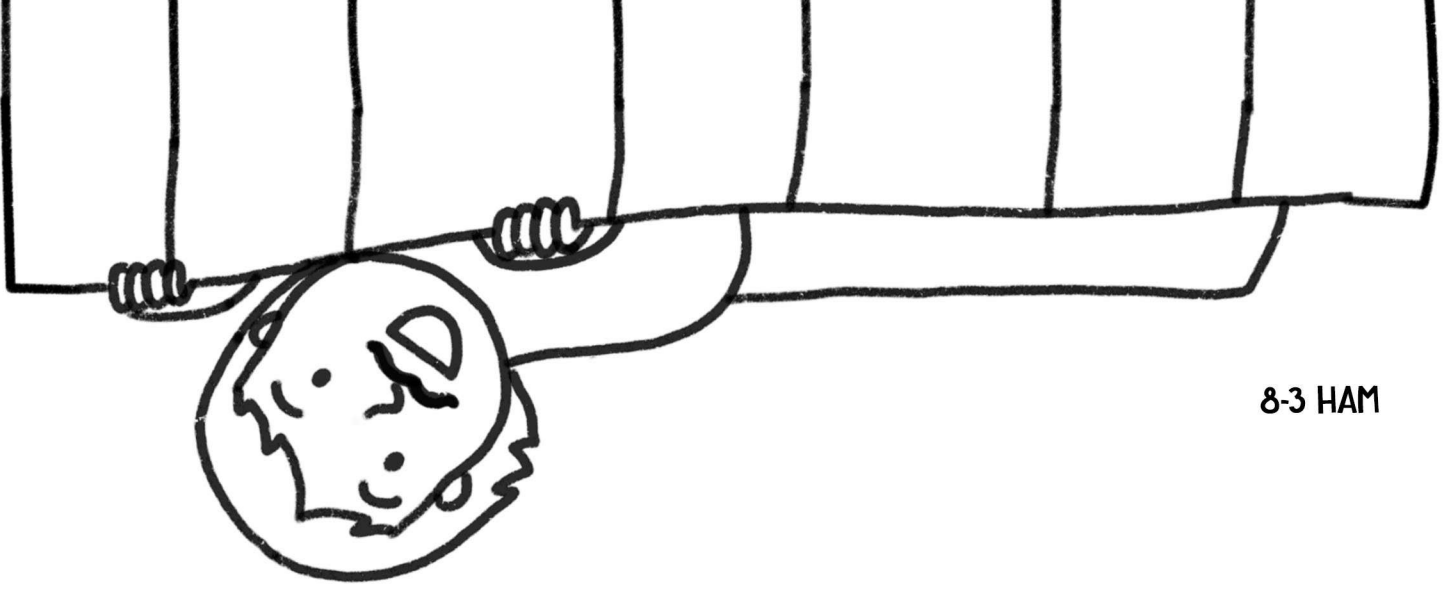

8-3 HAM



8-2 NOAH



8-1 TWO SON



8-5 LEAVING



8-4 BLESSING

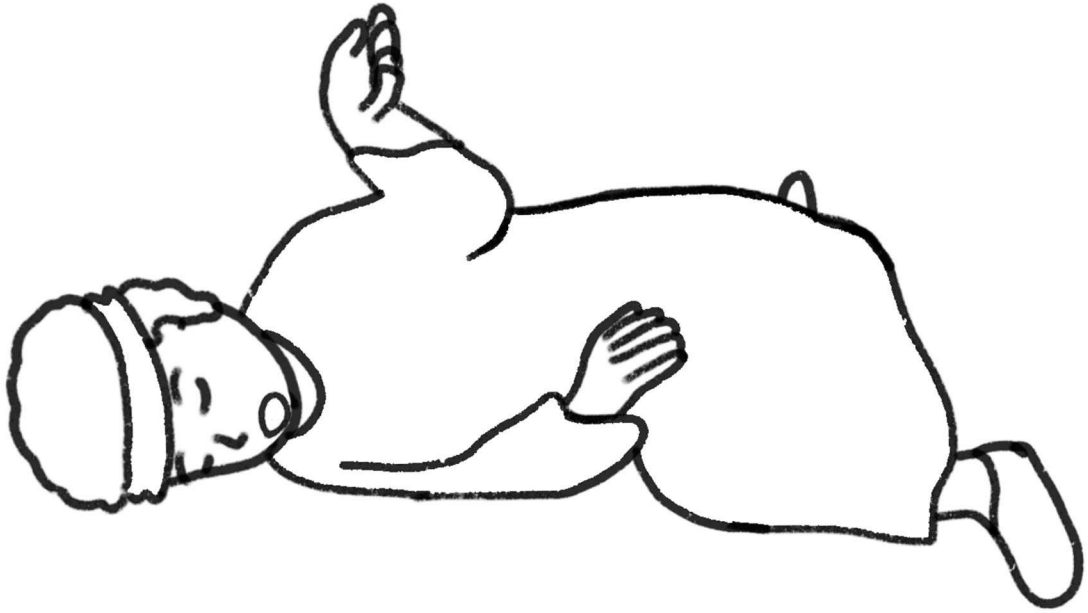

8-7

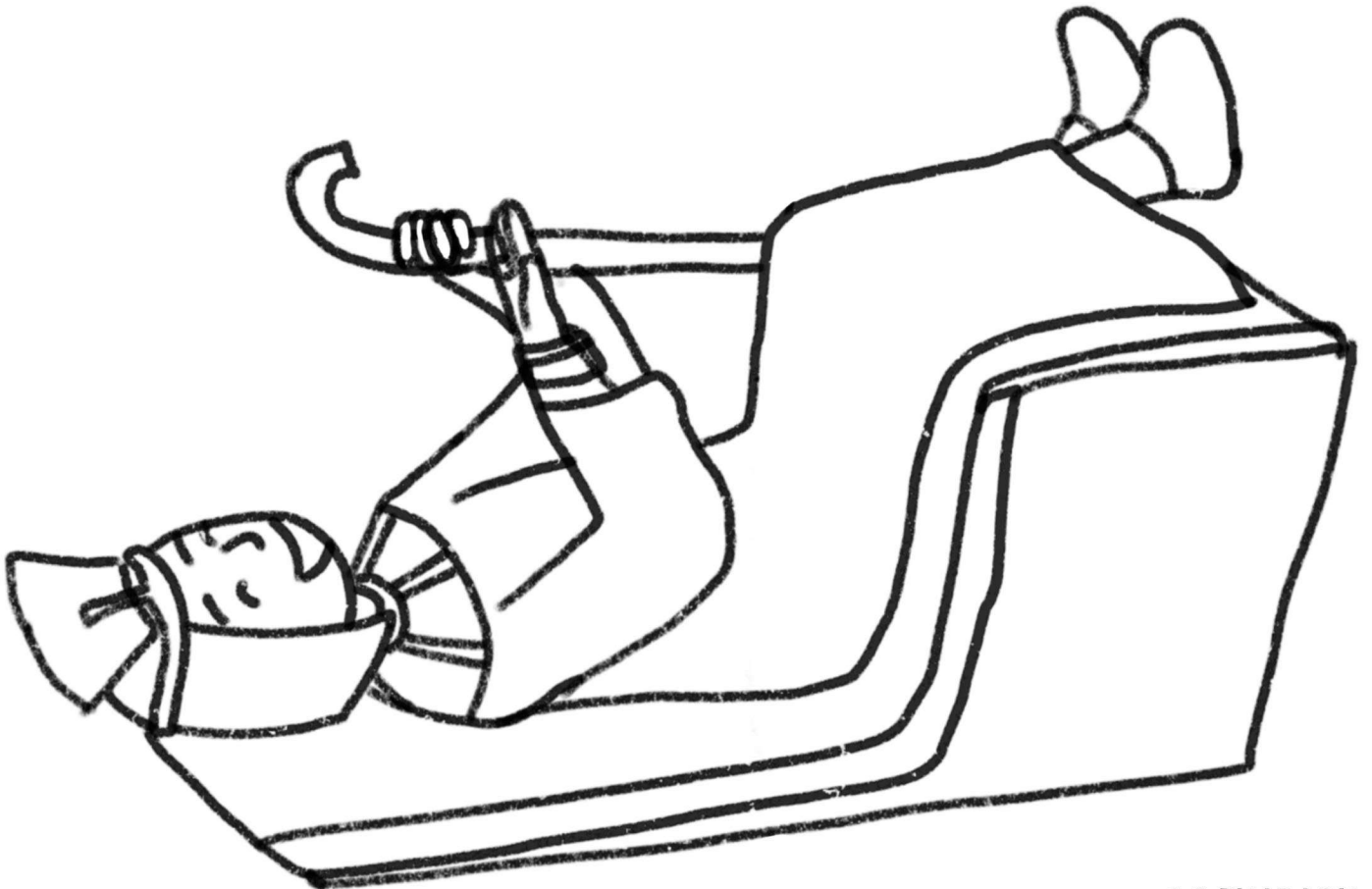

8-6 PHARAOH

8-8 MAD PHARAOH

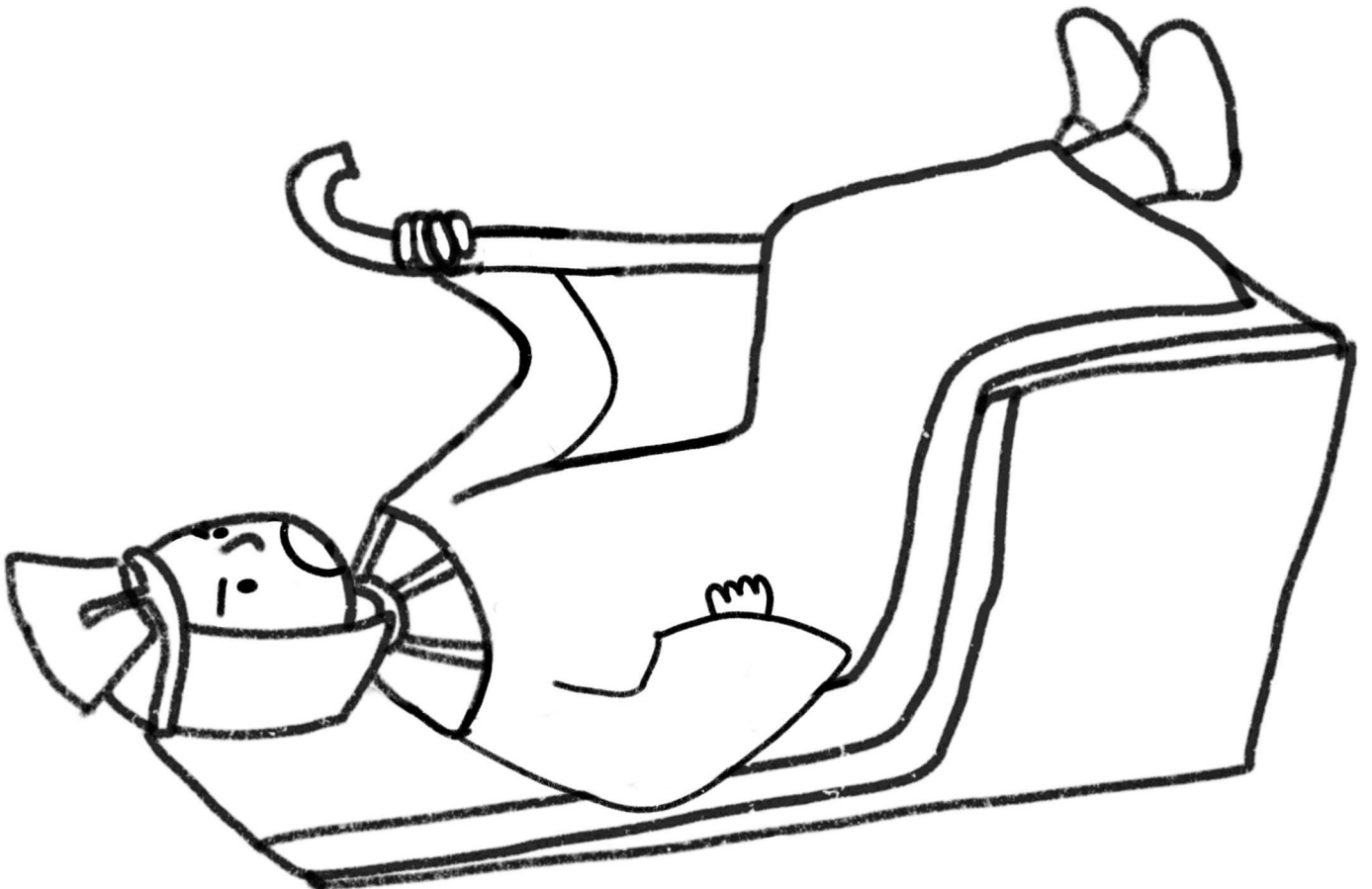

9-1 HAND OF GOD 1

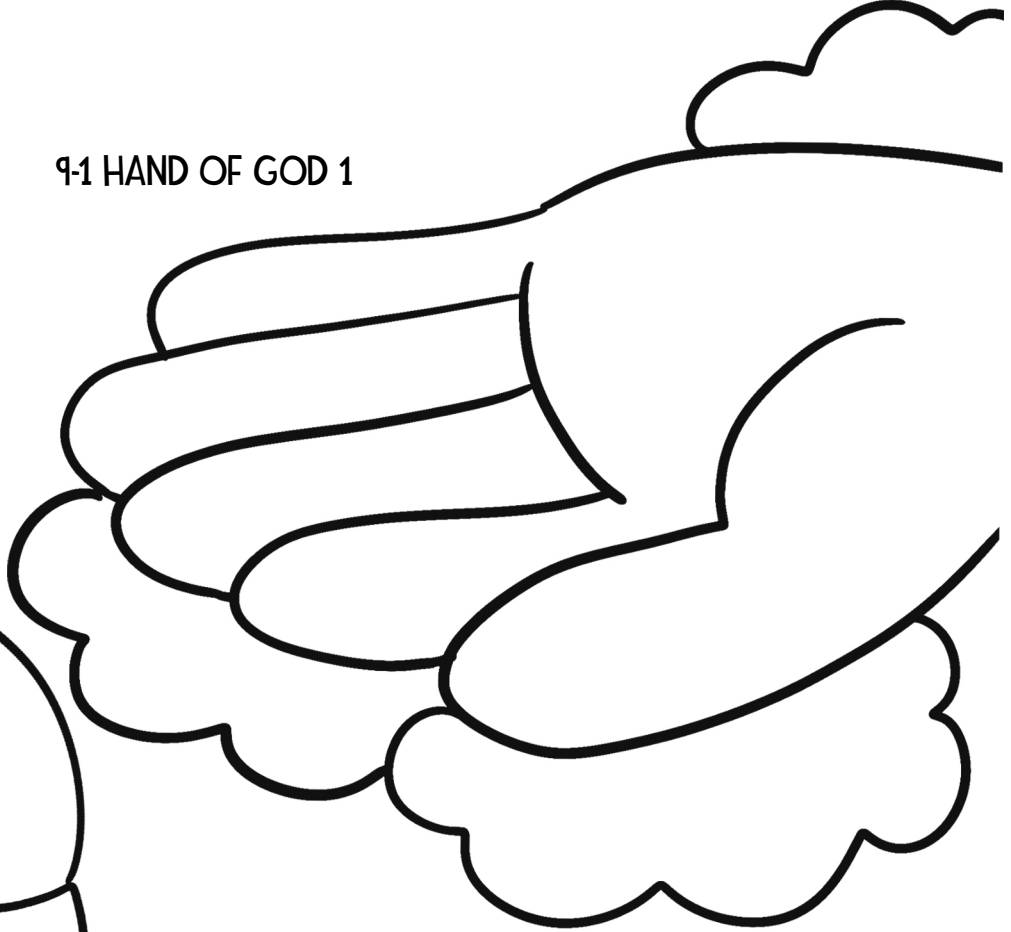

9-2 ABRAHAM

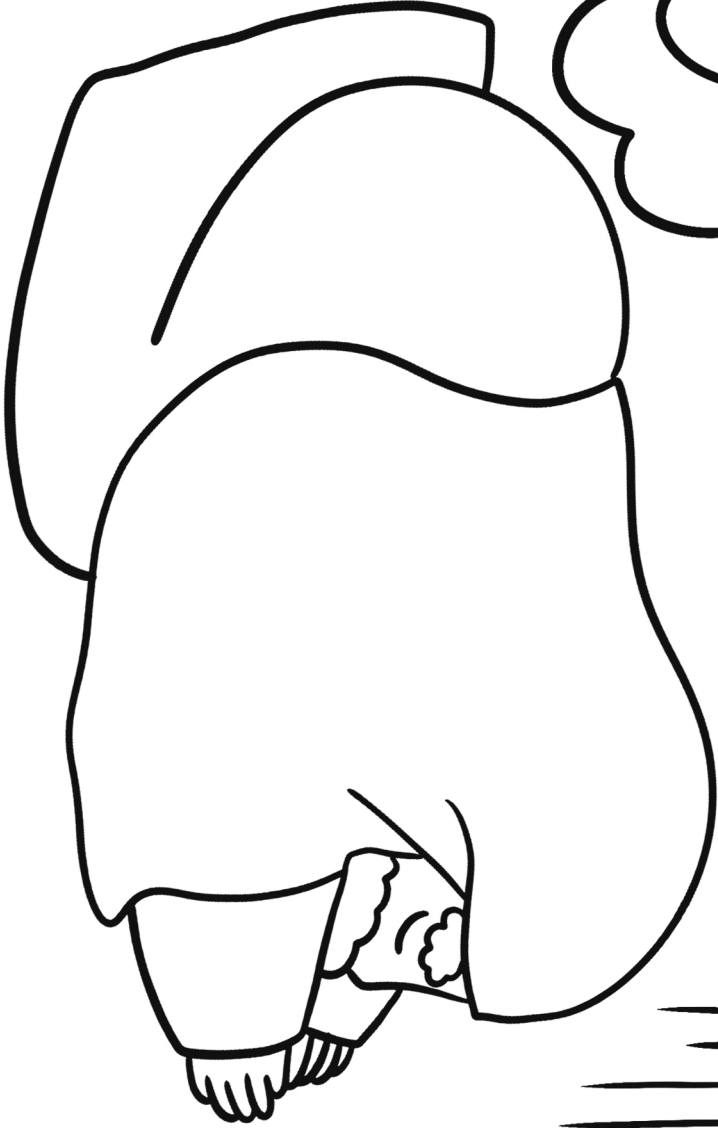

9-1 HAND OF GOD 2



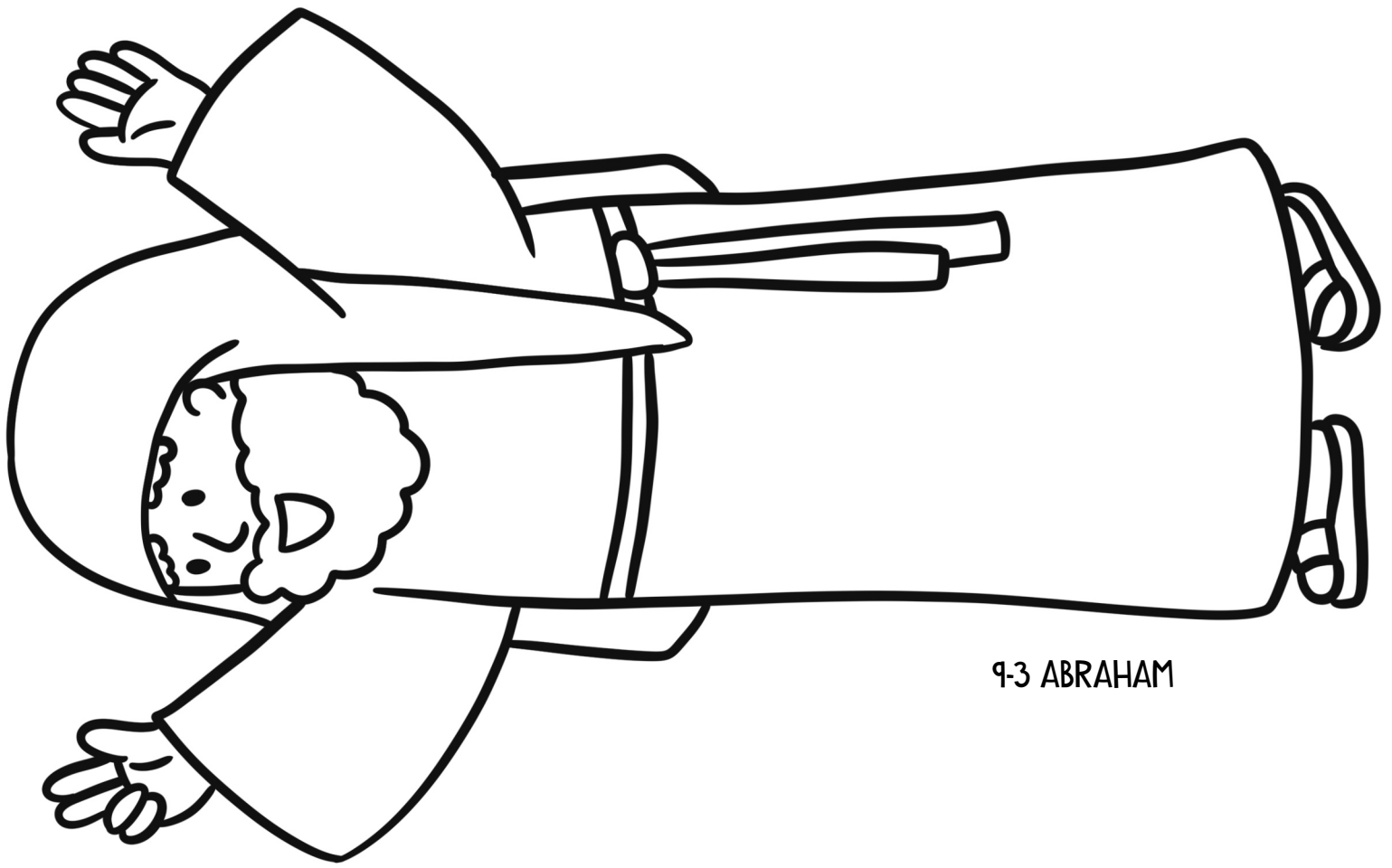

9-3 ABRAHAM

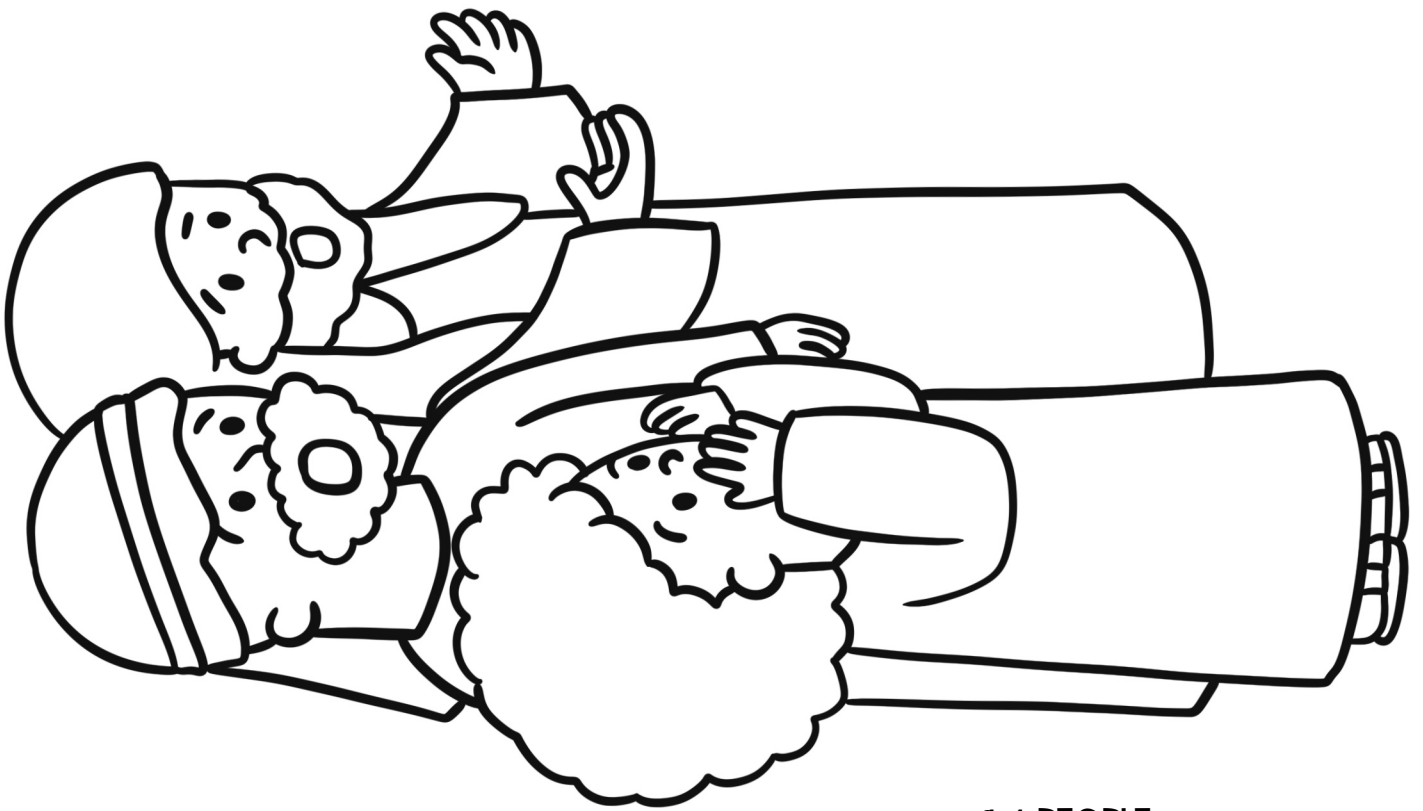

9-4 PEOPLE

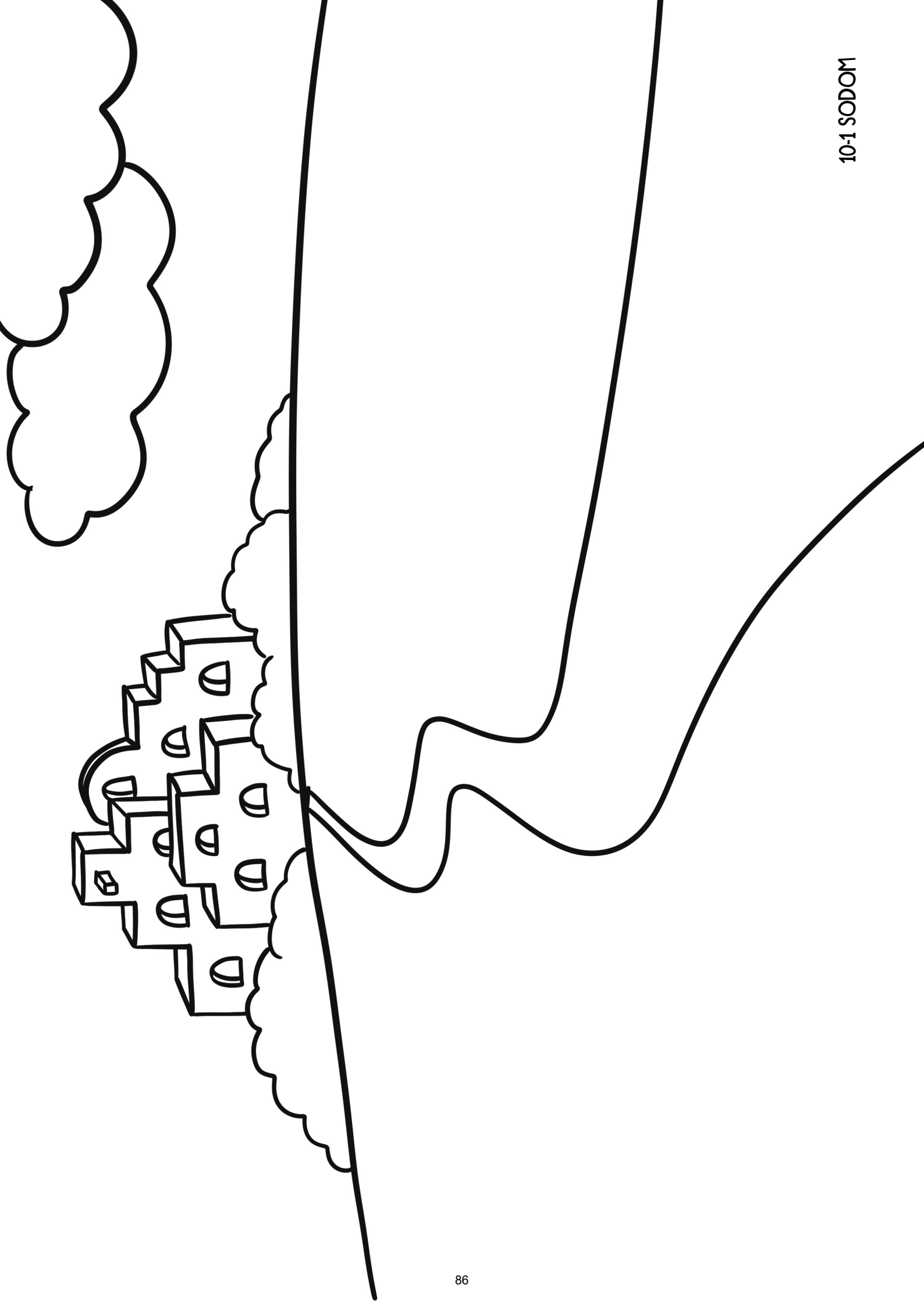

10-1 SODOM

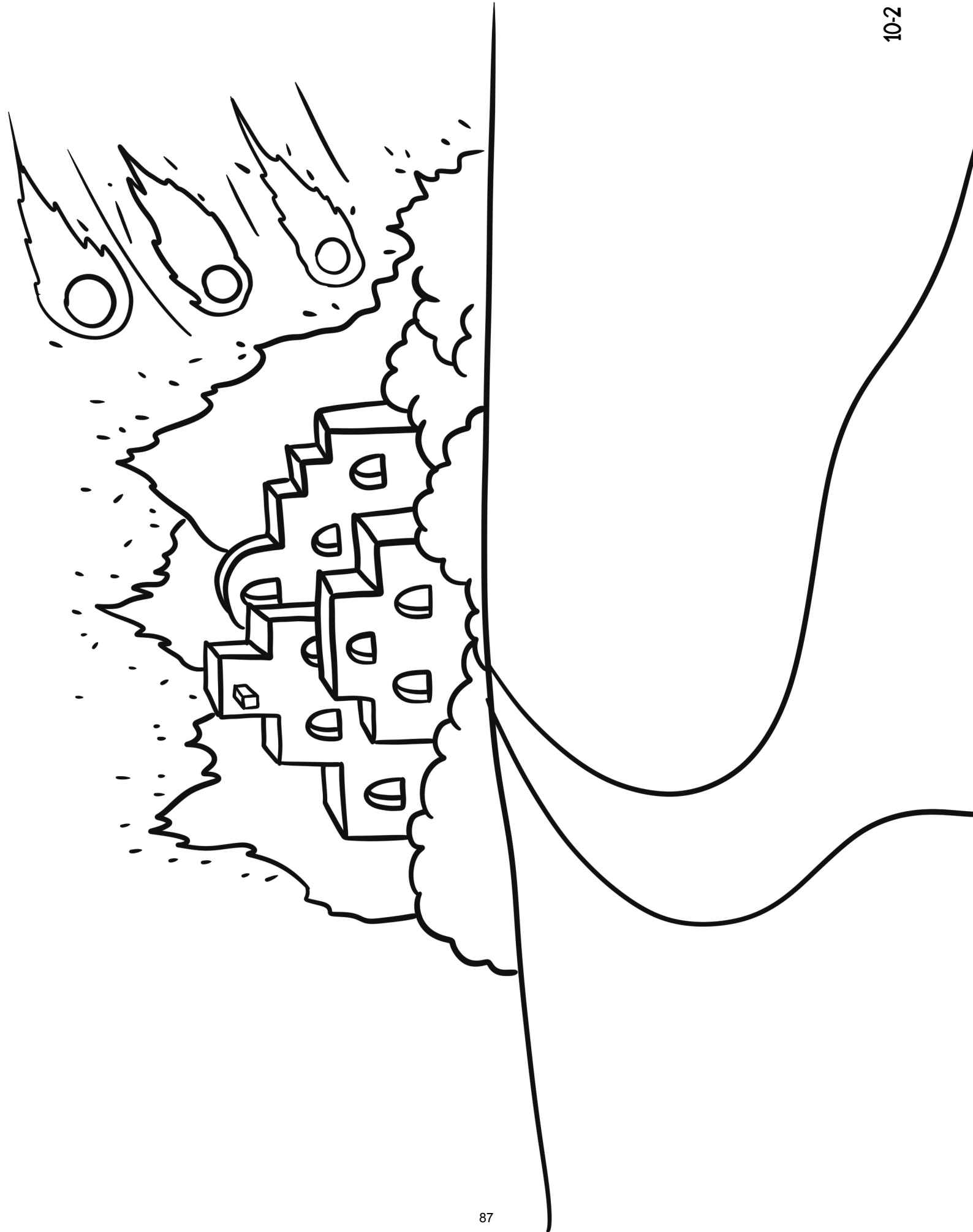

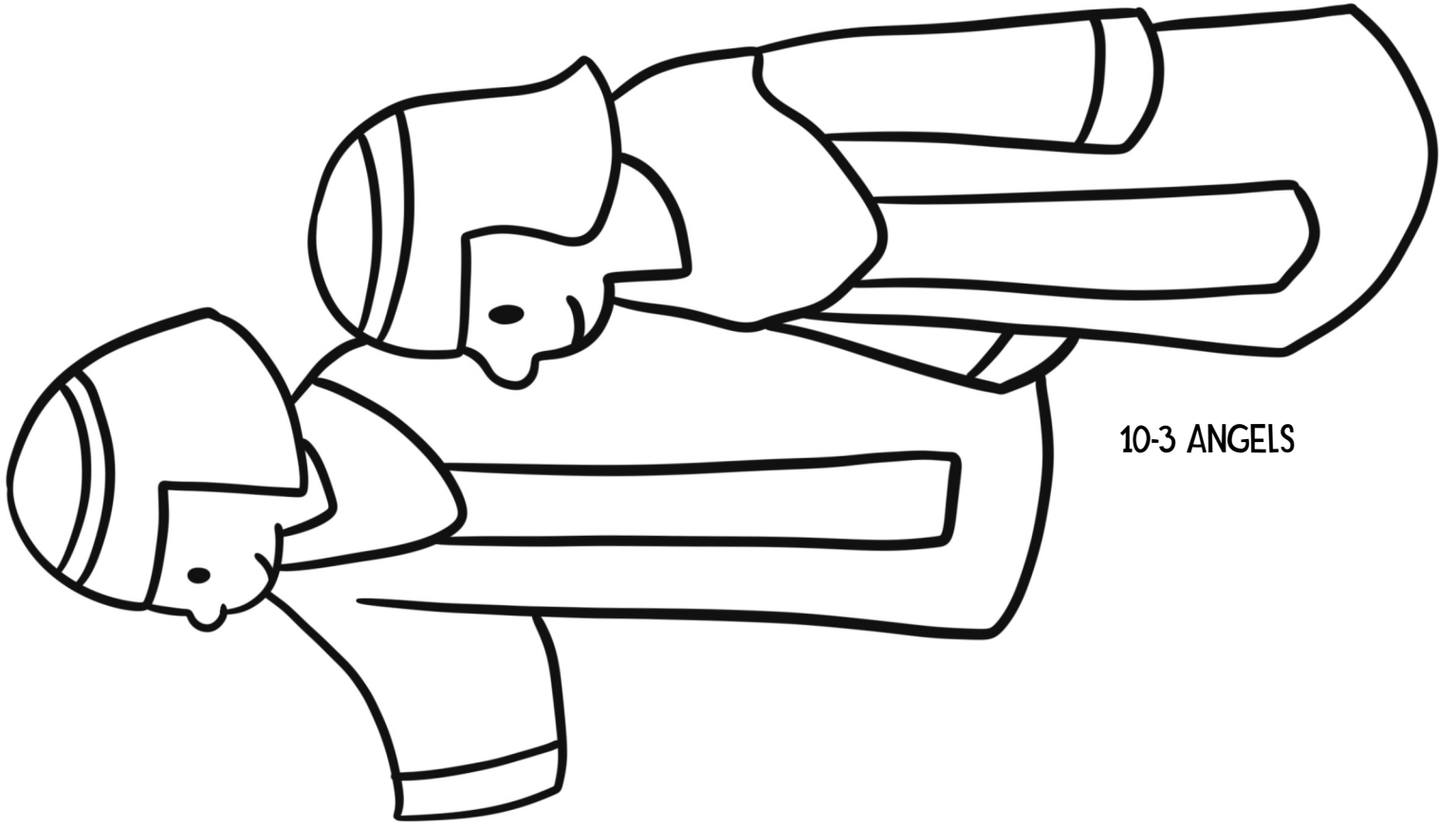

10-3 ANGELS



10-4 ABRAHAM

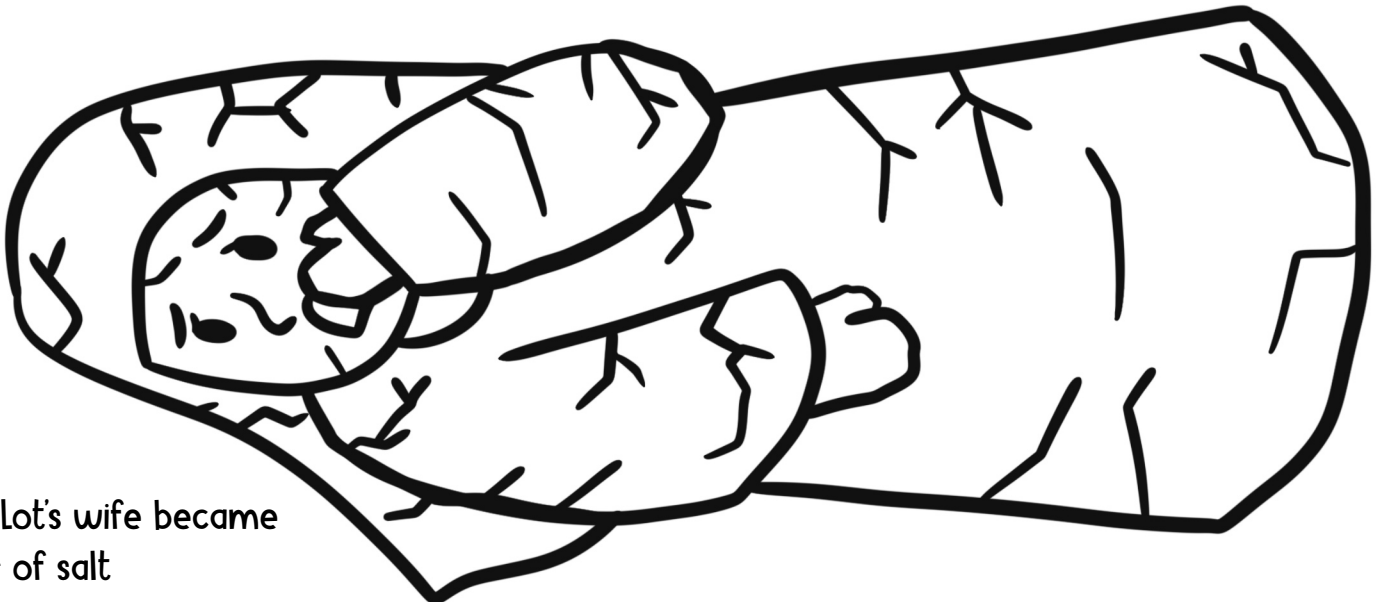

10-5 Lot's wife became pillar of salt

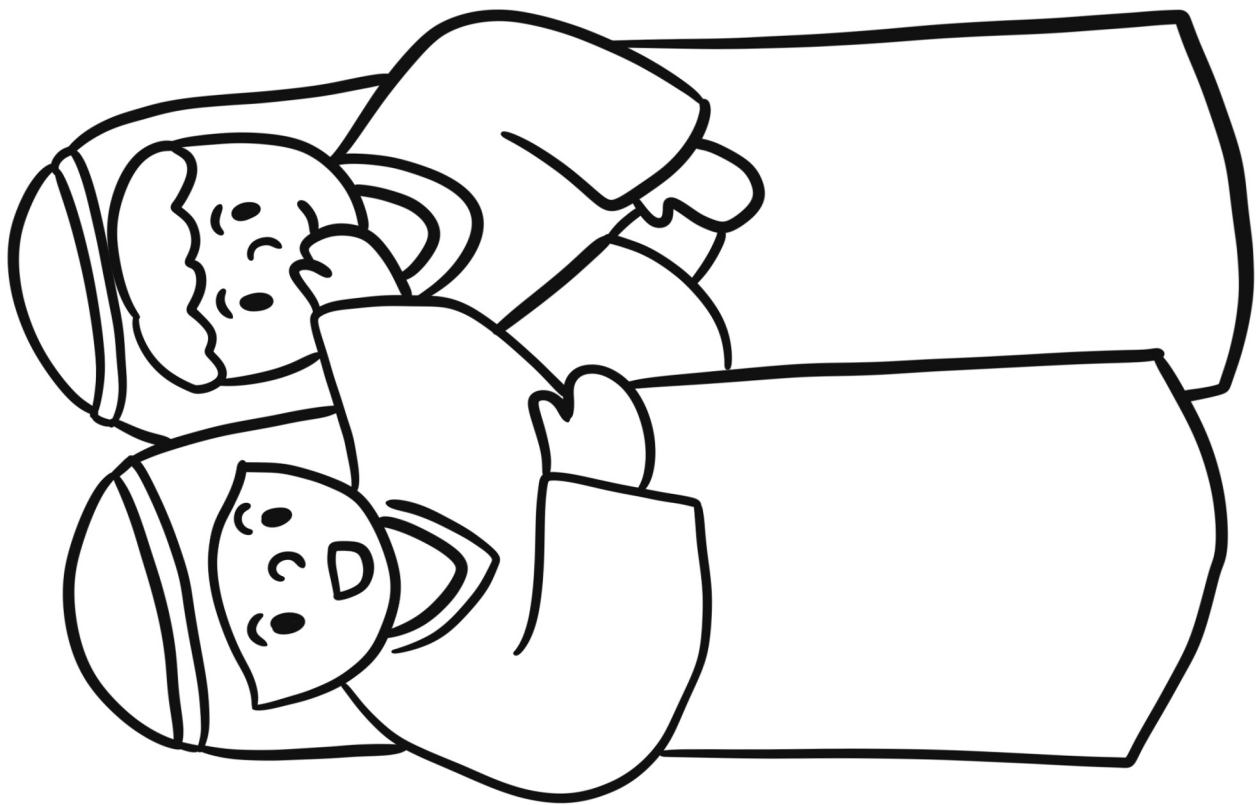

10-6 two daughters

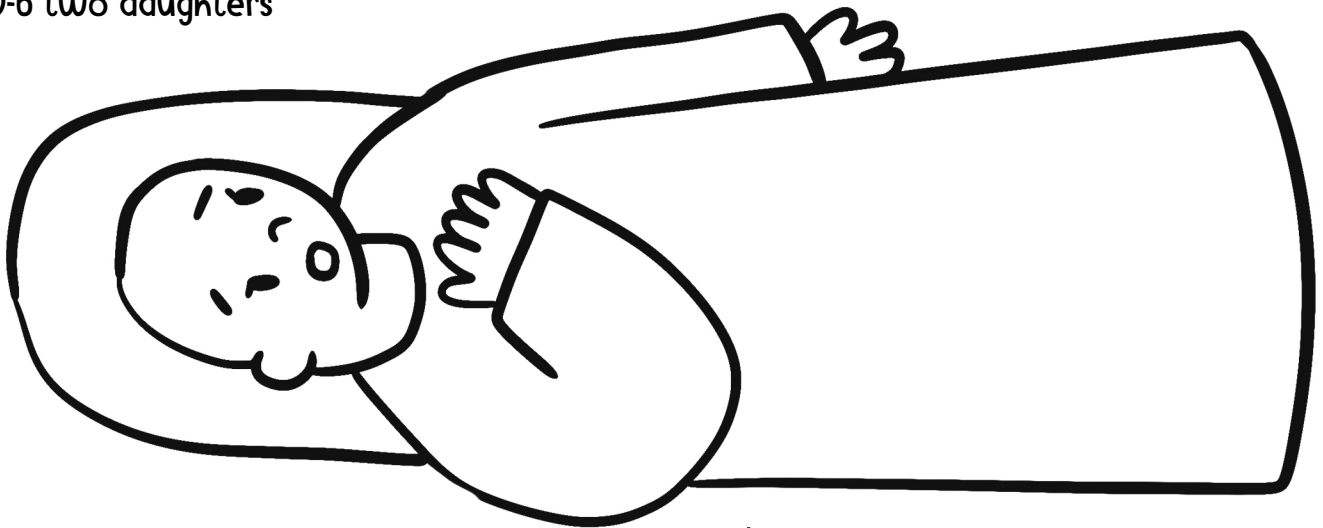

10-7 lot's wife

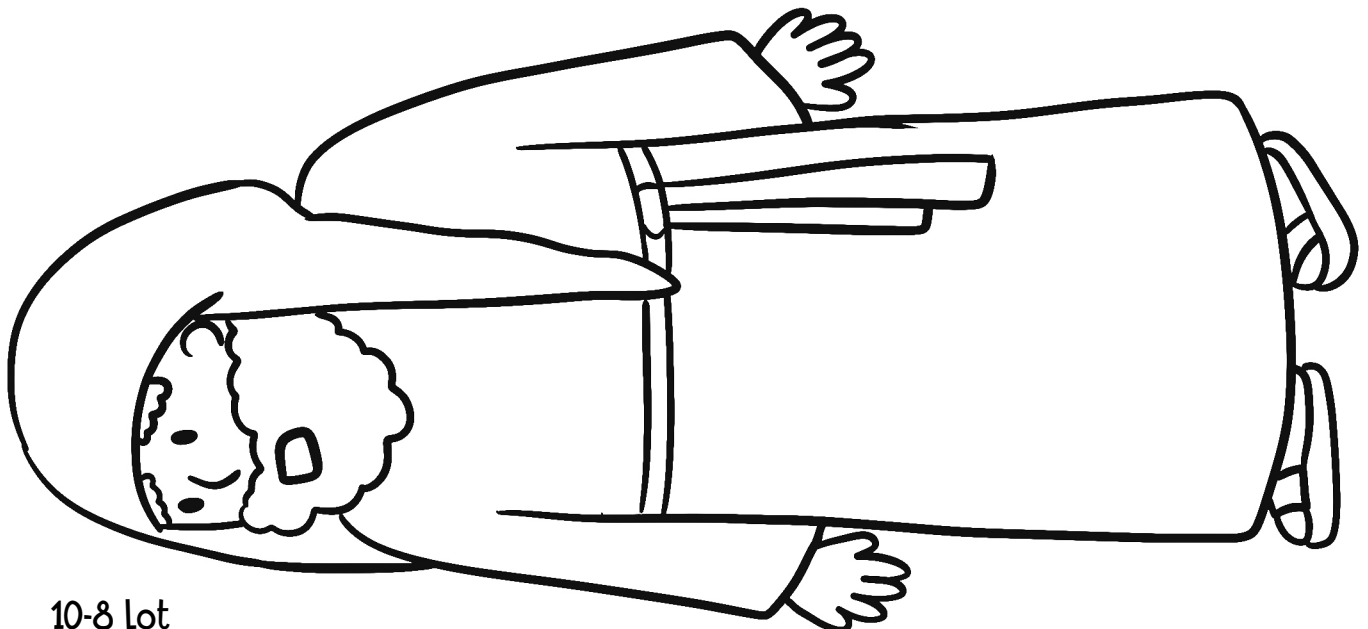

10-8 lot

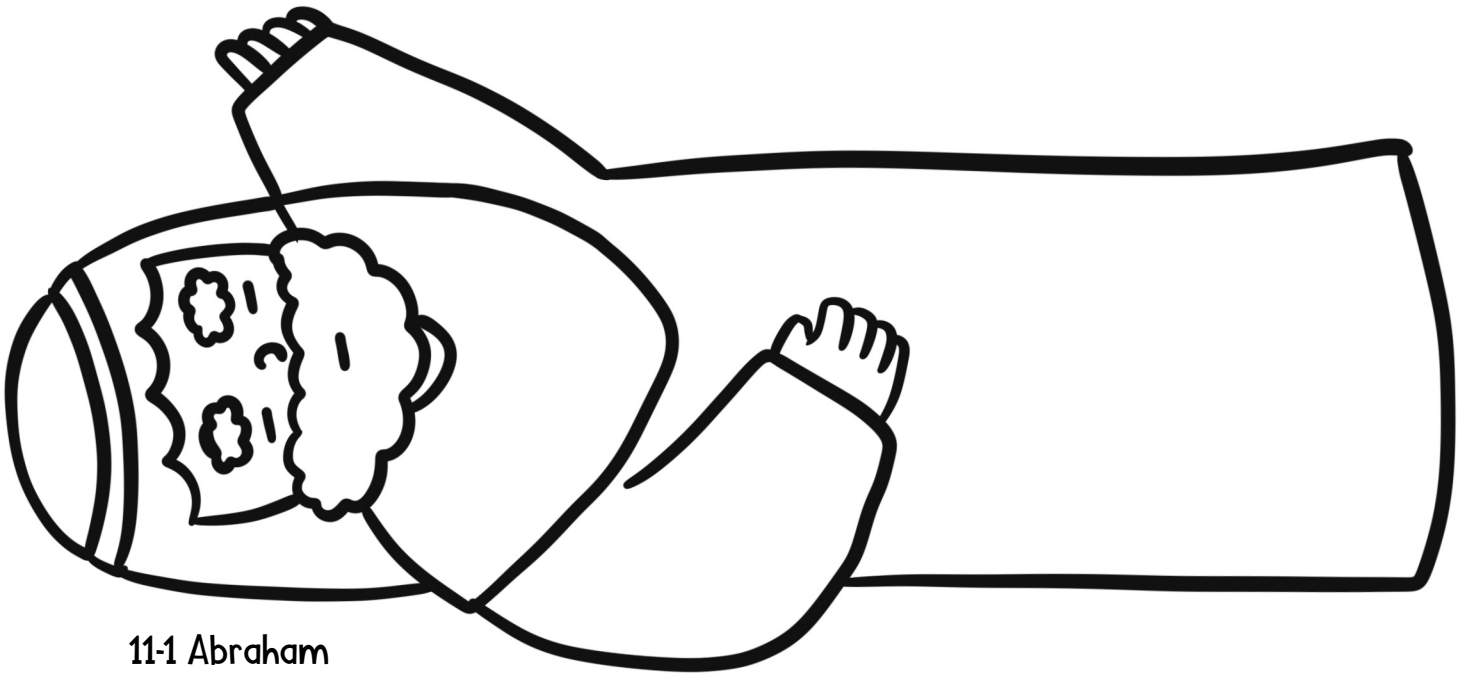

11-1 Abraham

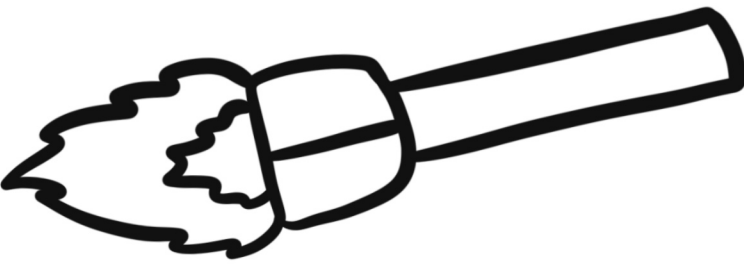

11-2 Fire



11-3 Knife

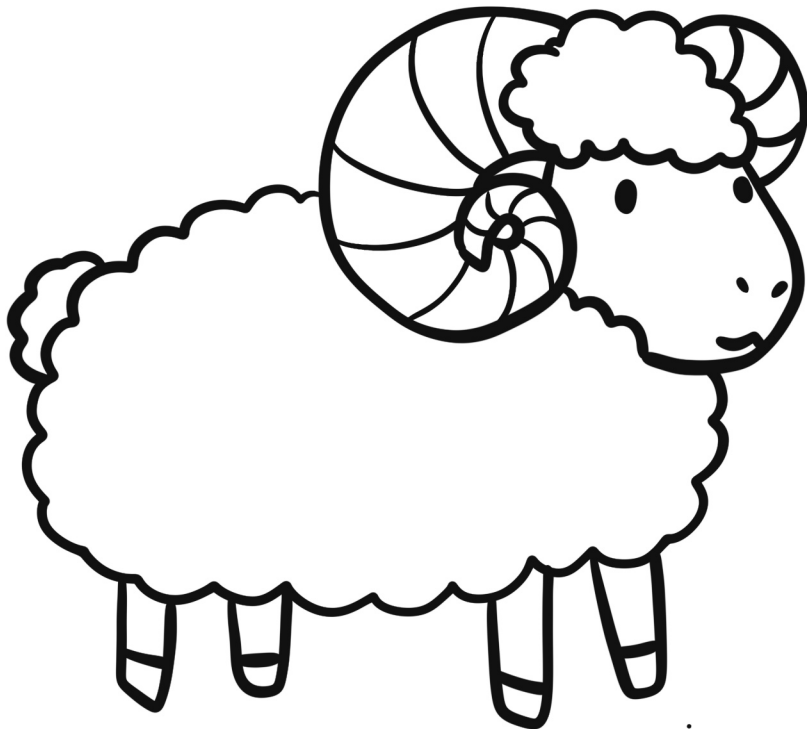

11-4 Ram



11-5 Sarah



11-6 Angels

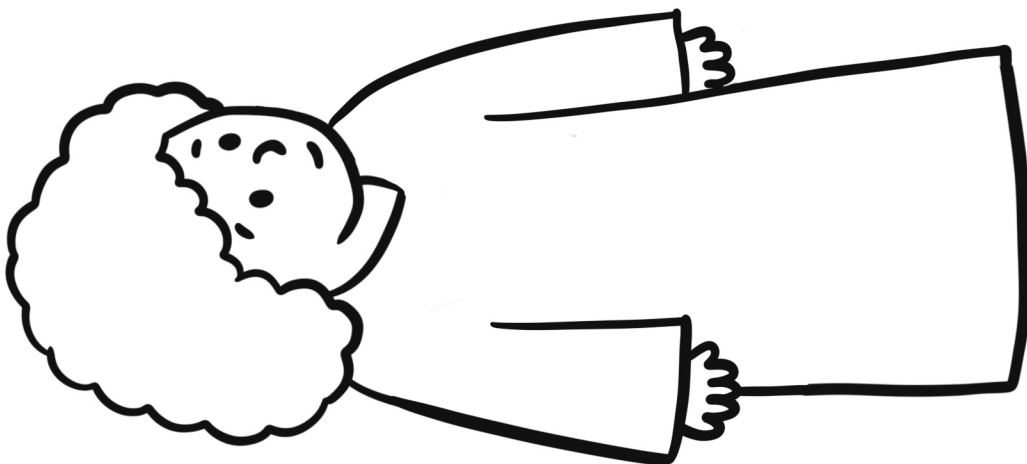

11-7 Isaac

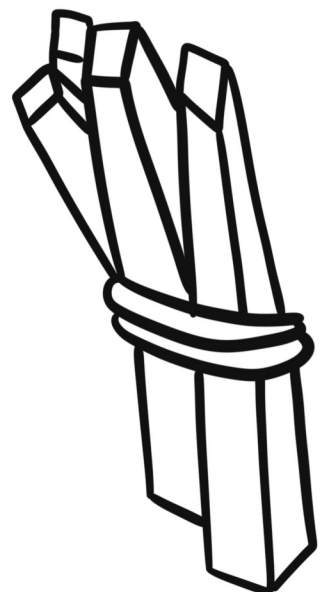

11-8 Woods

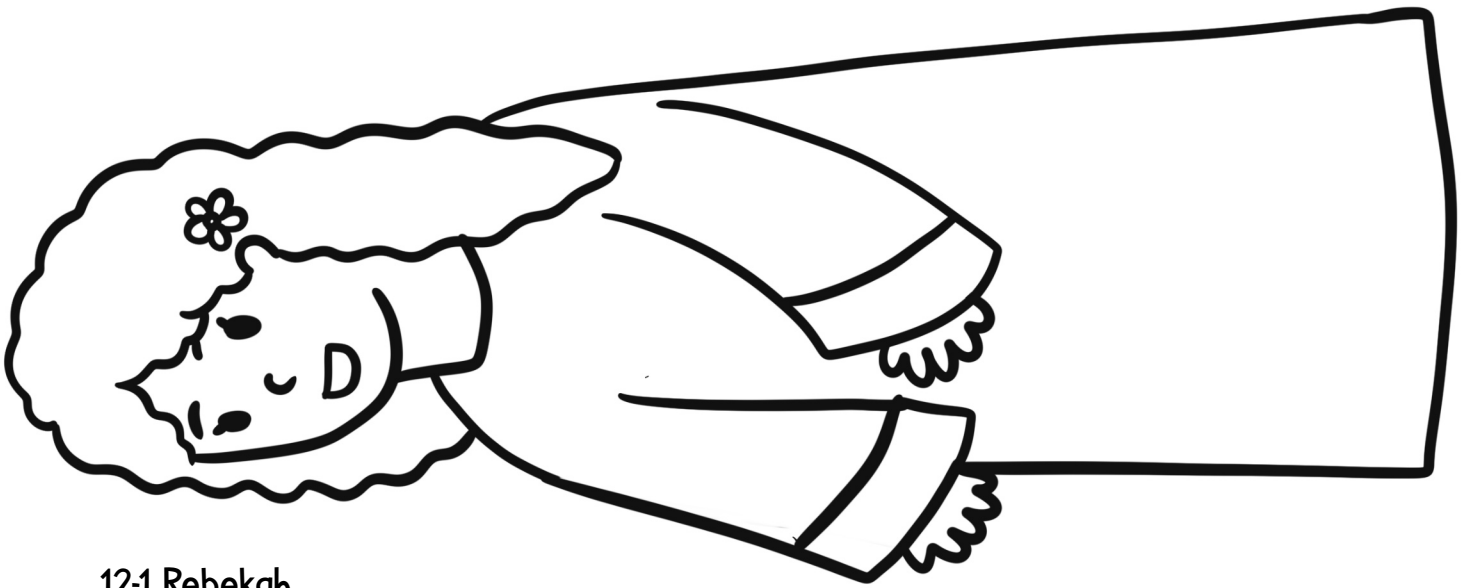

12-1 Rebekah

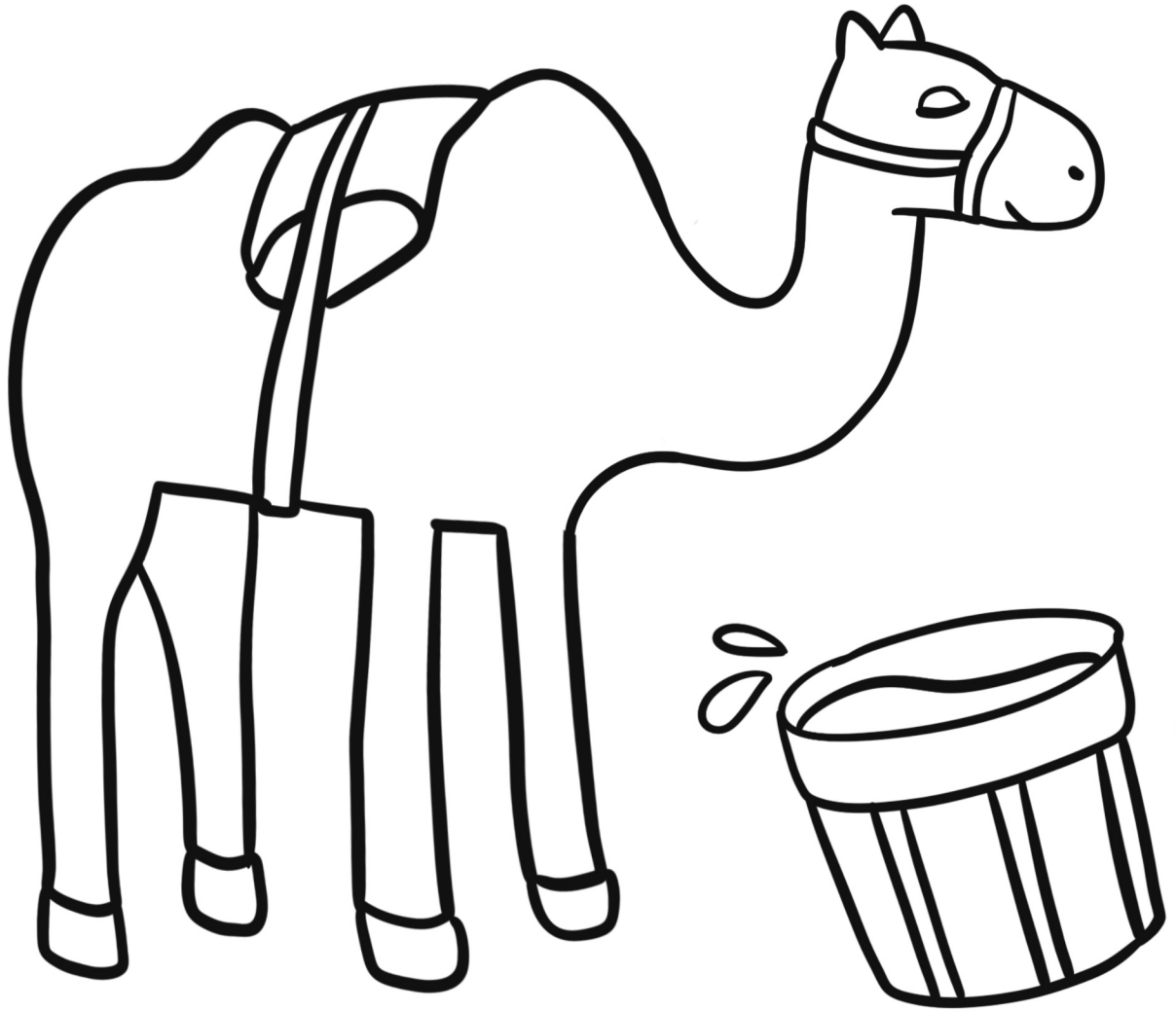

12-2 Camel

12-3 Water bucket

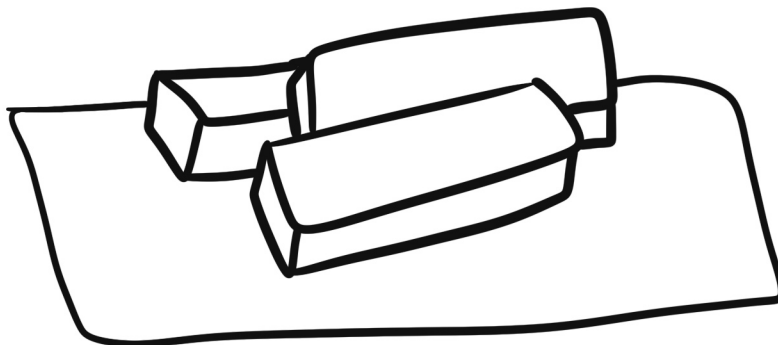

12-4 Gold

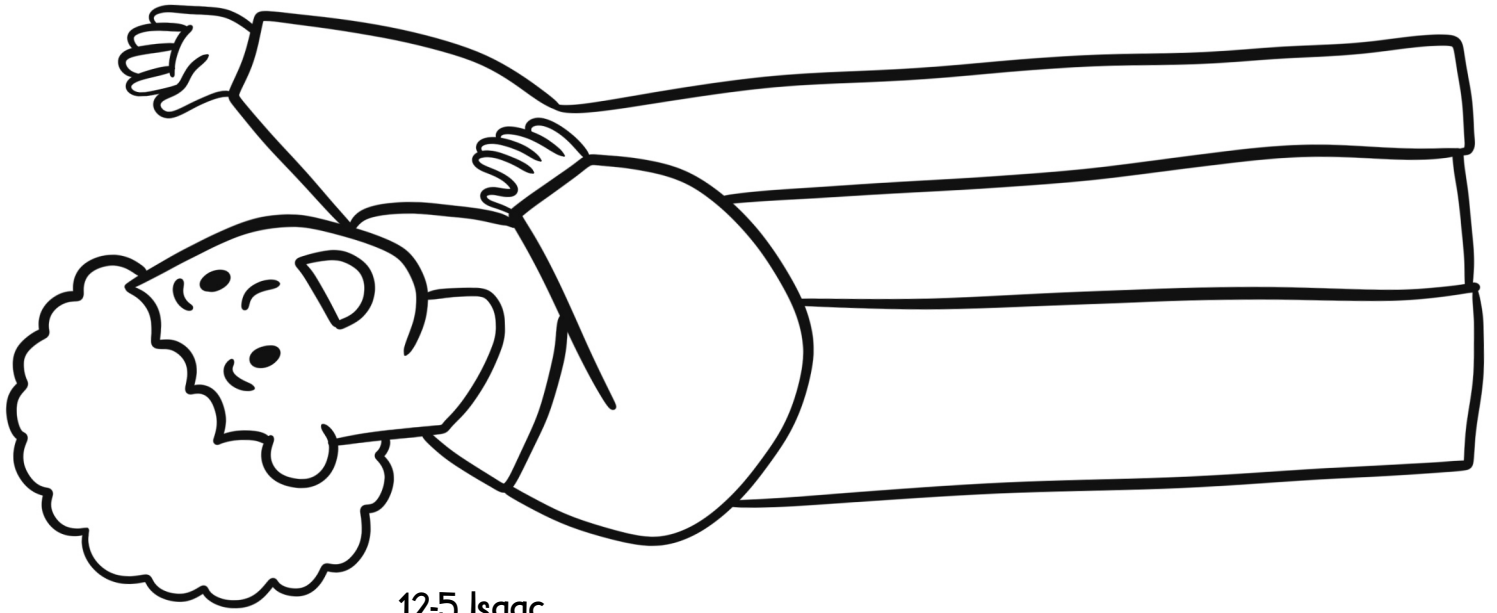

12-5 Isaac

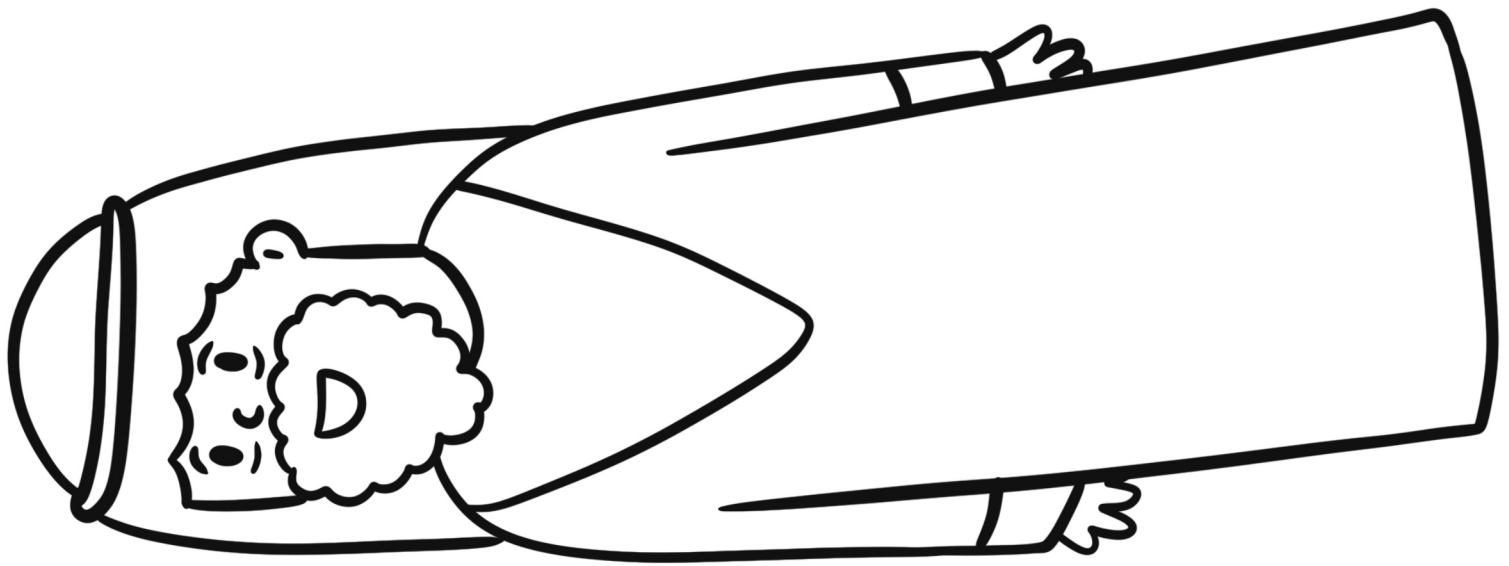

12-6 Servant

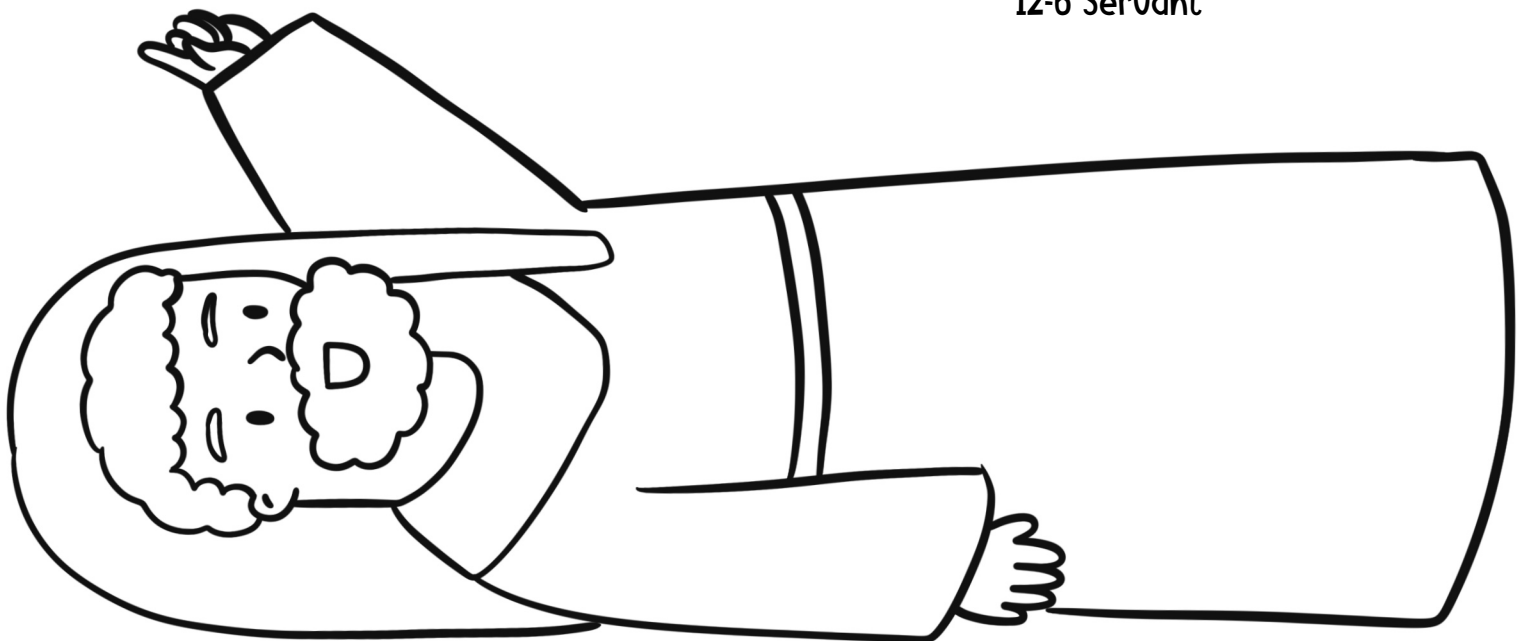

12-7 laban

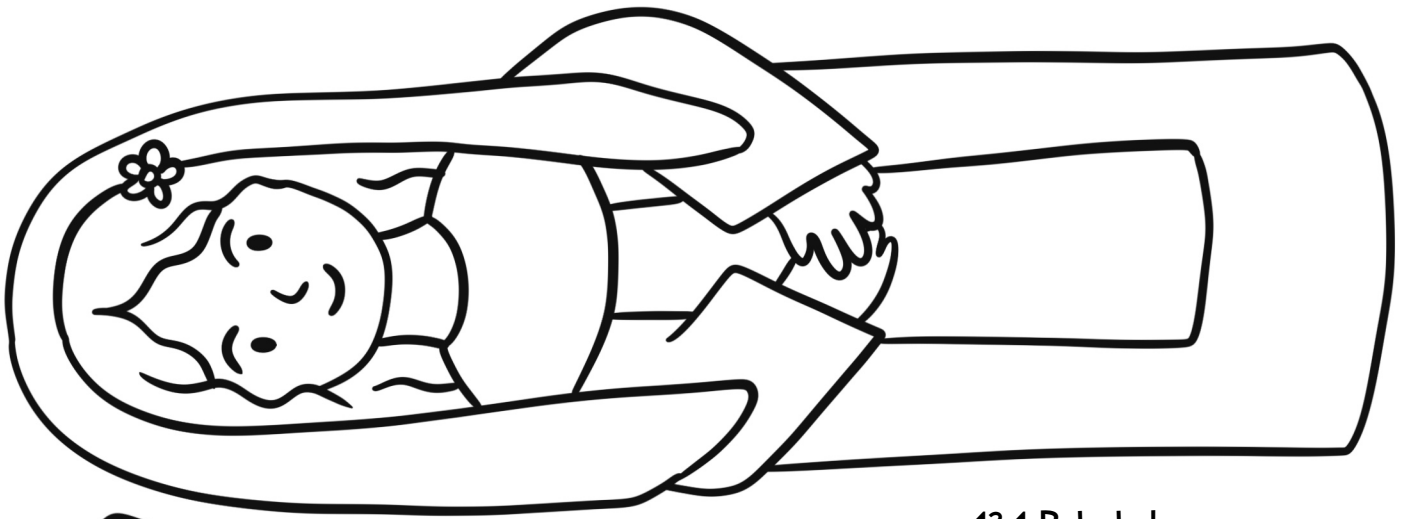

13-1 Rebekah

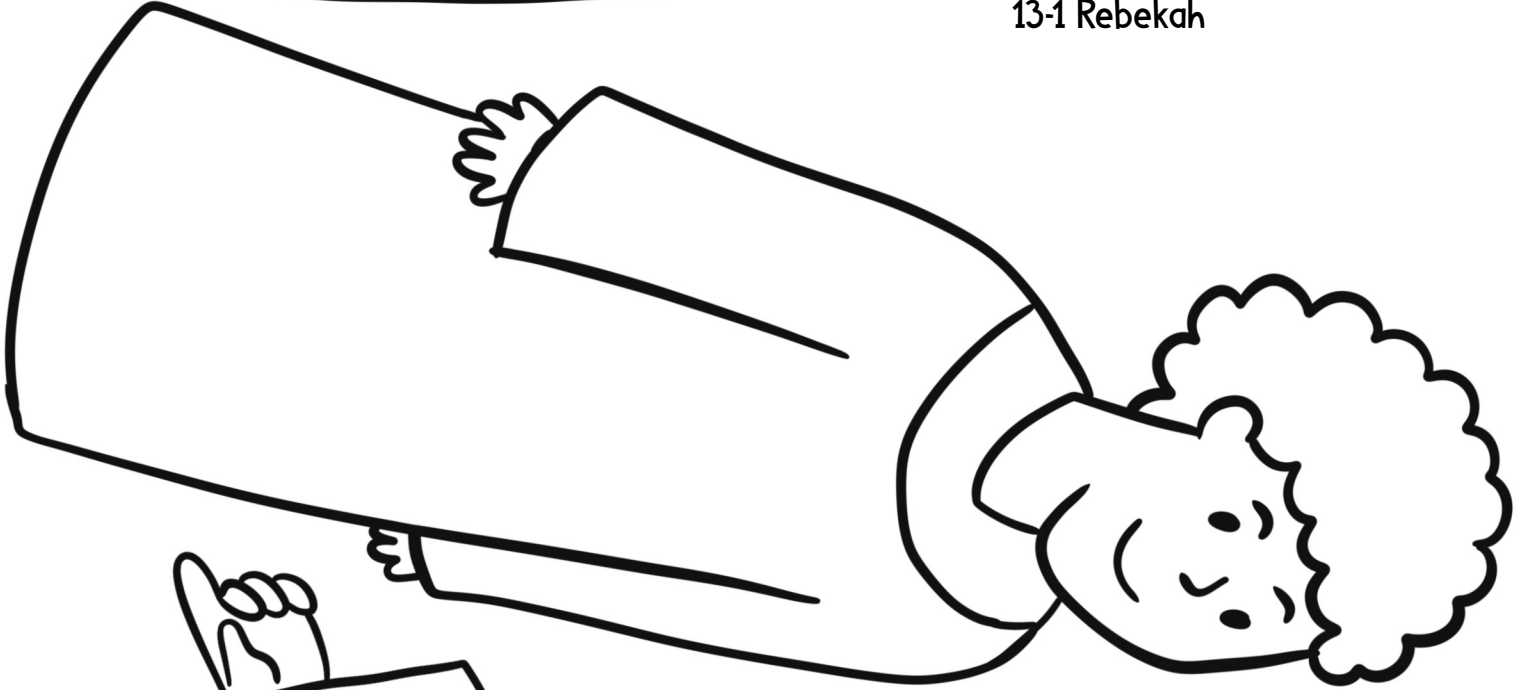

13-2 Isaac

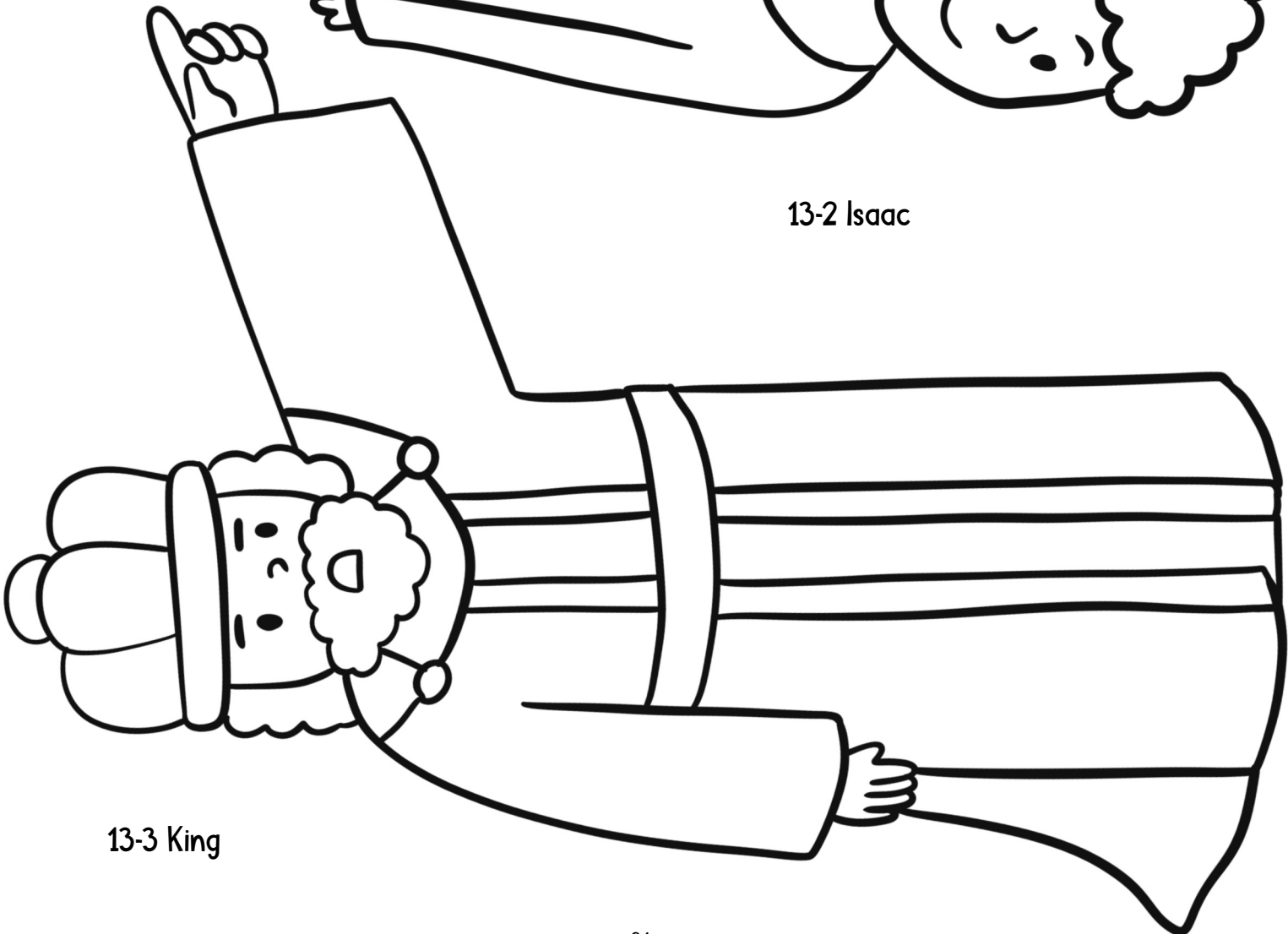

13-3 King



13-5 Sickle

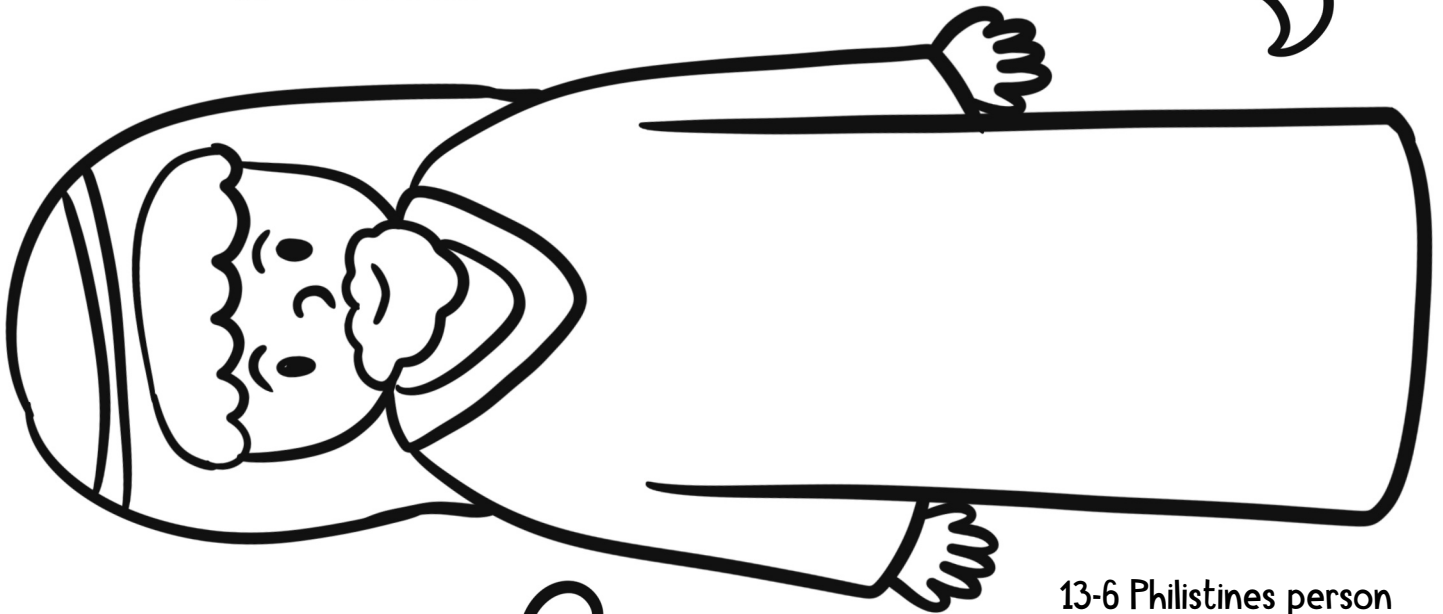

13-6 Philistines person

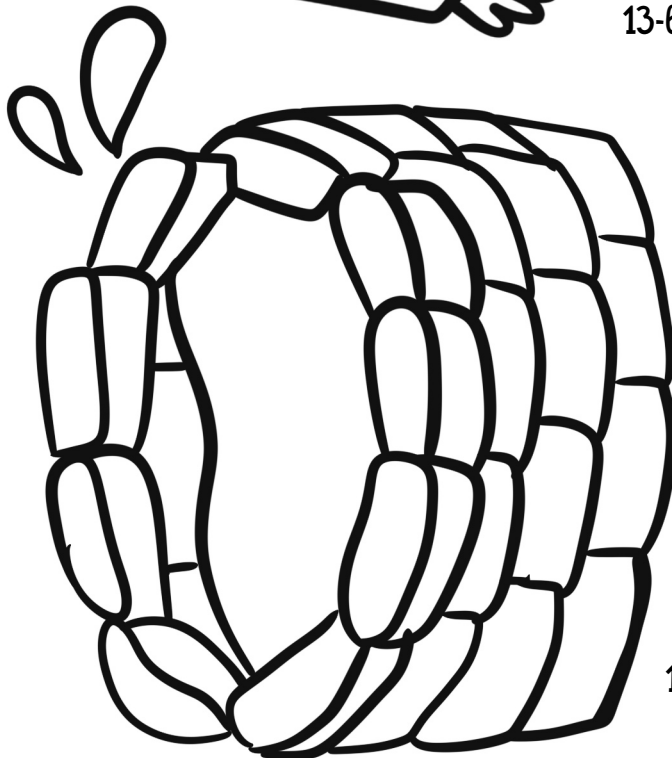

13-7 well

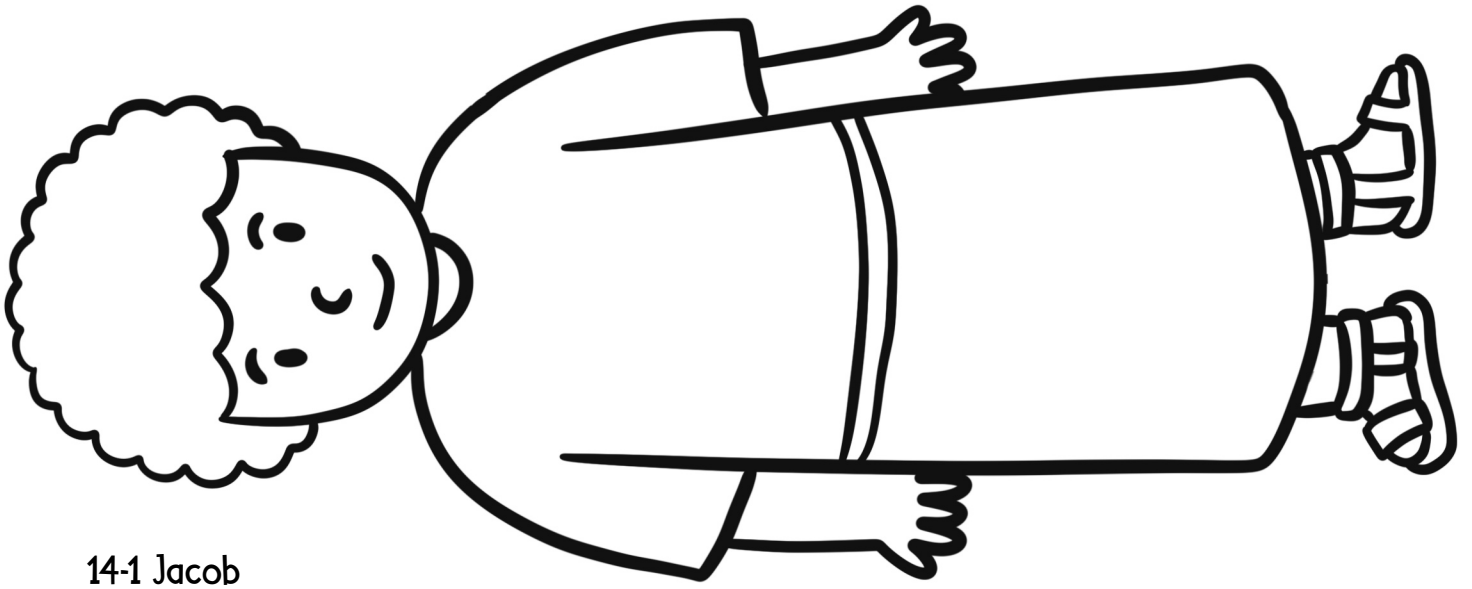

14-1 Jacob

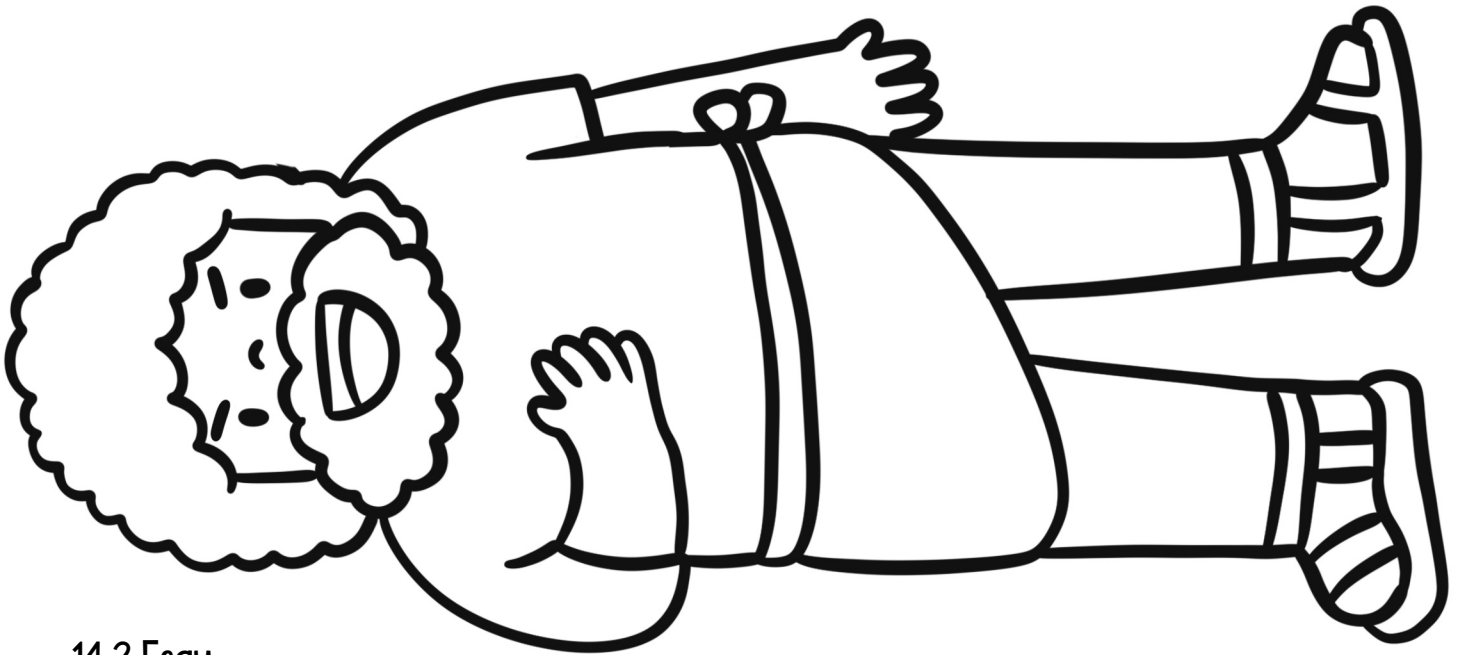

14-2 Esau



14-3 Isaac



14-4 soup

14-5 Ram

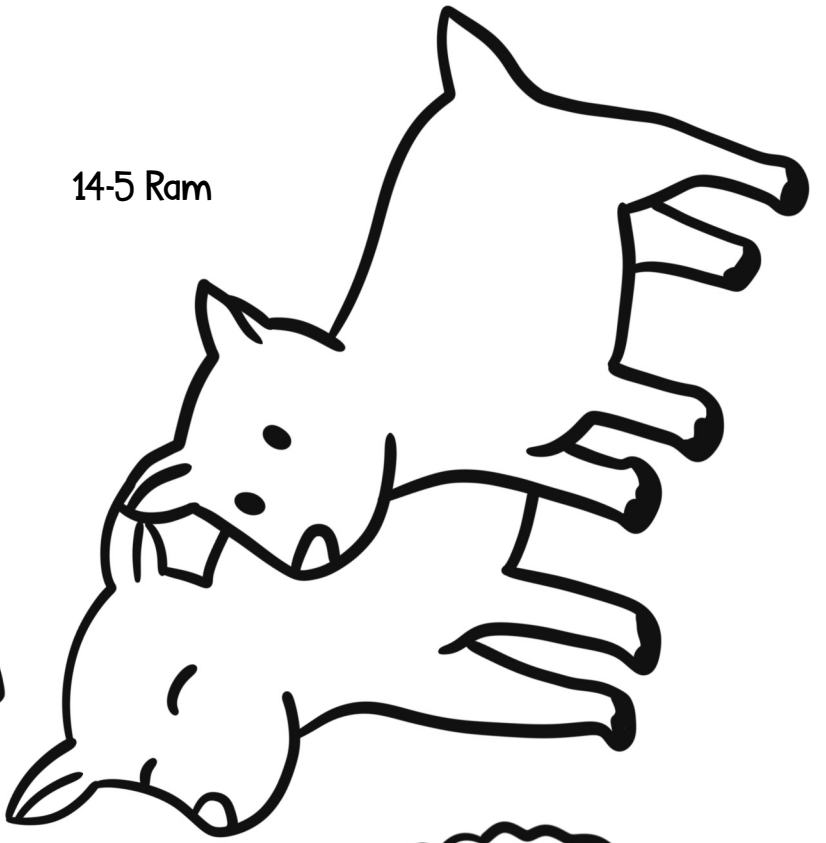

14-6 Furl clothes for Jacob

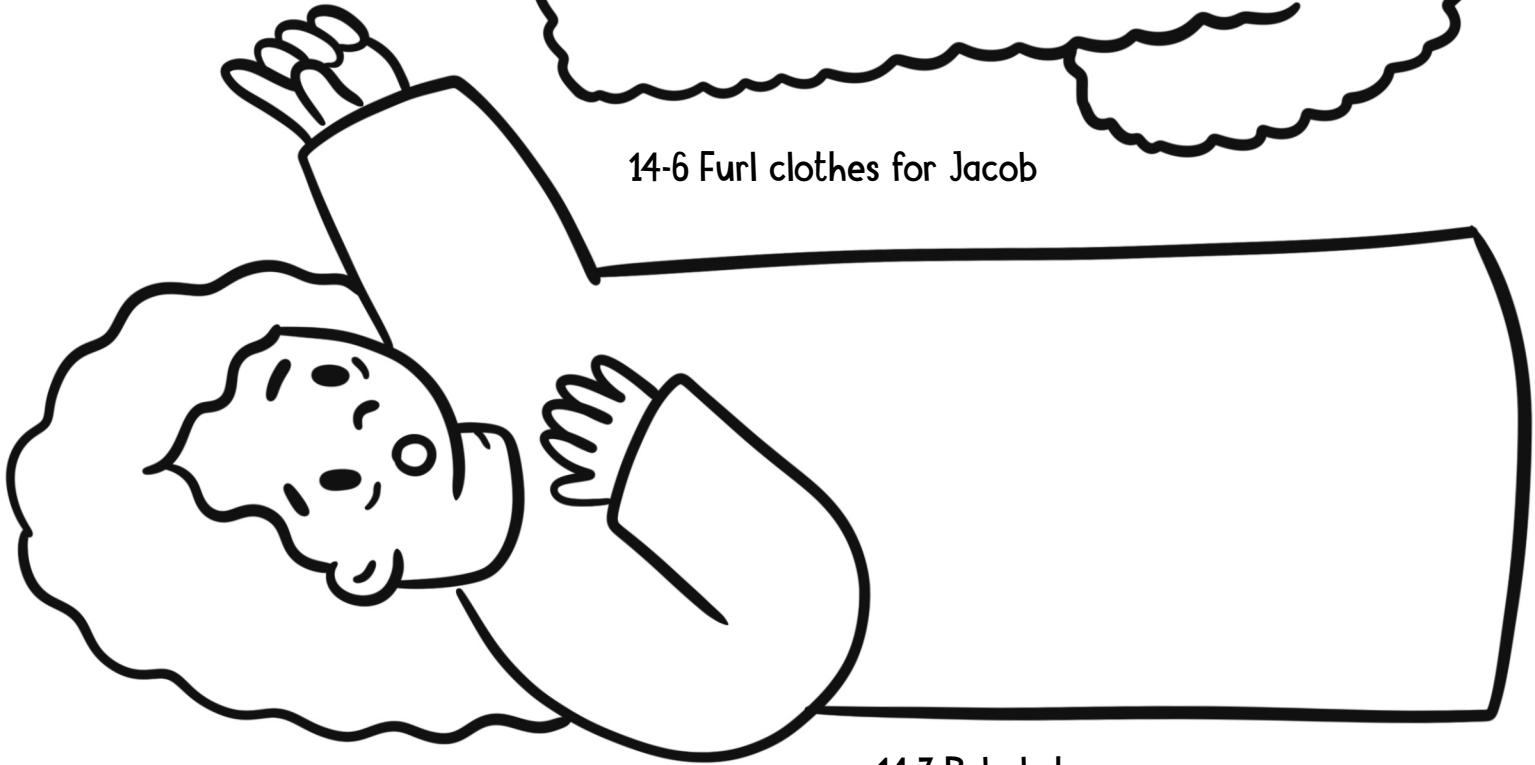

14-7 Rebekah

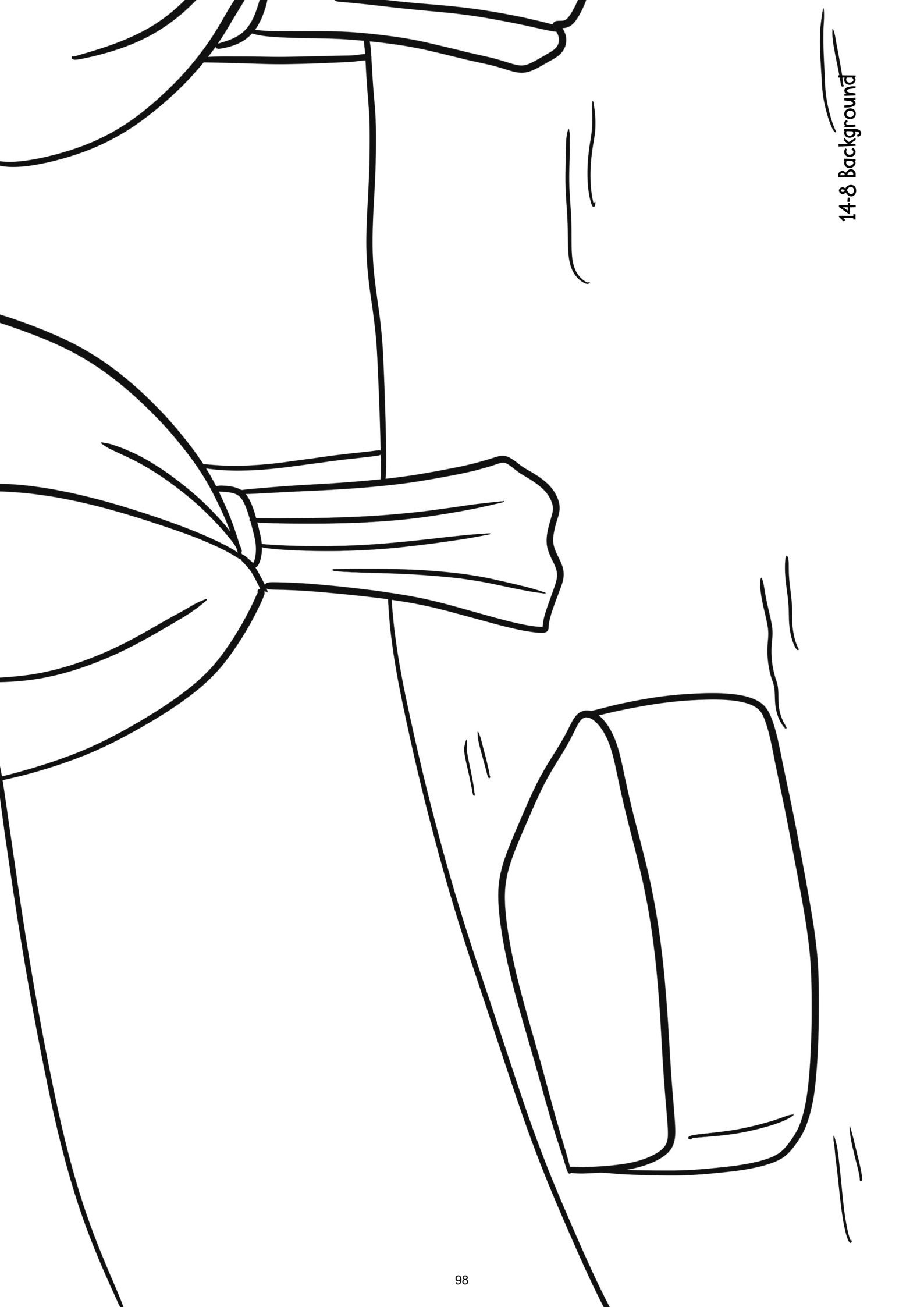



15-2 Crying Esau



15-1 Meat

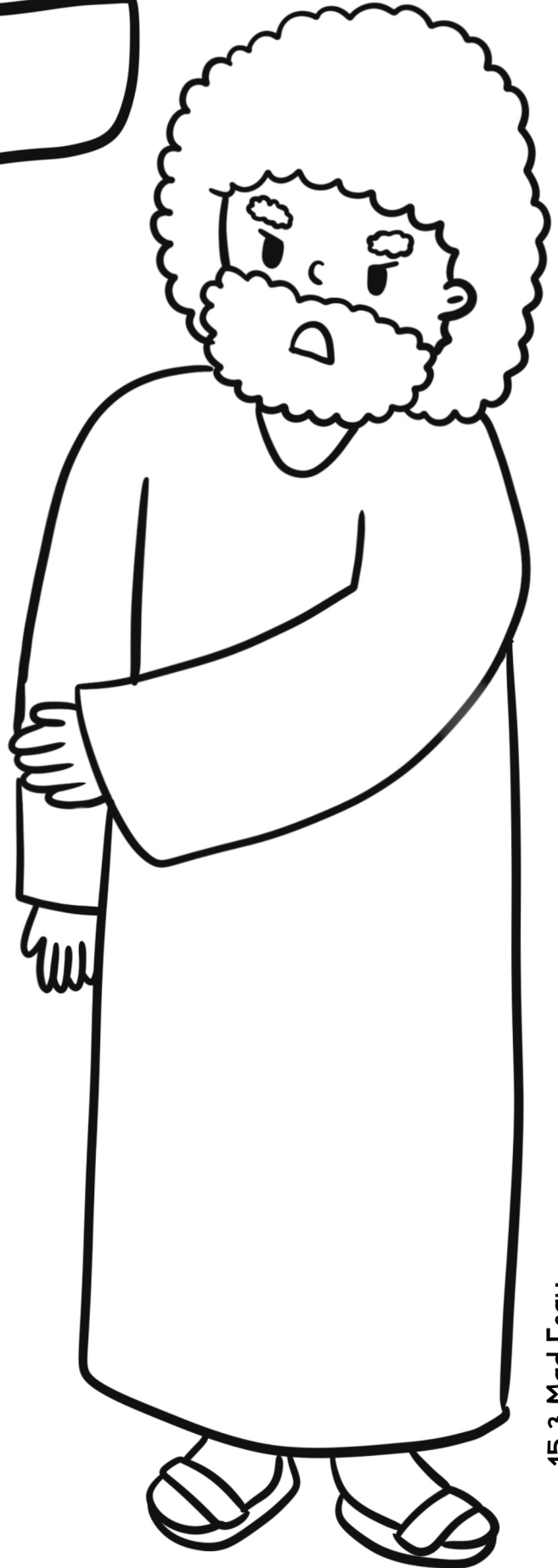

15-3 Mad Esau

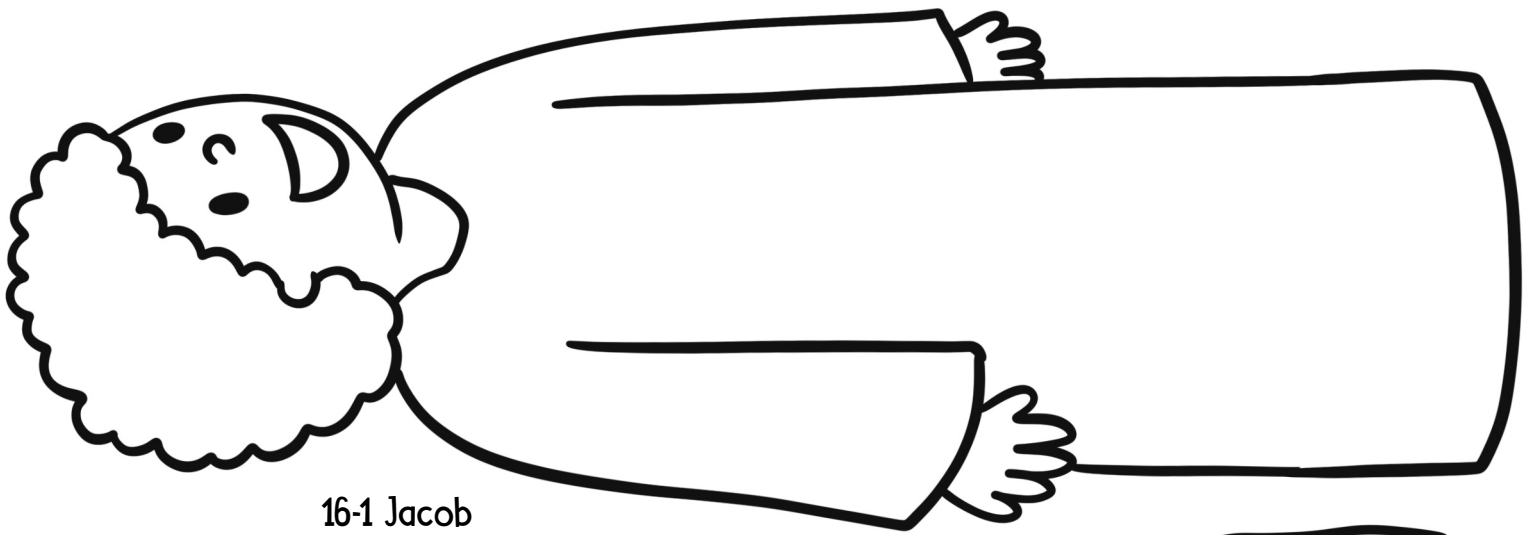

16-1 Jacob

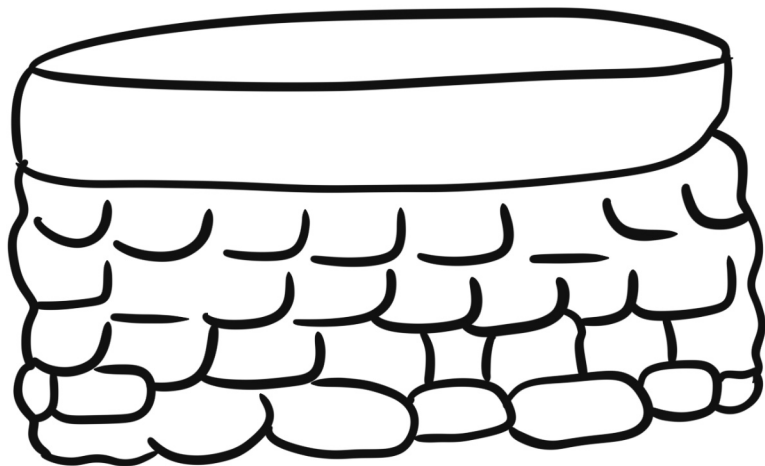

16-2 Well

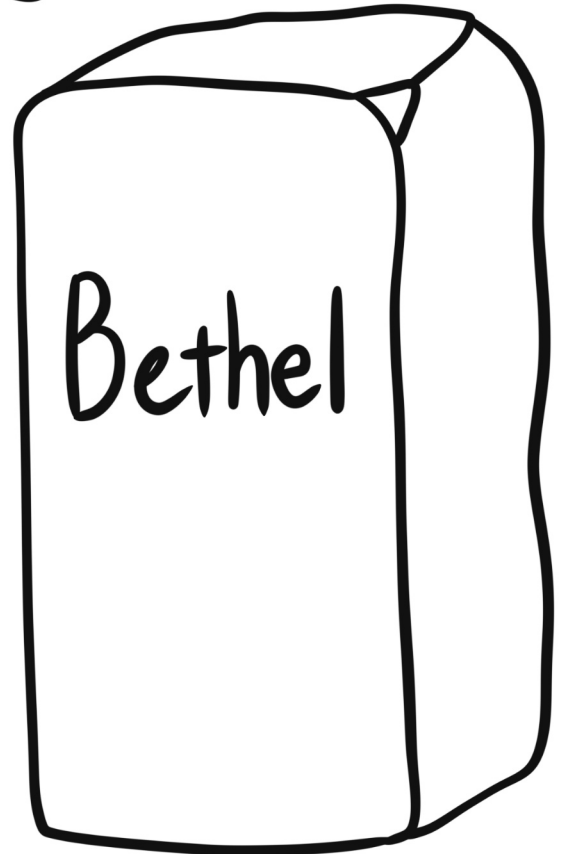

16-3 Stone pillar

16-4 Shepherd
and sheep

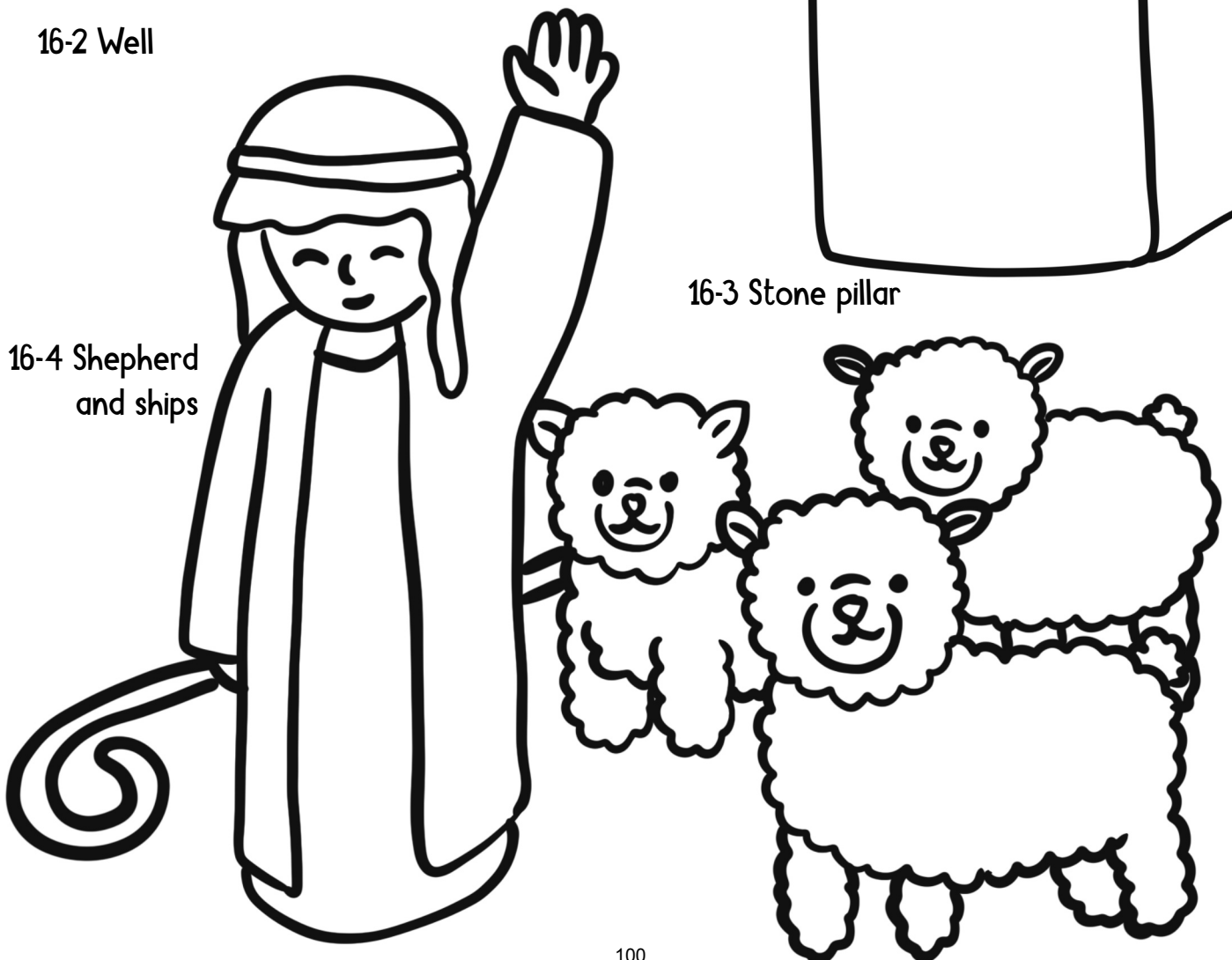

16-5 ladder and angel

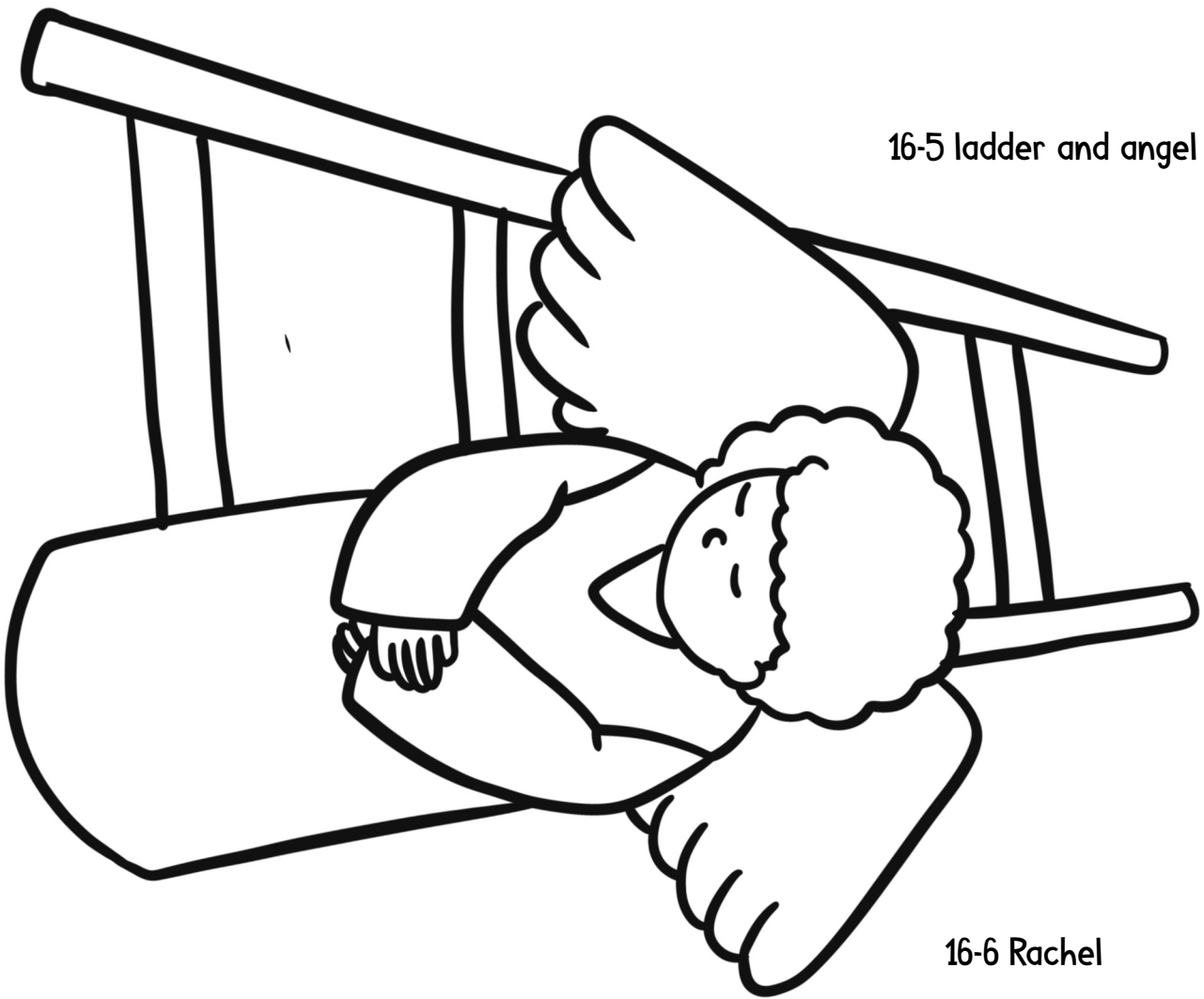

16-6 Rachel

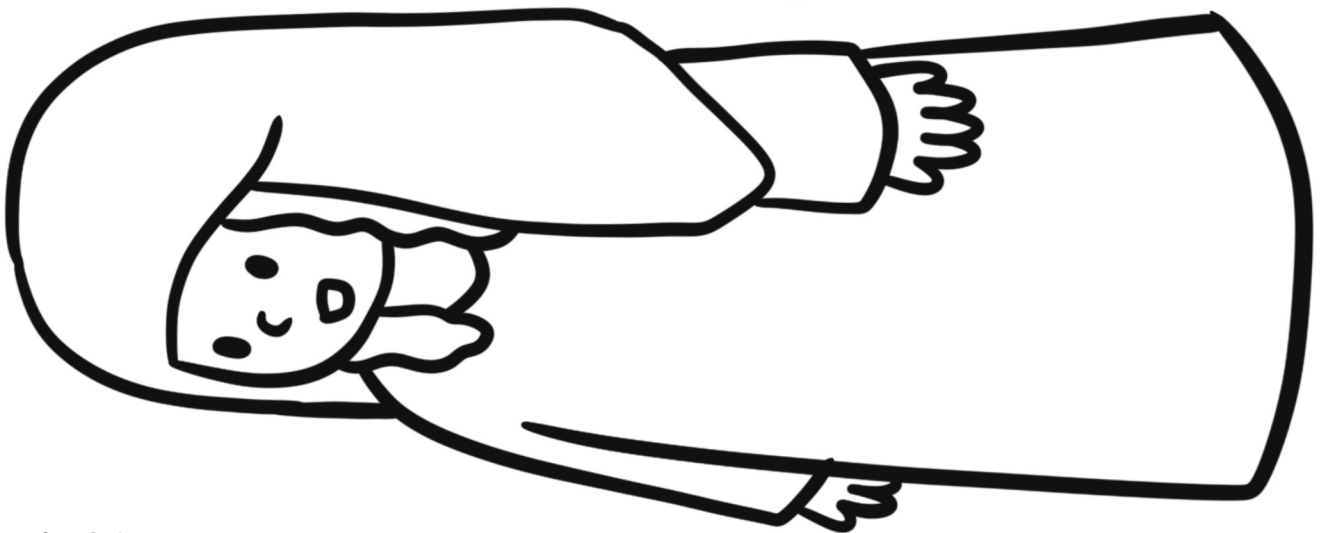

16-7 laban

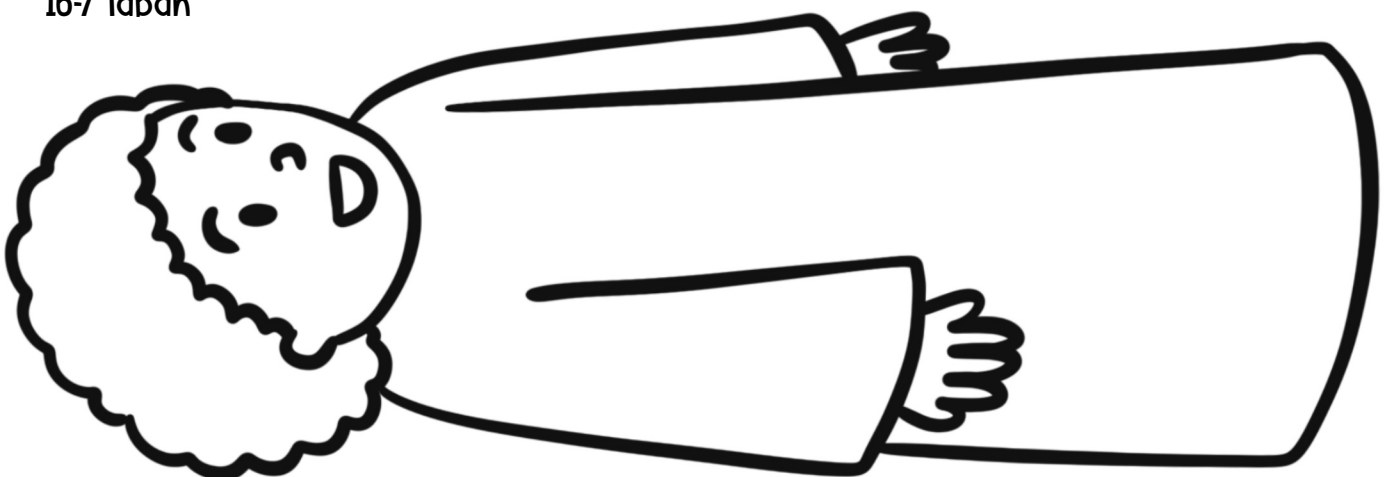

17-1 Mad Laban

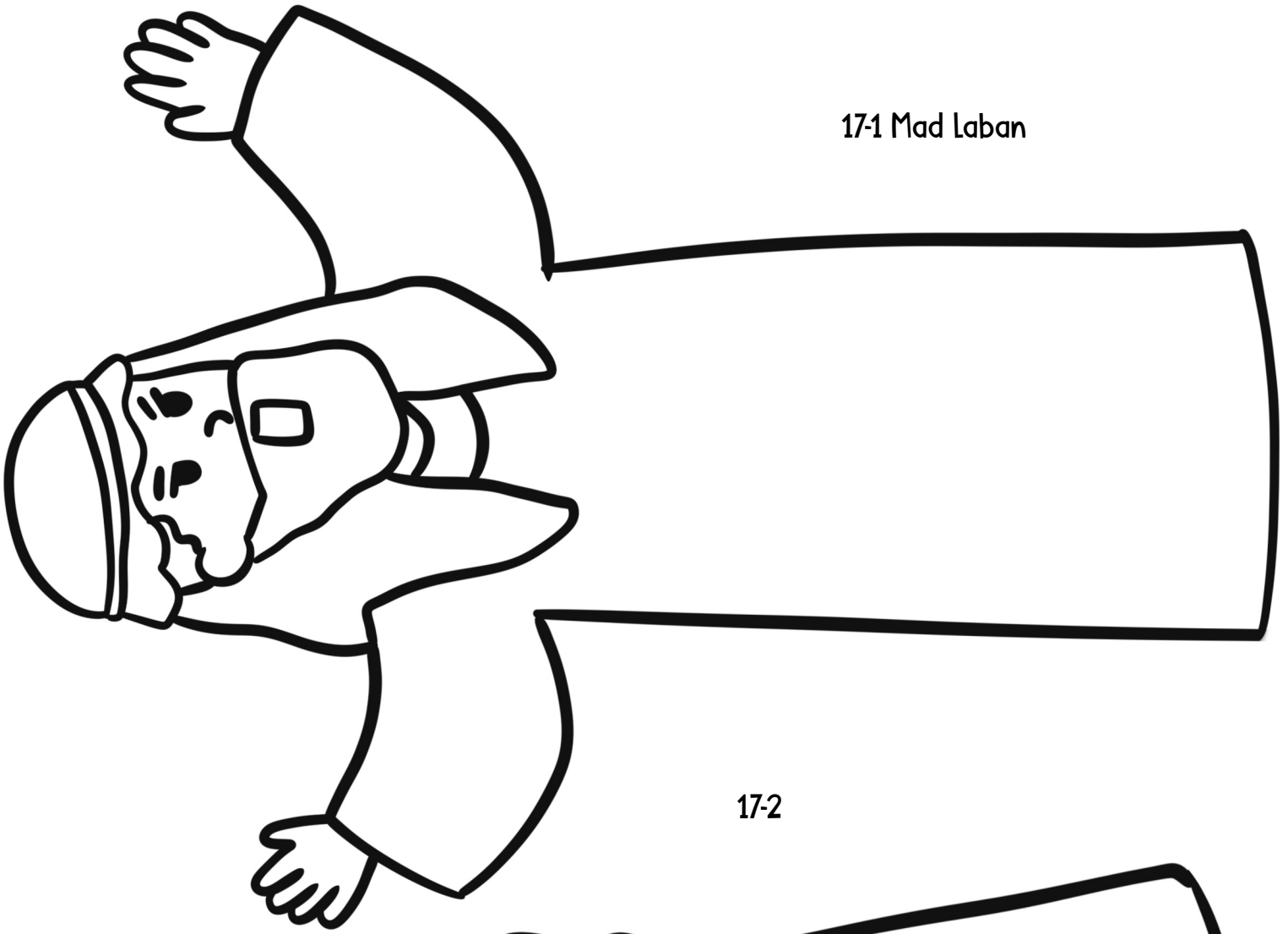

17-2

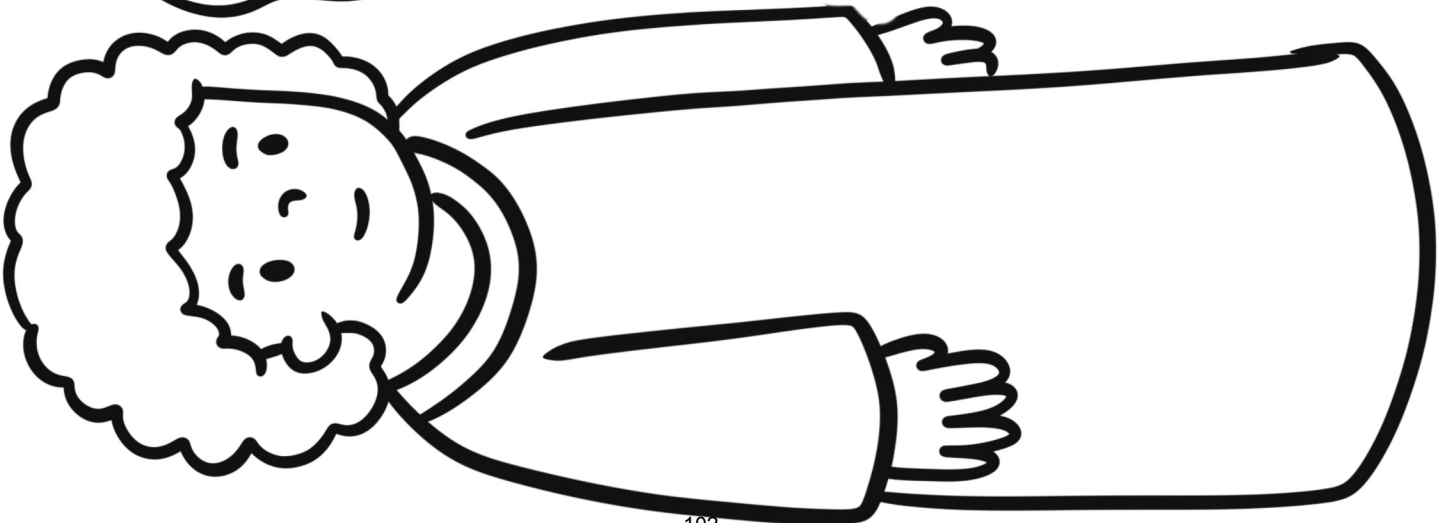

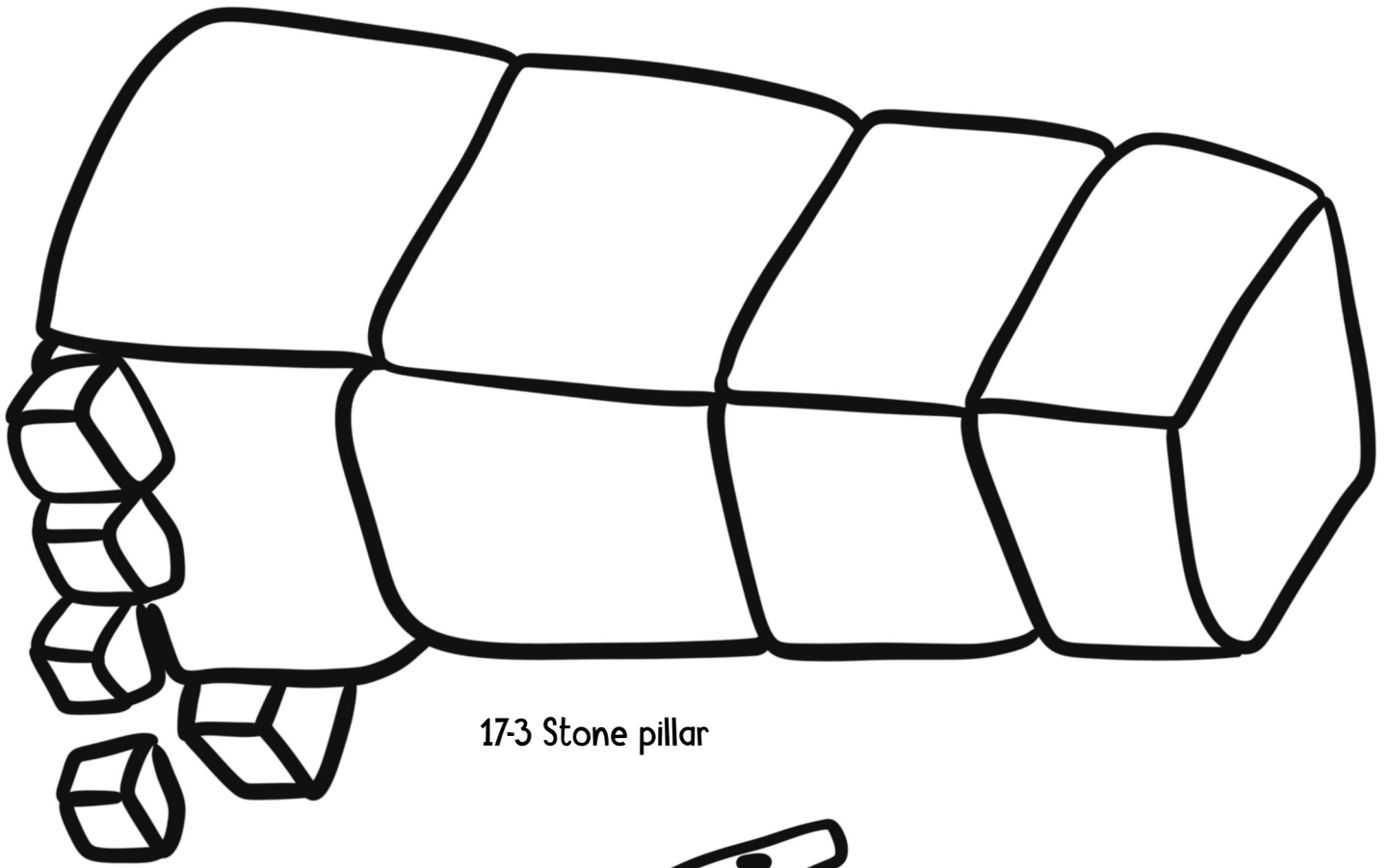

17-3 Stone pillar



17-4 Sheeps