

TEACHER'S BOOK

BIBLE STORY 3



MEDITATION (BIBLE VERSES FOR TEACHERS)

When Jesus saw it, he was angry and said to them, "Let little children come to me, and do not forbid them; for such is the kingdom of God" (Mark 10:14).

Truly I tell you, whoever does not receive the kingdom of God as a little child will never enter it (Mark 10:15).

Teach a child in the way he should go, and when he is old he will not depart from it (Proverbs 22:6).

He said to them, "Whoever welcomes such a little child in my name welcomes me; and whoever welcomes me welcomes the one who sent me. He who is the least of all of you is the greatest." (Luke 9:48)

SUNDAY SCHOOL WORSHIP ORDER

1. Worship and praise
2. (Apostles' Creed) Representative Prayer
3. Bible reading (with action)
4. Sermon (Bible Fairy Tale)
5. Offering prayer
6. Lord's Prayer
7. Advertisements
(Welcome to new friends, etc.)
8. Activities after worship
(feedback/ coloring book/ game activity)



LET'S PRAISE THE LORD!

SONGS

1. I am dancing with my feet
2. Salvation train
3. Wonderful, wonderful
4. One one way
5. Trip to the bible
6. Arise and sing

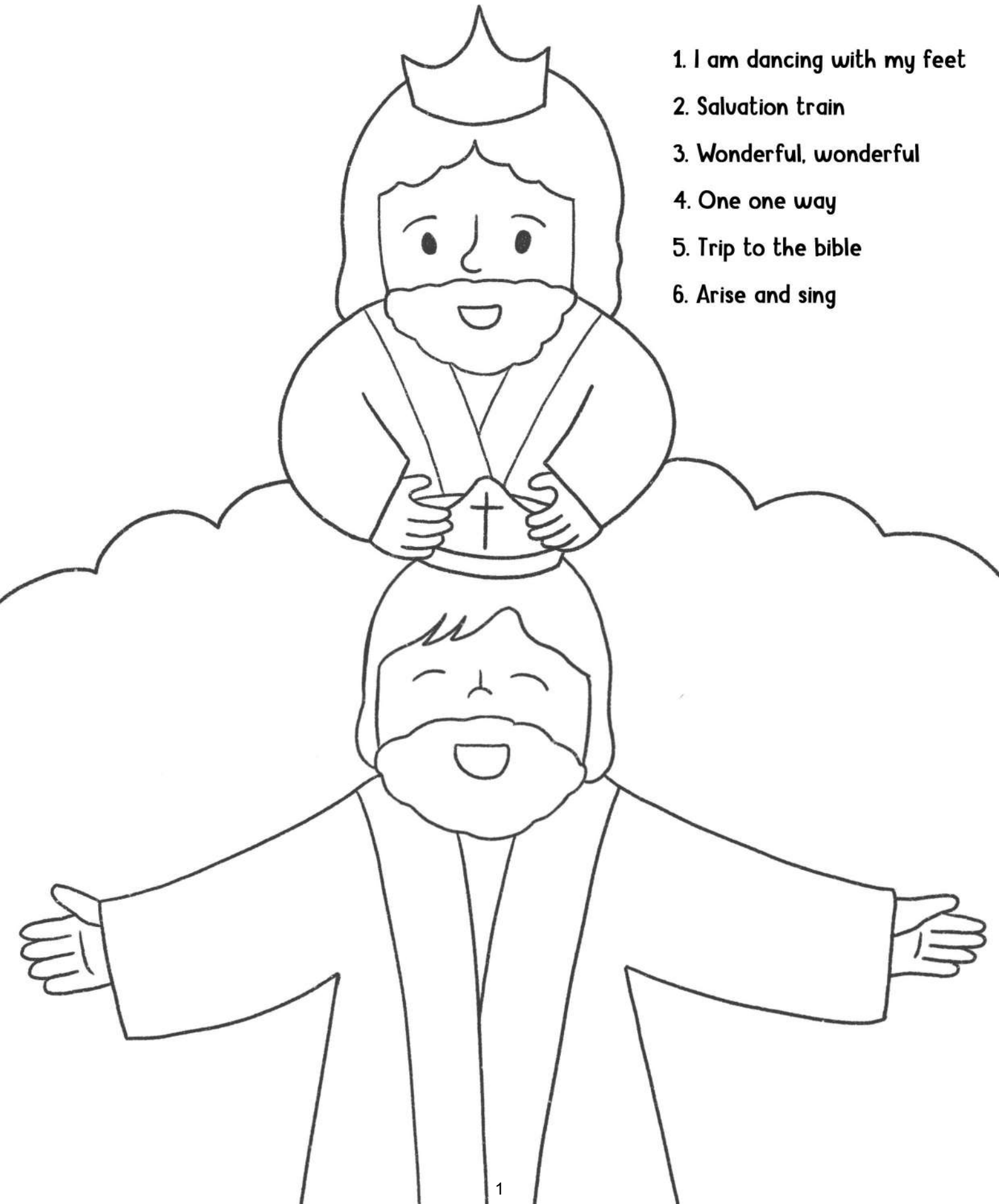

1. I am dancing with my feet

I am dan cing with my fe-et, I am clap ping with my ha-nds and I am sing ing with my lips for
 5 joy(Oh Lord!) I am dan-cing with my fe-et, I am clap-ping with my hands and I
 8 am sing-ing with my lips for joy I - wor-ship you oh Lord. I - wor-ship you oh
 13 Lord. I - wor-ship you my Lord and I love you, Lord.

2. Salvation train

I'm traveling on a Hallelujah train, my way to heaven(choochoo)
 I am on the right track, never will turn back to the station of sin.
 I don't need any ticket, for the Lord is my captain It is real fun you to go(choochoo)
 I'm traveling on a Hallelujah train, my way to heaven

3. Wonderful, Wonderful!

E *A* *E*
 Wonderful! Wonderful! The love of Jesus.
A *B7* *1.A* *E*
 His love is hotter than the sun up in the sky
2.A *E* *Fine* *A* *B7*
 sun up in the sky When Jesus died on the
E *A* *B7*
 cross for us. He gave his life so that
E *D* *B7* *D.C.*
 we could be free. How wonderful is his love

4. One One Way

One One way One One way There is no other way
 5 *To Coda*
 One One way One One way Jesus is the only way only through
 9
 Je ~ sus we can go to hea ~ ven
 13
 Jesus~ One way~ There's no other way Only Jesus way

5. Trip to the bible



Let's go on a trip into the bible stories (listen to word of God!)



Let's hold Jesus' hand and walk into the bible (listen to word of God!)



We'll see the beautiful stories. By hearing thr God's history



Countless, wonderful words of God. Are you ready to TRIP TO THE BIBLE



Let's go on a trip into the bible stories (listen to word of God!)



Let's hold Jesus' hand and walk into the bible (listen to word of God!)

6. Arise and sing

Mel Ray

Arise and sing, ye children of Zion. For the Lord has delivered thee-GLORY





Arise and sing, ye children of Zion. For the Lord has delivered thee

Open your heart and rejoice before him Open your heart and rejoice before him





Open your heart and rejoice before him. For the Lord is your God

ACTING WORD



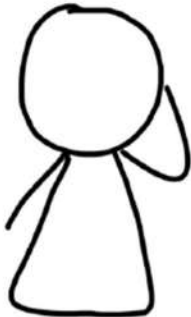



1. The scriptures must be fulfilled (Mark 14:49)

The		clap
scriptures		open both hands to the side
must		right hand up
be		left hand up
fulfilled		twinkle twinkle gesture

2. Then Peter remembered the word Jesus had spoken to him (Mark 14:72)





Then Peter	 <p>A stick figure with a circular head and a triangular body. The right hand is on the chin, and the left hand is on the chest. Arrows point from the hands towards the center. Circled numbers 1 and 2 are next to the right and left hands respectively.</p>	right hand on chin down to chest and left hand do the same
remembered	 <p>A stick figure with a circular head and a triangular body. The right hand is raised to the side of the head.</p>	right hand point the head
the word Jesus	 <p>A stick figure with a circular head and a triangular body. Both hands are held out to the sides, palms facing forward.</p>	opening the book gesture
had spoken	 <p>A stick figure with a circular head and a triangular body. Both hands are raised to the mouth area.</p>	both hands to mouth
to him	 <p>A stick figure with a circular head and a triangular body. Both thumbs are pointing towards the shoulders.</p>	both thumbs point the shoulder

3. As I have loved you so you must love one another (John 13:34)

As I have		one thumb point the chest
loved		draw a small heart in front of you
you		one hand open and forward
so you		both hands meet at the center and draw round to each side
must love		draw bigger heart
one another		right hand to the waist and left hand draw round from right to left

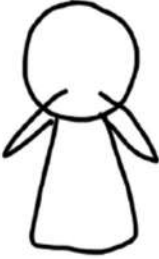
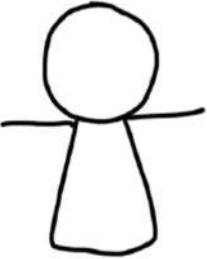



ACTING WORD

4. You proclaim the Lord's death until he come (1 Corinthians 11:26)

You		right hand to front
proclaim		both hands on mouth like speaking gesture
the Lord`s		both hands straight to each side
death		drop the head down
until he		both hands up
comes		both hands draw down





ACTING WORD

5. Everyone on the side of truth listens to me (John 18:37)

Everyone		right hand draw a round from center to the right side
on the		left hand draw a round from center to the left side
side of truth		clap above your head and bring both hands down to chest
listens to		right hand to right ear
me		both thumbs point each shoulder





ACTING WORD

6. Jesus of Nazareth, the king of the Jews (John 19:19)

Jesus / of		right hand straight to right side / left hand straight to left side
Nazareth		drop the head down
the king		right thumb at center
of the		left hand under the right thumb
Jews		both hands raise up





ACTING WORD

7. Today you will be with me in paradise (Luke 23:43)

Today		right hand point up
you		right hand down to center
will be		right hand draw round at center
with me		both hand cross to chest
in paradise		turn around with twinkle twinkle hands





ACTING WORD

8. Father, into your hands I commit my spirit. (Luke 23:46)

<p>Father</p>		<p>right thumb with left palm under it at the center close to your body</p>
<p>into</p>		<p>both hands move forward</p>
<p>your hands</p>		<p>open the right thumb to palm so both palms are facing up</p>
<p>I commit</p>		<p>both hands raise up</p>
<p>my spirit</p>		<p>drop both hands to each side to make cross</p>

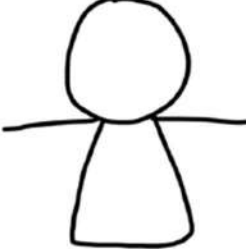
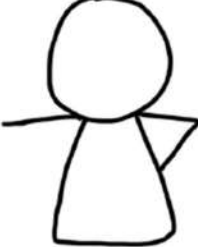



ACTING WORD

9. Be crucified and on the third day be raised again (Luke 24:7)



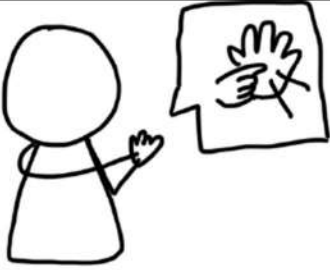
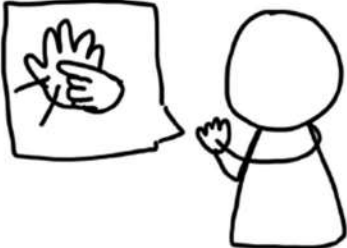



Be		right hand straight to right side
crucified		left hand straight to left side
and on the		right hand to the waist
third day		left hand makes number 3
be raised		left hand raise up
again		right hand raise up

ACTING WORD

10. Look at my hands and my feet. It is myself, touch me and see (Luke 24:39)





Look at		use left hand's finger to touch right palm
my hands		use right hand's finger to touch left palm
and my feet		both hands on forehead and look down
it is / myself		right hand open to the right side / left hand open to the left side
touch me		both hands cross at the eye level
and see		both hands to the eyebrow like seeing gesture

11. Do you love me more than these? Yes, Lord, you know that I love you. (John 21:15)

Do you		right hand shape the half of the heart at the center
love me		left hand shape the other half of the heart and combine with the right hand
more than these?		both hands draw big circle by having twinkle twinkle gesture
Yes / Lord		clap x 2
you know that		both hands to the chest
I love you		use both index fingers to draw big heart



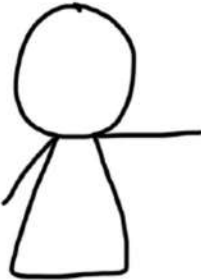
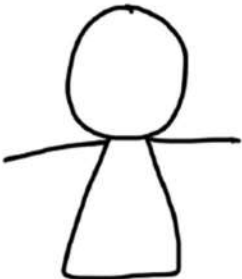

ACTING WORD

12. You proclaim the Lord's death until he comes (1 Corinthians 11:26)

You		right palm to front
proclaim		both hands to mouth
the Lord's		right hand straight to right side
death		left hand straight to left side
until he comes		both hands slowly raise up







ACTING WORD

13. Jesus will come back in the same way you have seen him go into heaven (Act 1:11)

Jesus		right thumb up in right side
will come back		right thumb down to center
in the same way		right thumb make a big horizontal circle
you have seen him		left hand to left eyebrow
go into heaven		left hand raise up



ACTING WORD

14. Silver or gold I do not have, but in the name of Jesus Christ of Nazareth, walk (Act 3:6)

Silver or		right hand shapes money sign
gold		left hand shapes money sign
I do not have		mark X with right hand while left hand below the right elbow
but in the name of		right thumb at the center
Jesus Christ		left palm below the right thumb
of Nazareth		raise both hand to up
walk		walking gesture

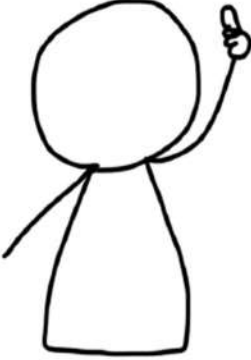

ACTING WORD

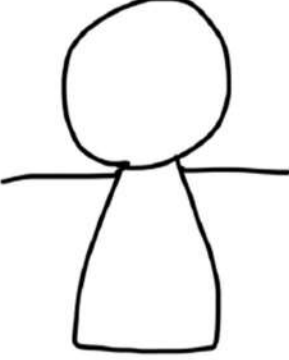
15. Lord, do no hold the sin against them (Act 7:60)





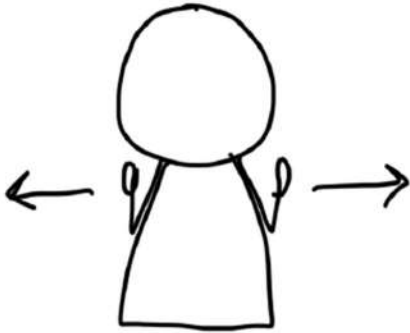

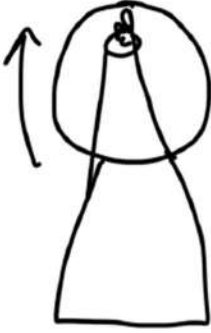
Lord	 A simple line drawing of a stick figure with a round head and a trapezoidal body. The right arm is raised, with the thumb pointing to the right.	raise the right thumb to right side
do not	 A simple line drawing of a stick figure with a round head and a trapezoidal body. The hands are raised and crossed in front of the chest, forming an X shape.	make a X shape with both hands
hold the sin	 A simple line drawing of a stick figure with a round head and a trapezoidal body. The hands are raised and held together at the elbows, forming a straight line across the chest.	just down the hands to touch elbow to make straight line
against them	 A simple line drawing of a stick figure with a round head and a trapezoidal body. The hands are held straight out to the sides, parallel to the ground.	open wide the hands straight to each side

ACTING WORD

16. By the Holy Spirit, it grew the numbers living in the fear of the Lord (Act 9:31)

<p>by the Holy Spirit</p>		<p>right hand raise up to right side</p>
<p>it grew the numbers</p>		<p>both palms from the shoulder line stretch wide</p>
<p>living in the fear</p>		<p>both hands to the chest and drop the face down</p>
<p>of the Lord</p>		<p>raise the right thumb up with the left palm under it</p>

17. Behold, I am coming soon. Blessed is he who keeps the words of the prophecy in this book (Rev 22:7)

Behold		both hands at the waist and nod
I am		right thumb raised to right side
coming soon		down the right thumb to center
blessed is / he who		right hand make a round to right side / left hand make a round to left side
keeps the		each hand touches the otherside`s elbow to make a straight line
word of the prophecy		opening book gesture
in this book		raise both hands high

ACTING WORD

SERMON COMMENTARY

1. Judah who betrayed Jesus

My beloved friend, Jesus was arrested even though He was innocent. His disciples left Him, and Judas told the soldiers about Jesus. Why did all of this happen? It was part of God's plan. God had a special plan for us because we have sins and cannot go to heaven on our own. That's why someone needed to take our sins away. Wouldn't it be great if there was something in the supermarket that could get rid of our sins? But in this world, there is nothing that can remove sins. That's why God sent His Son, Jesus, who was without sin, to us. So Jesus was arrested and crucified. After that, He took away all our sins by sacrificing Himself on the cross. If we repent of our sins, we receive forgiveness. Because of Jesus' sacrifice and love, we have become children of God and people of heaven. We should be thankful and show love to Jesus every day.

2. Lies

My beloved friend. Peter denied Jesus because he was scared of people. Even though Peter had seen many miracles and experienced love, he lied. Peter was scared. But when the rooster crowed twice, he remembered what Jesus had said and felt sorry for lying. We also lie to Jesus sometimes. On Sundays, when we're supposed to go to church, if something fun happens, we might choose to watch TV, hang out with friends, sleep in, or go to the playground instead of going to church. Since we are God's children, it's important for us to go to church and worship. Also, when our friends bother us, we often don't forgive them and feel angry. Jesus told us to love everyone. Let's forgive and love our friends so that they can meet Jesus. That love is God's love, and it shows that we are God's children. Let's pray that we can be like that. Just like Peter lied and cried before Jesus, let's pray to Jesus and say sorry for our mistakes. And let's try to have faith and become God's children. We have received Jesus' love, so let's share that love with our friends and family. That love will make God happy.

3. Jesus washing his disciples' feet

My beloved friend. Jesus said that washing the disciples' feet was a way to show love. Back then, people walked in the desert, and their shoes were different from ours, so their feet got very dusty. Jesus showed them how to help those who needed it. Let's think about who needs us, like our parents or friends. We can show them a lot of love. We should listen to our parents, pray for them, and express love to our family. And let's praise and encourage each other with joy. Every day, tell your family you love them and are thankful. They will be so happy. This way, people will see Jesus' love in us. Show kindness and love to your friends too. Compliment them, be understanding, and care for them, sharing Jesus' love. Just like Jesus washed the disciples' feet, let's also take care of our neighbors and friends. Jesus will say, "Well done!" and praise us.

4. Last dinner with Jesus

My beloved friend. Jesus gave bread to the disciples and said it is His body. He did this to take our sins upon Himself and make us children of God. Jesus was nailed to the cross for our sins to be forgiven. He also referred to the wine as His blood. It symbolizes how Jesus took our sins upon Himself, endured the nails in His hands and feet, wore a crown of thorns on His head, and shed His blood for us. Through His loving sacrifice, we can pray to Jesus and ask for forgiveness, and our sins will be forgiven. This is the love of Jesus on the cross. With this love, we can be freed from sin and enter the kingdom of heaven. Let's be grateful for this love and follow the Ten Commandments, love our neighbors, attend Sunday worship, and give thanks in all things, showing that we are children of God. Jesus will cheer for us when He sees us doing these things. Now let's share Jesus with our friends through this love.

5. The trial of Jesus

My beloved friend. Even the judge, Pilate, knew that Jesus was innocent. But the people who saw Jesus perform miracles shouted for Him to be crucified. How could this happen? It was because the chief priests and elders envied and hated Jesus. They made up false stories to make people hate Him. We shouldn't lie like them. We should always be truthful and live righteously. Jesus wants us to be like that. He prays for us to have good hearts and be good people. Let's take this time to repent and pray, asking Jesus to forgive us for any bad thoughts, lies, wrong actions, jealousy, or hatred in our hearts. Jesus will be delighted by our sincere efforts.

6. Jesus is nailed to a cross

My beloved friend. Why did Jesus, who did nothing wrong, choose to carry the cross? It was part of God's plan. God sent His Son, Jesus, to the world to help us and take away our sins. We humans cannot forgive our own sins, so God sent Jesus to do it for us. Jesus was sinless, which allowed Him to take on our sins. That's why He came to Earth in human form and was crucified on the cross. Because of Jesus' sacrifice, we can receive the grace of forgiveness for our sins. By believing in Jesus and admitting our sins, we can become God's children and be saved. This means we can go to heaven. Let's express our gratitude, praise, and love to Jesus. Let's be thankful for His love. Share Jesus' love with our family, friends, and neighbors.

7. The thief on the cross was saved

My beloved friend. We need to make good choices while observing two robbers. One robber made fun of Jesus and missed the chance to be saved. The other robber recognized himself as a sinner and repented, humbly asking Jesus to save him. As a result, he believed in Jesus and was able to enter heaven. We can also be saved and go to heaven if we confess our sins to Jesus. Jesus sacrificed Himself on the cross to bring us to heaven. By believing in Jesus alone and confessing our sins, we receive forgiveness through the love of Jesus, who shed His blood on the cross for us. We are thankful to Jesus for giving us salvation. Let's love Jesus with all our hearts and not be afraid of death, focusing our love, faith, and hope only on Him.

Thank you, Jesus. We love you for saving us.

8. Death of Jesus

My beloved friend. Why didn't Jesus perform miracles to save Himself? Why didn't He say anything when people arrested Him and nailed Him to the cross? Even though Jesus is God's Son, why did He choose to endure pain? All of this was part of God's plan. God wanted to send us to heaven, but our sins were a problem. So, He sent Jesus to us, and by dying on the cross, our sins could be forgiven, and we could be saved. Jesus' death was the way for us to receive forgiveness. He took our sins upon Himself, even though He was without sin, and opened the path to heaven for us. We only need to believe in Jesus, confess our sins, and turn away from them, and Jesus will forgive us and change our destination from condemnation to heaven. My friends, we are now children of God and can worship Jesus and God in heaven. Let's express our gratitude and love to Jesus with our hearts. Let's rejoice, give thanks with joy, and meet the Lord in worship. Jesus will accept all our love for him

9. Jesus has risen

My beloved friend. Jesus rose from the dead after three days, but His disciples were not there. That could be our reflection. Many people witnessed Jesus' miracles but did not believe. Let's also consider our faith through Jesus' resurrection. Do we truly believe in Jesus, the Son of God? Does our faith confess that He is the Son of God within our hearts? Do we believe that Jesus died on the cross because of our sins, washed away our sins, and rose again after three days? Do we believe that if we believe in Jesus, confess our sins to Him, and ask for forgiveness, we can become God's children and go to heaven? Jesus will ask about our faith. In that moment, let's show Him our faith. Let's confess our hearts to Jesus, saying, "Jesus, I believe that You are the son of God, who went to the cross for me and rose again after three days. I thank You for forgiving my sins."

Through this confession, Jesus will know our faith in our hearts. Let's all confess to Jesus right now!

10. Touch me and see

My beloved friend. Jesus has risen again. He also appeared to His disciples. Thomas, who had doubts, couldn't believe it, so Jesus asked him to touch His hands and side. Jesus allowed Thomas to touch Him, and that's when Thomas believed. What about our faith? Is it a faith filled with doubt, like Thomas? Or do we believe in Jesus' words, obey them, and live accordingly?

Let's pray for faith. Jesus rose again after three days. He is an amazing God. Through Jesus, our wonderful God showed that He is the Son of God. Our loving God has revealed to us that we, too, are God's children through Jesus. We receive this amazing love from our God. Every day, share the love of Jesus with your family and friends with gratitude and joy. And every day, confess your love for Jesus.

11. Peter's confession

My beloved friend. How can we respond to Jesus' question? "Do you love me?" Let's answer in our hearts right now. If Jesus asked us three times, just like He did with Peter, how would you answer each time? If our beloved Jesus, who carried the cross for us, died and rose again, asked us if we love Him, I believe we would all say, "I love you, Jesus. Jesus, I love you so much."

Who in this world can bear the cross and die in my place? How can we not love Him who forgave our sins and sacrificed His life for us? Our parents may be willing to die for us, but they cannot forgive our sins. Yet, Jesus took all our sins upon Himself. How is it possible that only Jesus could do this? Because Jesus is the son of God. Every day, let's confess our love to Jesus, worship Him with gratitude, and show our love to Him as His children who share His love with others.

12. What we must do

My beloved friend. Jesus told us to tell others about Him. He said we should believe in Him and get baptized, and encourage our family, neighbors, and friends to do the same. Through baptism, Jesus shows us how to believe in Him and gives us the power of the Holy Spirit. Our Lord Jesus has gifted us with baptism, and through it, He grants us the grace of salvation. Now, when we believe in Him, we receive salvation, which allows us to enter the kingdom of heaven. Let us express our gratitude and love for Jesus through daily praise and worship. And let's follow Jesus' command to share the good news with everyone in the world, our family, neighbors, and friends. Jesus will be very happy when we do this. Let's be good friends who do our homework well.

13. Jesus will come just like he went into heaven

My beloved friend. Jesus rose from the dead and taught His disciples for 40 days. He promised to return to us when He ascended to heaven. Isn't that amazing? Jesus is coming back again! Although He hasn't come yet, we are grateful and joyful because we will live with Him in heaven, praising God in eternity. We believe in Jesus' promise and wait before God in prayer. By keeping His commandments with faith, we can wait faithfully. We just need to share the message of Jesus, love our neighbors, and live according to God's word. Let's praise Jesus every day, expressing our love and gratitude, and pray to Him. While eagerly waiting for Jesus to return as He ascended, let's actively spread the good news. Jesus will surely praise us for our efforts when He comes back.

14. Peter and John healed a lame man

My beloved friend. Are our families believing in Jesus together, worshiping Him, loving one another, and praying? If not, we need to pray for our families. It's also a sad thing if our friends don't believe in Jesus. Believing in Jesus is the only way to go to heaven and to receive salvation. No matter how good we live, if we don't believe in Jesus, we can't go to heaven. We must believe in Jesus, repent of our sins, and share His love with our neighbors. Even Peter and John experienced great miracles when they prayed in faith. Although we can't do it by ourselves, let's pray in faith and share it with our parents and friends. Jesus will remember your prayers and help you all. Let's never give up but pray and strive to lead others to believe in Jesus. Let's share Jesus' love with others, just as He loved and saved us. Jesus will be so happy about it.

15. Stephen was stoned to death

My beloved friends. Stephen was a servant of God who was full of grace and power. He took care of and helped many people, so he was well-liked by them. However, some bad people and elders made false accusations against Stephen and unfairly twisted his words to make him look guilty. Even the high priest didn't understand Stephen. Because of all the false claims, the crowd unjustly threw stones at Stephen until he died. But Stephen never betrayed Jesus and bravely told people about Him, just like an angel. Our friends, we might feel sad about Stephen's unfair death, but Jesus would have praised Stephen for not giving up on Him and continuing to spread His message. Why? Because Jesus had already prepared a place for Stephen in heaven, and God's praise was waiting for him. Dear friends, even if we feel mistreated and find life difficult right now, we need to look to Jesus and heaven and overcome all the lies and false accusations from the world and our friends. Let's also pray for them.

16. Saul became Paul

My beloved friends. Just as Jesus opened the way to spread the Gospel throughout the world through Saul, now He will also open a way for us to proclaim Jesus. Just as Saul met Jesus and became Paul, sharing the good news, we can pray and expect Jesus to use us too. Jesus is waiting for our prayers, and also looks forward to telling our neighbors, family, and friends about Him. Dear friends, let's pray daily for our closest family, friends, and neighbors. Just as Jesus blessed Paul, He will also grant us wonderful fruits of evangelism. Let's offer our time and dreams to Jesus. Our Lord will guide us in the most amazing and fulfilling way.

"Jesus, please lead my life. I only pray. I love you, Jesus." When Jesus hears this prayer, He will be so happy and excited.

17. John saw heaven

My beloved friend. One of Jesus' disciples, John, got to see heaven. Jesus had a special love for John. When John was on the island of Patmos, Jesus showed him a vision of heaven. Jesus also told him about what will happen in the last days. He showed that when we die, we will face judgment before God's throne. We will either go to heaven or hell. If we believe in Jesus and live according to His will, we will go to heaven. But if we don't believe in Jesus, we will go to hell. In heaven, our names will be written in the Book of Life. Isn't that exciting, dear friends? When our names are written in the Book of Life and we enter heaven, there will be no sadness or evil, but only happiness and joy. Jesus has prepared a joyful home for us in heaven. Angels are building our homes in heaven when our friends pray, worship, and follow Jesus' commandments. Heaven is made of gold and precious jewels, and there is a tree of life. We must share the message with our family, friends, and neighbors so that we can all go to the joyful heaven together. Let's believe in Jesus and worship Him with all our hearts to go to heaven.

FEEDBACK

01

- a) Is there anything more important than Jesus in your life? What is it?
- b) Do you remember any moment that you`ve done wrong to Jesus? Share with us.

02

- a) Have you ever promised something to Jesus? What were those things?
- b) What can you change in your life to be truthful to Jesus?

03

- a) Is there anyone who likes to wash his/her feet? Why do you wash his/her feet?
- b) How do you like to share the love of Jesus to your dearest person?

04

- a) If Jesus wants to eat with me, what would you like to eat with Jesus?
- b) What makes you feel that you`ve been loved by Jesus these days?

05

- a) What do you do when you face an unfair situation?
- b) Jesus took a Cross to save us from sin. what kinds of sin do you have to repent to him?

06

a) Innocent Jesus took the pain on cross for us, what kinds of pain are you gaining for Jesus?

(Ex. sharing gospel to my hatest friend, going to church when my family against it)

b) What would you like to say to Jesus who took a cross for you?

07

a) Who led you to Jesus? How has your life changed after accepting Jesus?

b) As the thief sincerely asked Jesus, what do you sincerely ask to him now?

08

a) Do you think you`ve been saved by Jesus? What makes you think about it?

b) How will you like to share the gospel of Jesus? How will you prepare for it?

09

a) If you could meet Jesus after his resurrection, what would you like to talk about with him?

b) Do you believe that we are surrounded by angels? How do you feel about it?

10

a) If you meet Jesus like his disciples, which part of his body do you like to touch to know he is alive?

b) If Jesus visit your house, what would you like to serve to Jesus?

11

a) If Jesus asked you "Do you love me?" just as he did to Simon, How will you answer him?

b) What do you like to do for Jesus when you grow up?

12

- a) Let`s think about each one`s faith, how can grade your faith to Jesus?
- b) Do you pray and praise the Lord everyday at home? if not let's start doing it today.

13

- a) What kinds of promise on faith do you like to tell to Jesus?
- b) If you go to heaven and face Jesus, what praise will Jesus give it to you?

14

- a) Let`s share the answered prayers that you desperately asked to Jesus.
- b) Let`s think who needs you to pray for him or her.

15

- a) Can you carry on as Stephen when you get bullied by sharing the gospel?
- b) What inspires you from Stephen`s life to share the gospel?

16

- a) As Paul had completely changed in his life, do you have any bad habit or history which has been changed by believing in Jesus?
- b) Where do you like to visit to share the gospel? (country or community)

17

- a) Where do you like to visit first with Jesus, when you go to heaven?
- b) List up the things that you have to do for all your family to go to heaven with you.

ACTIVITIES AND GAMES

1. send away the bad heart

Make a caterpillar and write my evil heart. and jumping it away from you.

2. paper cup memory game

make 2 sets of 5 numbered paper-cups and play a memory game.

3. paper cup plane

As Jesus washed disciples` feet, let's also pray for others. Our prayers will go high as the plane.

4. stand with one foot game

the group will hold each other's hand, everyone will stand with just one foot at one time.

We should have one cooperative heart in Jesus.

5. Moving Octopus

We should follow Jesus as this moving octopus moves.

6. Memorizing bible verse in relay

We always have to remember the words of God and grace of the cross

7. Balloon anklet

Tied one balloon on ankle

8. Rabbit-suncap

Make a rabbit-suncap and wear it. play a jumping race. Let's run to Jesus just as the rabbit.

9. Moving UFO

Making UFO with paper-plate. Seeing UFO moving up, remember we`ll also go up when Jesus calls us

10. Touch and Grab game

Touch your head and shoulder, and clap to start the race. Jesus showed and allowed people to touch him to believe his revival.

11. Chick race

Fold a chick and clap or blow to reach Jesus. We always have to just walk to Jesus.

12. Paper-cup soccer game

Let's think to whom we like to share the gospel. And as we blow the ball to shoot in the cup, let's share the good news to them.

13. Spinning top

Make a spinning top with paper-cup and straw. Let's wait for our ascended Jesus to come down for us.

14. Balloon Race

Balloon race with one foot going, both feet returning. Remember what disciples had done with their faith.

15. Making a heavenly crown

Just as Stephen received the crown at heaven, let`s also receive a beautiful crown from Jesus by sharing the Gospel to others.

16. Blindfold game

As Paul opened his eyes by meeting Jesus, Let's also just follow Jesus` voice in our life.

17. Paper ice cream

Fold two papers to make an ice cream. Let's imagine what will be in heaven.

COLORING ACTIVITY

1. Judas Iscariot who betrayed Jesus
The scriptures must be fulfilled (Mark 14. 49)



2. Lies

Then Peter remembered the
word Jesus had spoken to him
(Mark 14:72)

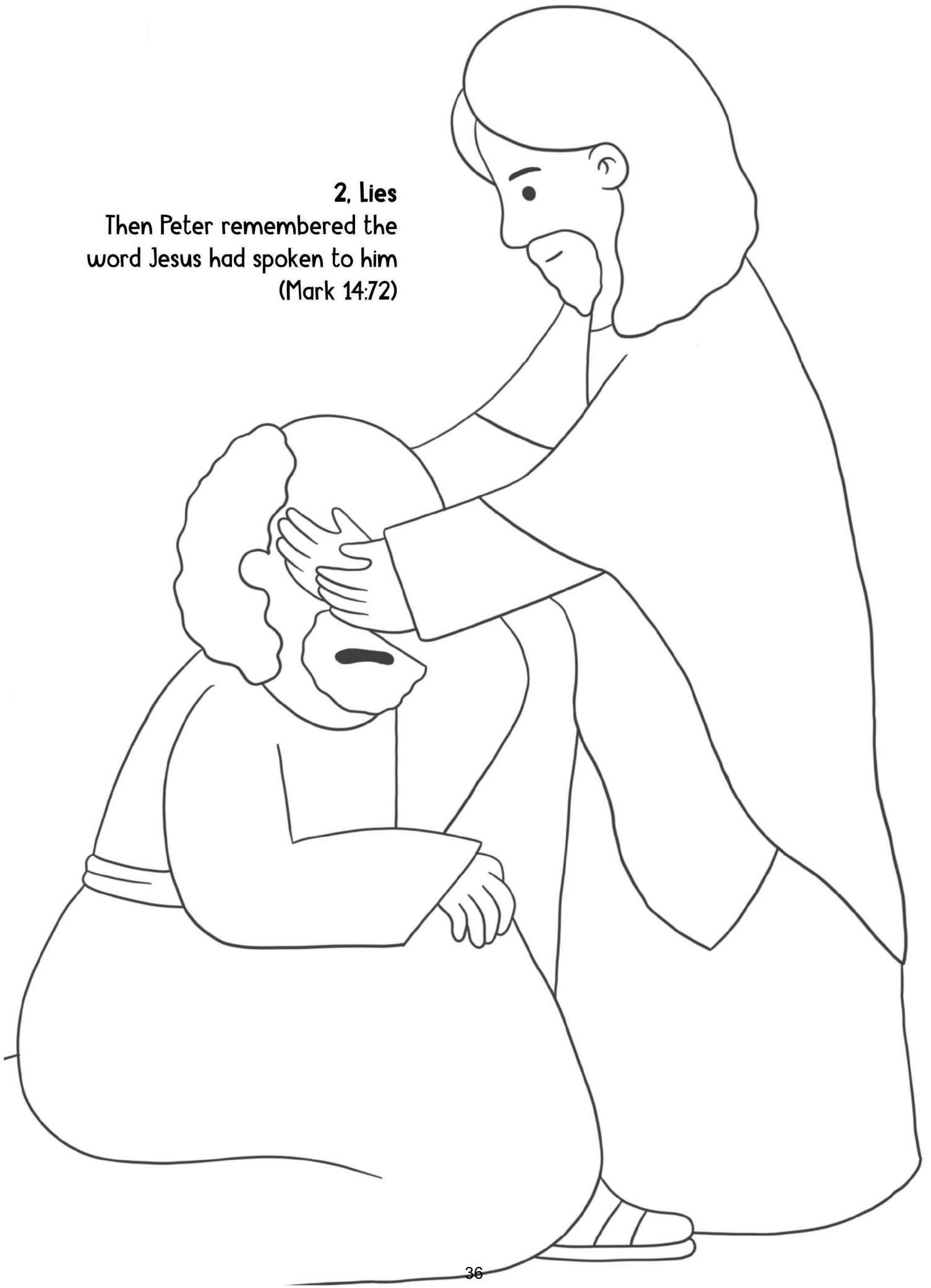

3. Jesus washing his disciple's feet

As I have loved you so you must love
one another.

(John 13:34)

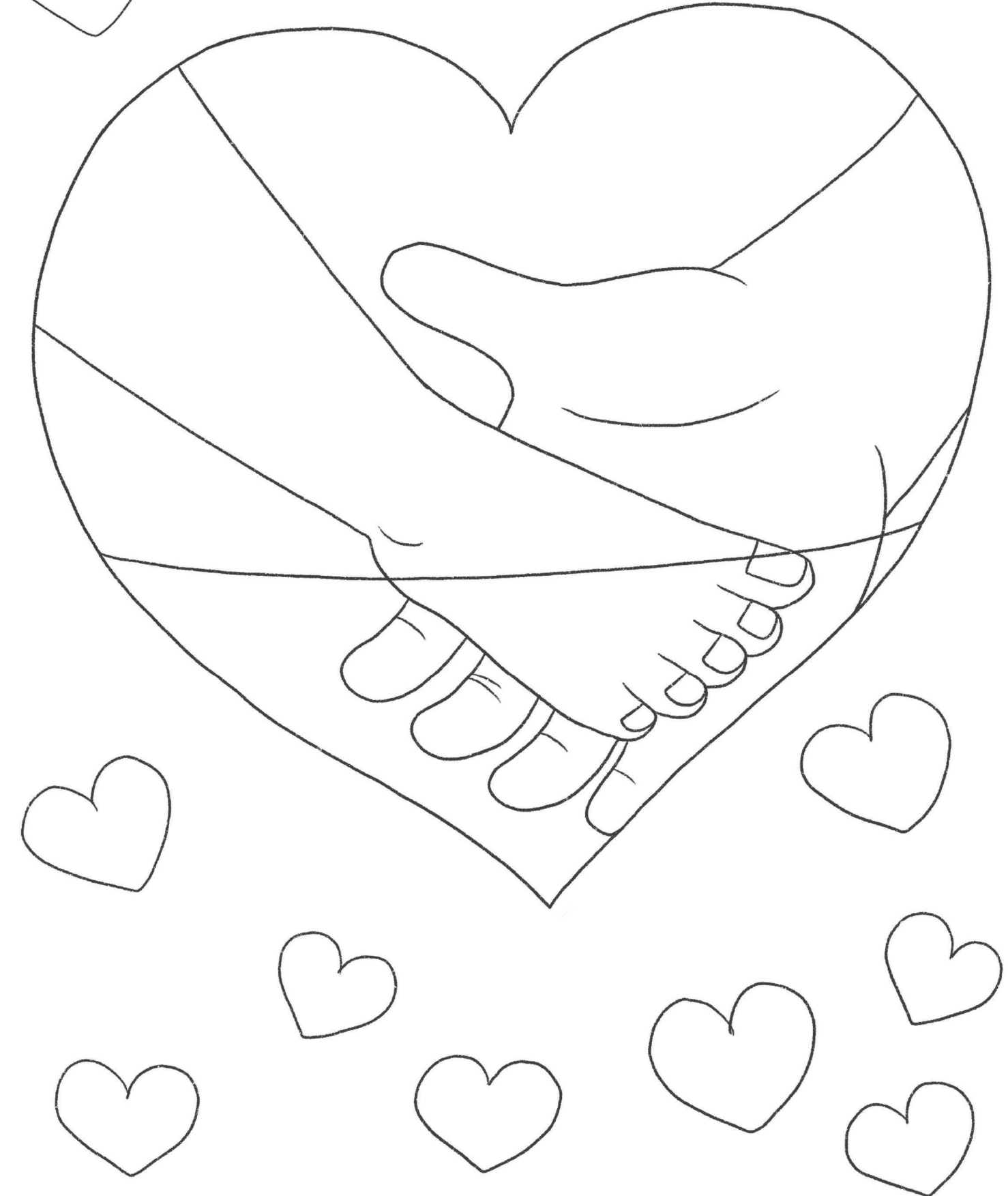

4. Last dinner with Jesus

You proclaim the Lord's death until he comes

(1 Corinthians 11:26)

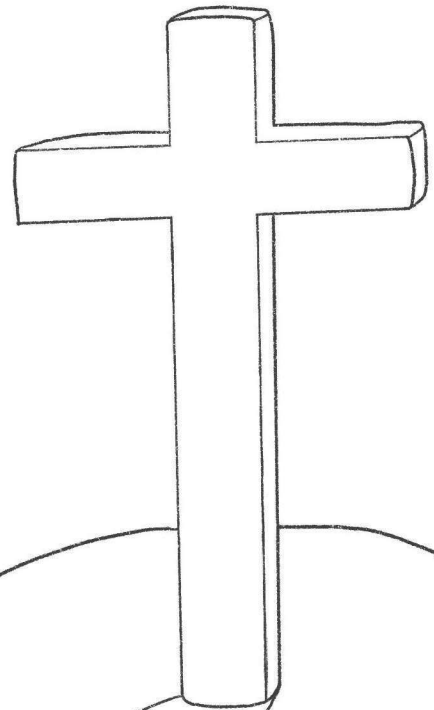

5. THE TRIAL OF JESUS

Everyone on the side of truth listens to me

(John 18:37)



6. JESUS IS NAILED TO A CROSS

Jesus of Nazareth, The King of the Jews

(John 19:19)

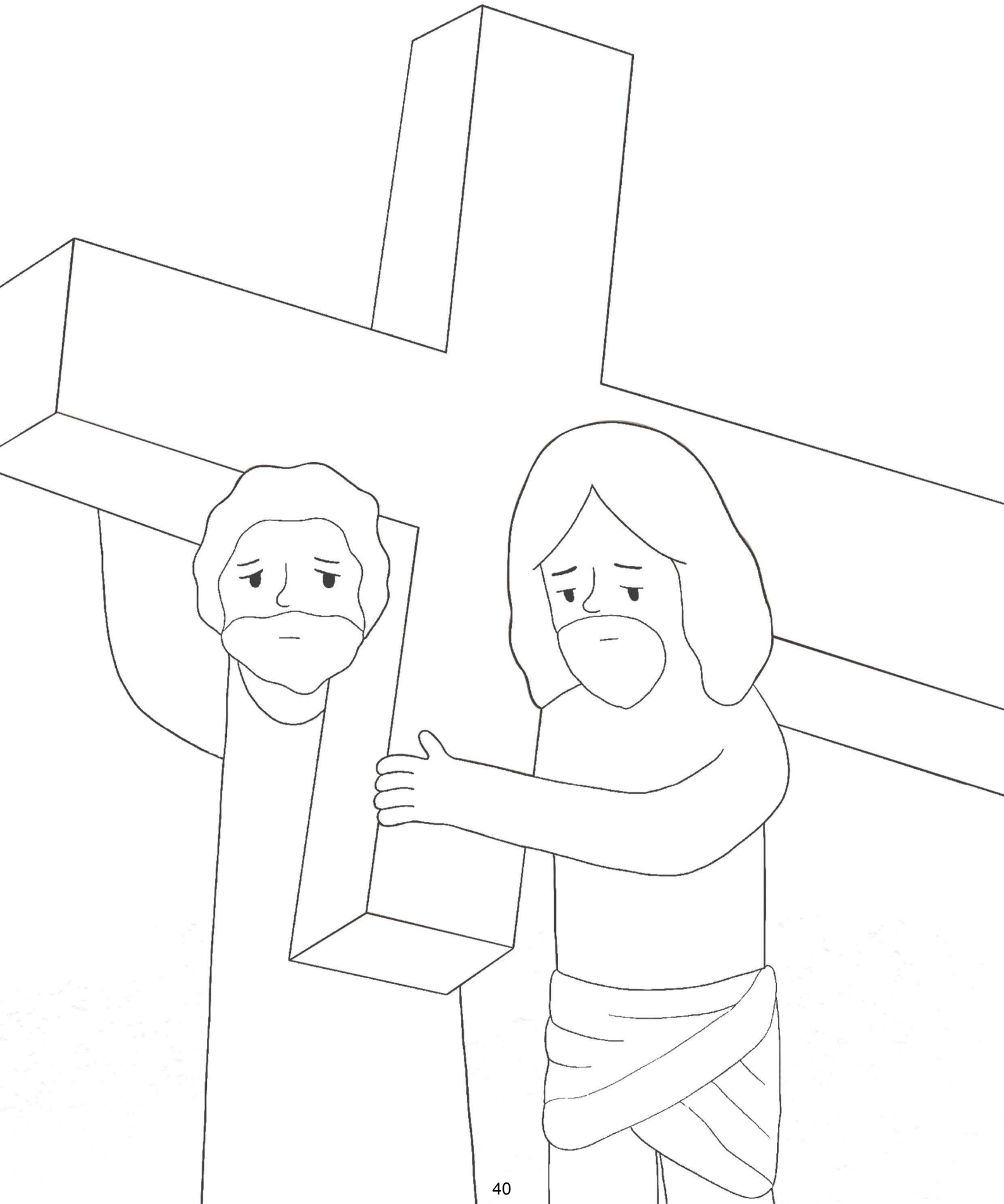

7. THE THIEF ON THE CROSS WAS SAVED

Today you will be with me in paradise

(Luke 23:43)



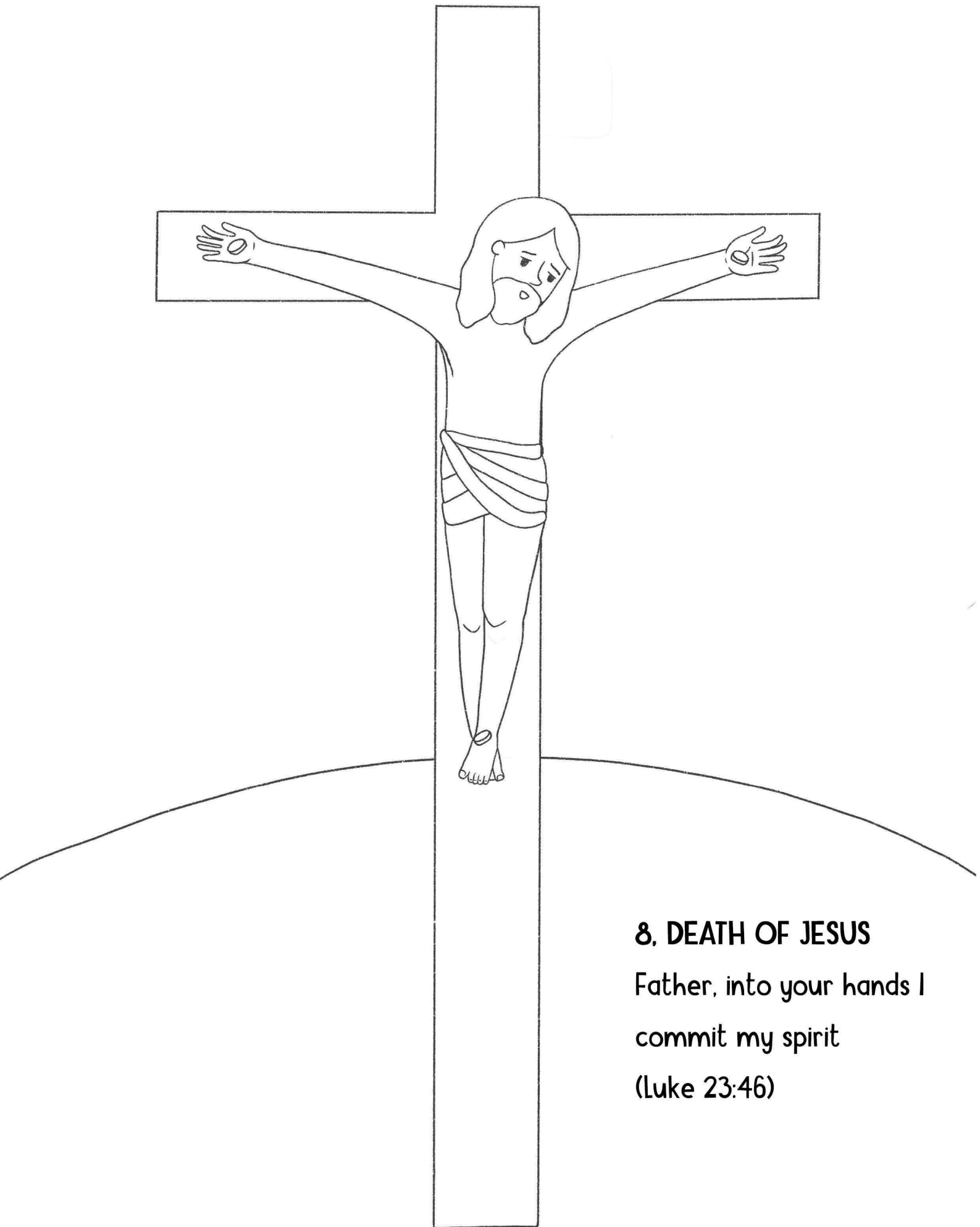

8, DEATH OF JESUS

Father, into your hands I
commit my spirit
(Luke 23:46)

9. JESUS HAS RISEN!

Be crucified and on the
third day be raised again.

(Luke 24.7)

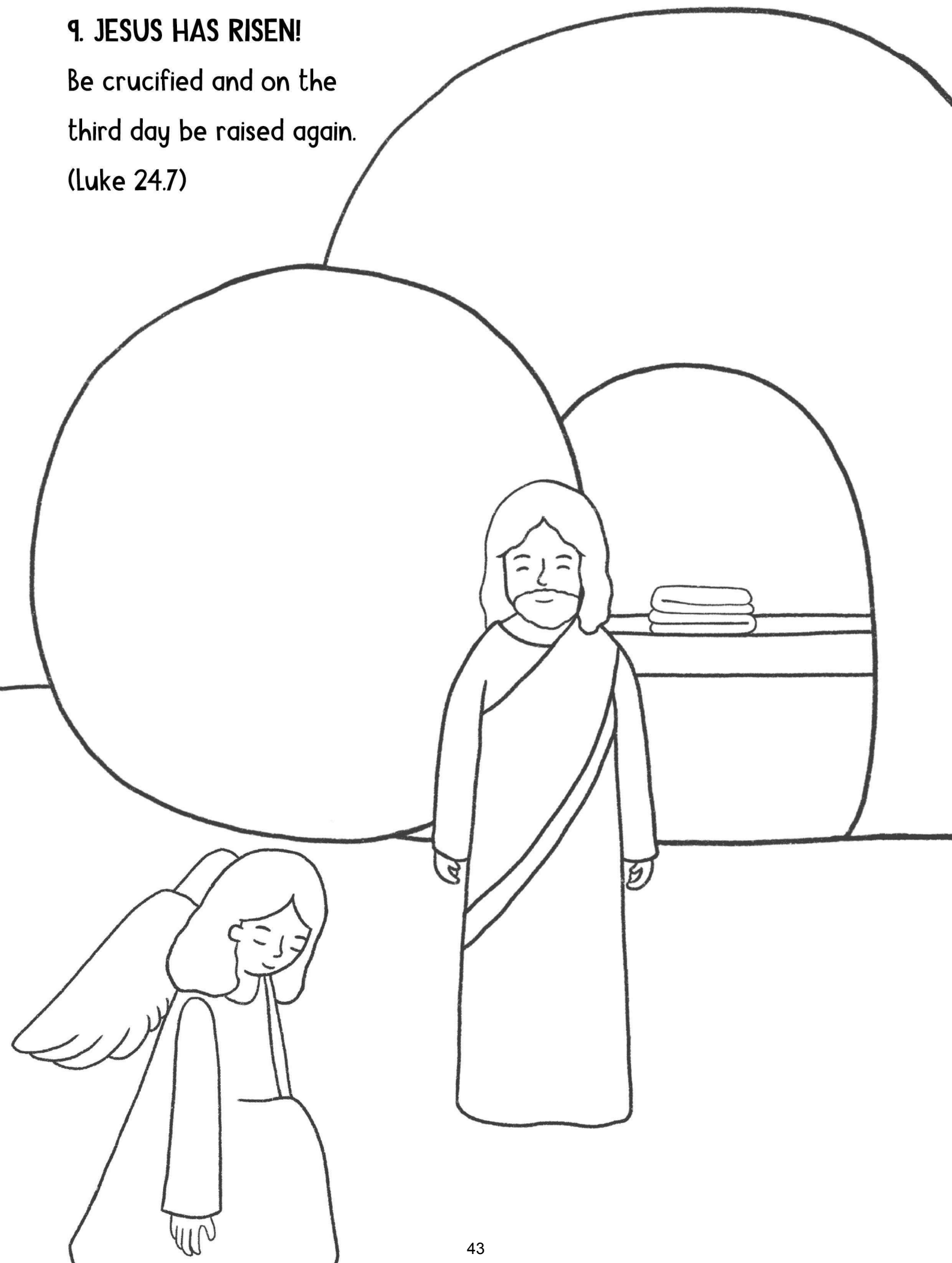

10. TOUCH ME AND SEE

Look at my hands and
my feet. It is I myself!

Touch me and see

(Luke 24:39)



11. PETER'S CONFESSION

Do you love me more than these?
Yes, Lord, you know that I love you.
(John 21:15)



12. WHAT WE MUST DO

You proclaim the Lord's death until he comes

(1 Corinthians 11:26)

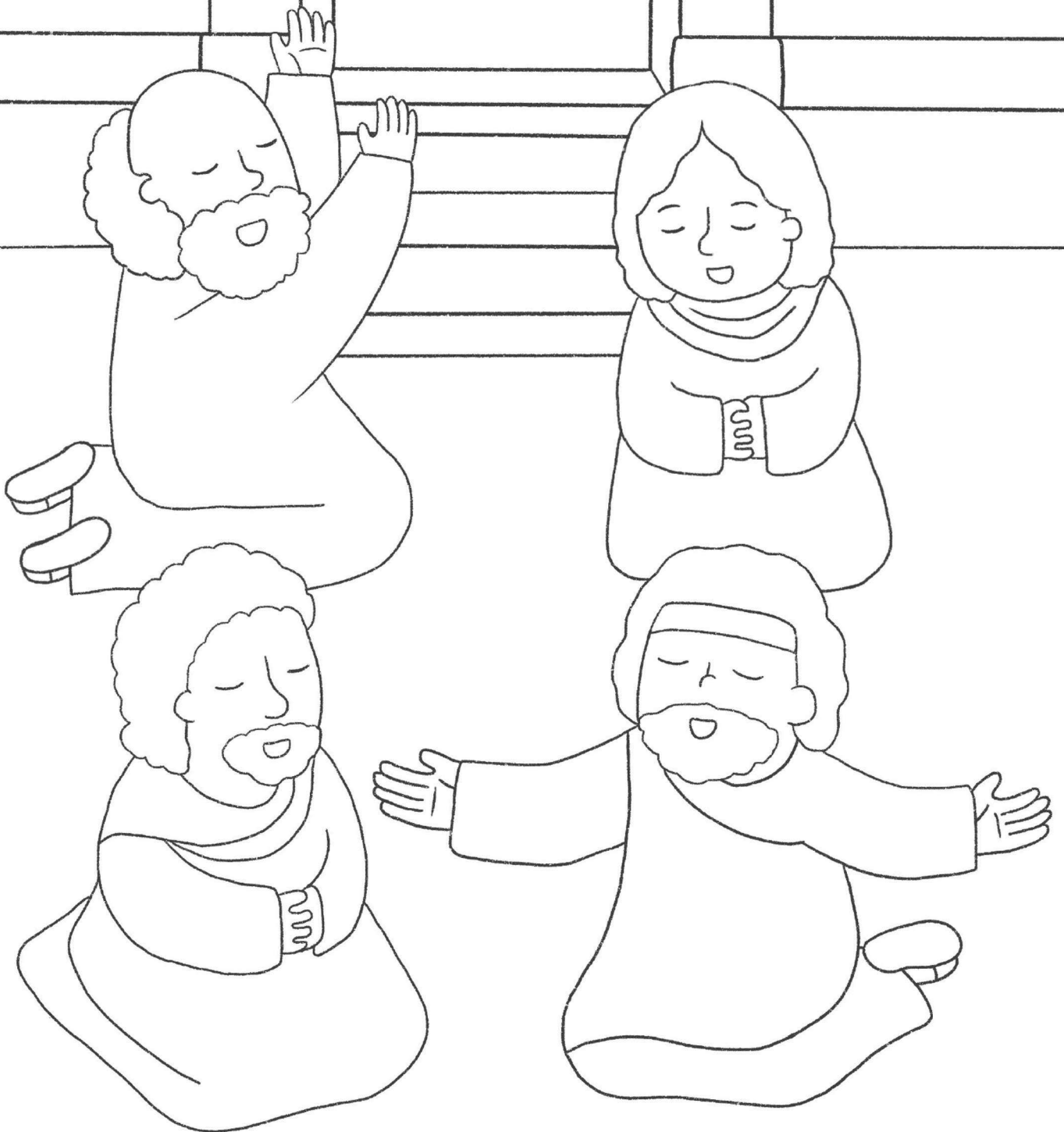

13. JESUS WILL COME LIKE JUST HE WENT INTO HEAVEN

Jesus will come back in the same way you have seen him go into heaven
(Act 1:11)

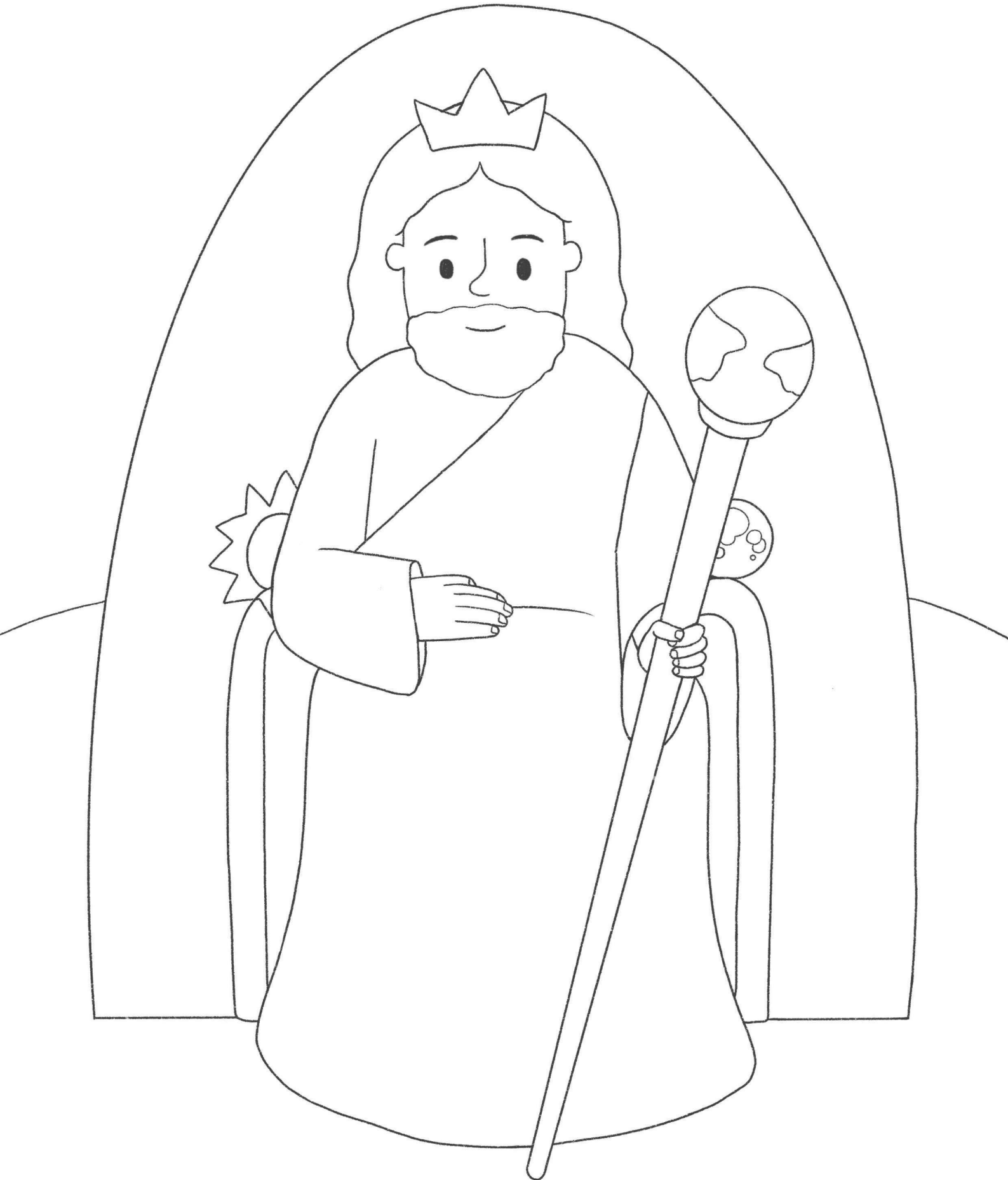

**14. PETER AND JOHN
HEALED A LAME MAN**

Silver or gold I do not
have, but in the name of
Jesus Christ of Nazareth,
walk. (Act 3:6)

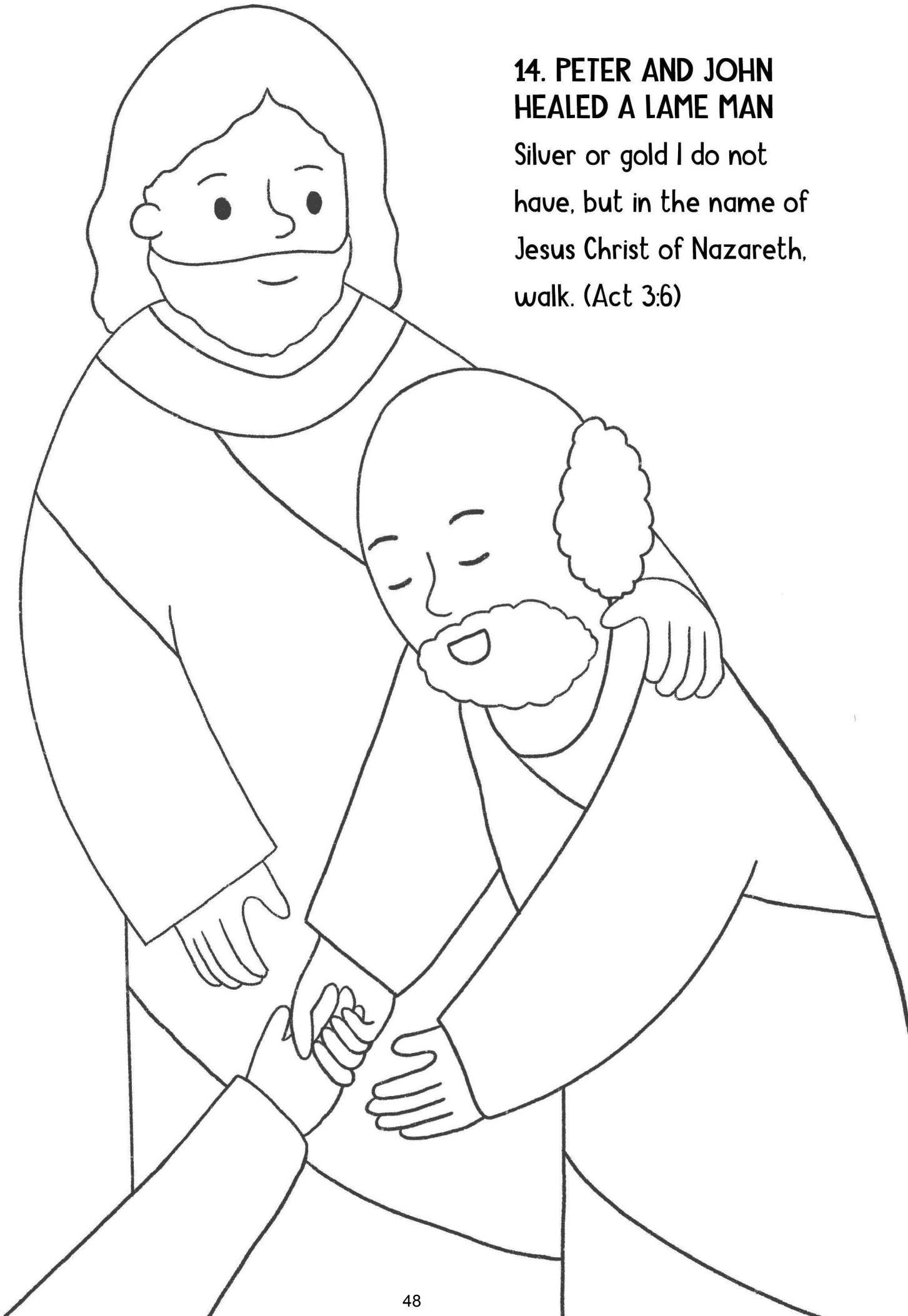

**15. STEPHEN WAS
STONED TO DEATH**

'Lord, do not hold this sin
against them'

(Act 7:60)

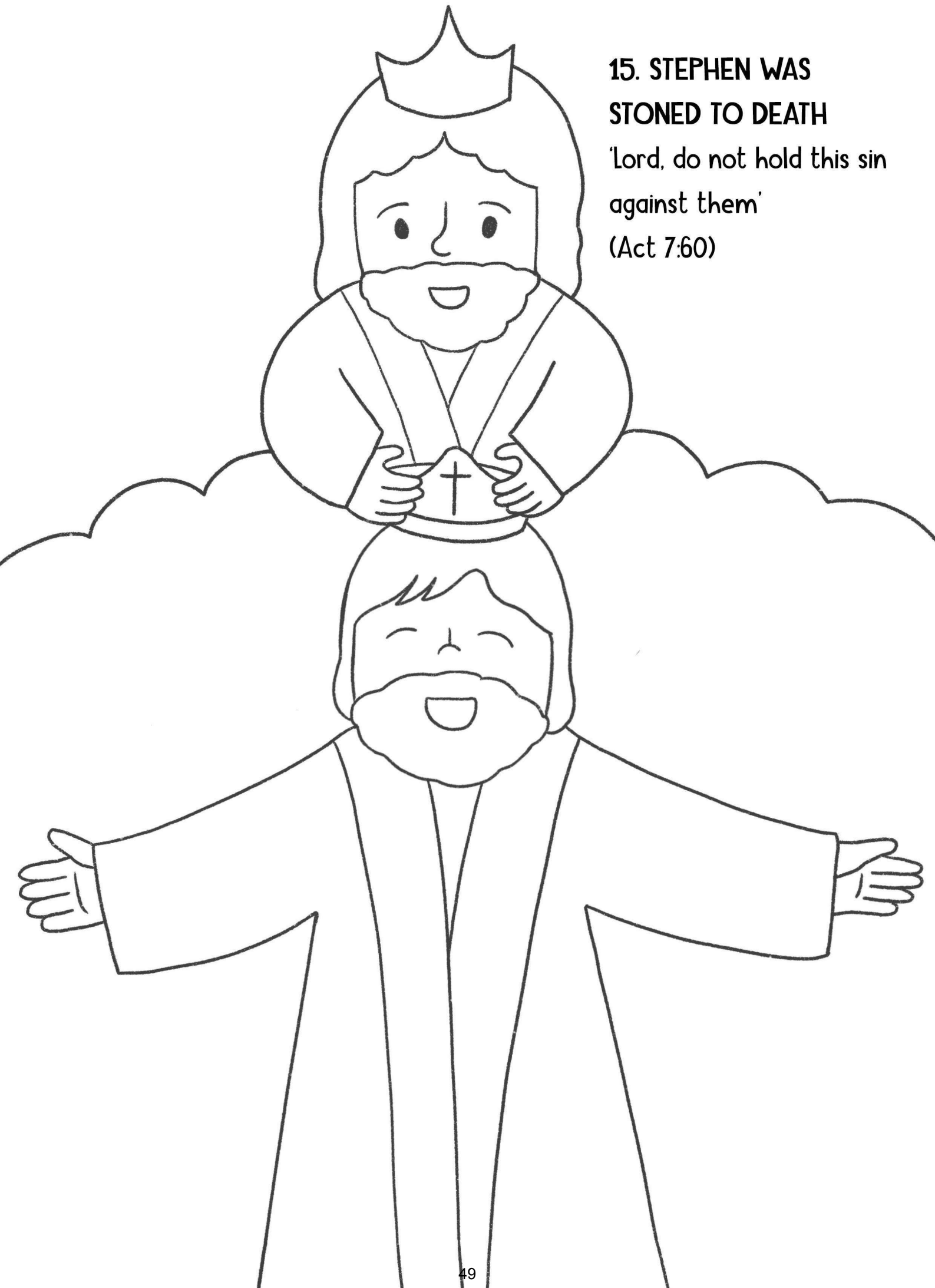

16. SAUL BECAME PAUL

By the Holy Spirit, it
grew in numbers living in
the fear of the Lord
(Act 9:31)

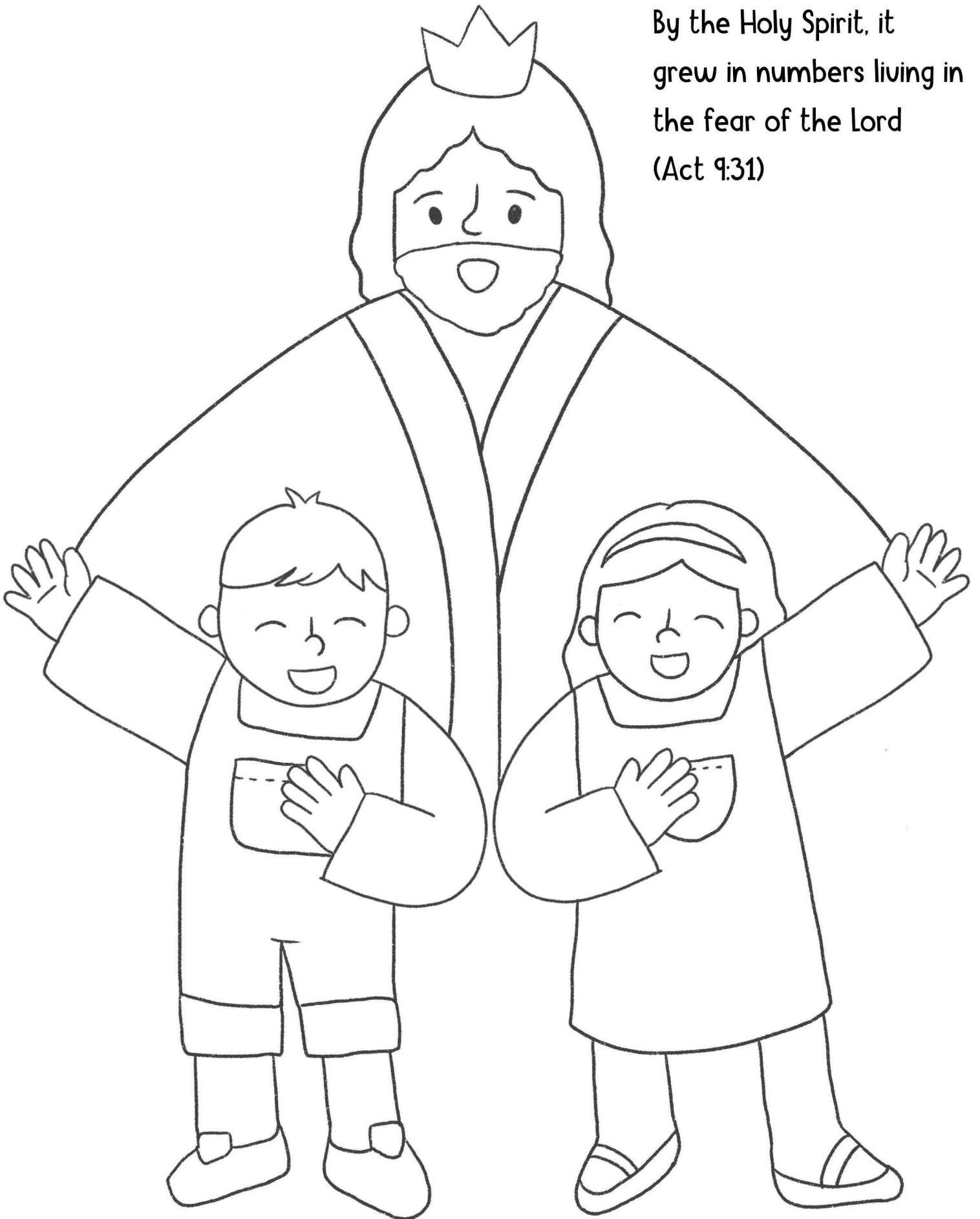

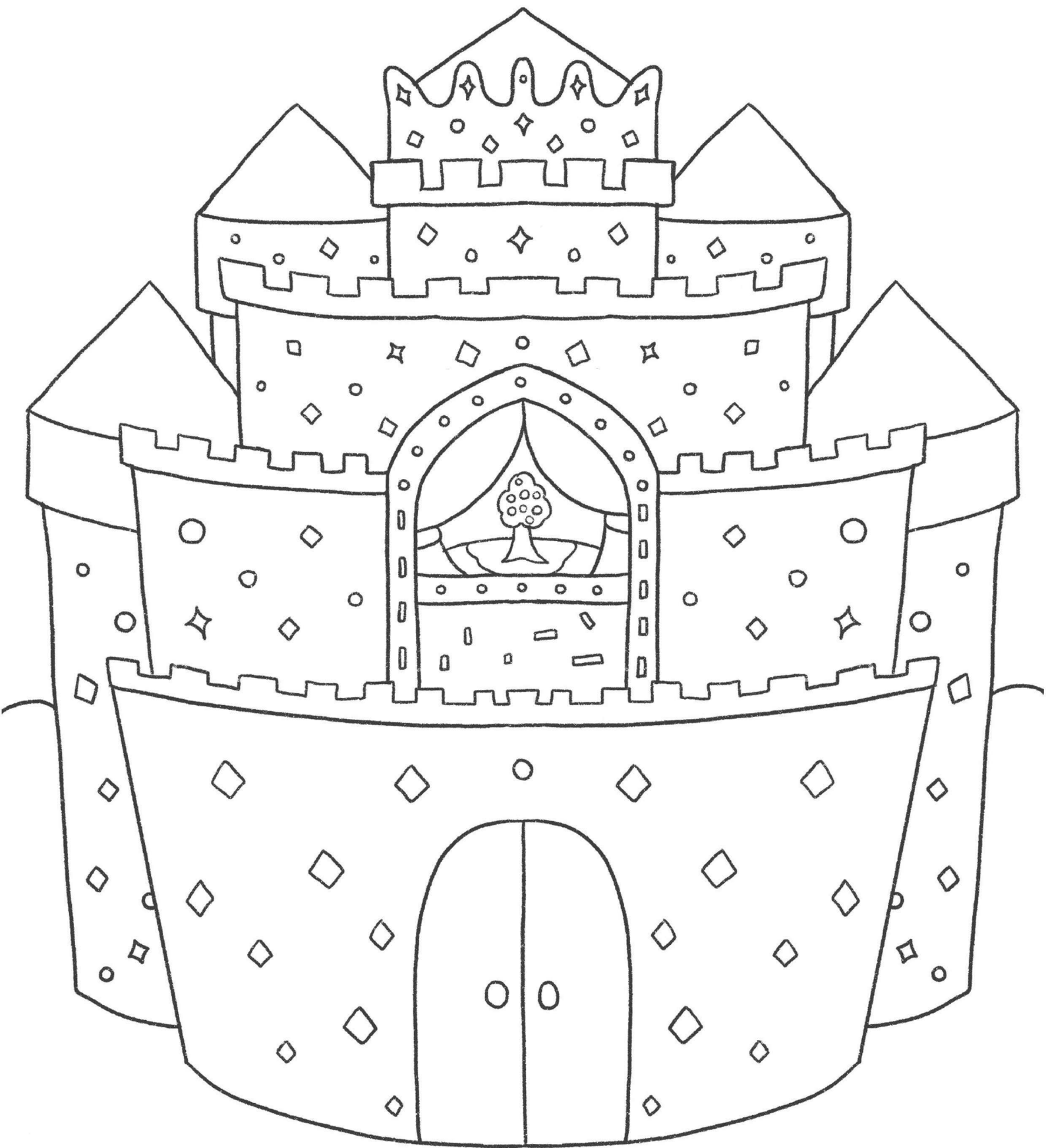

17. JOHN SAW HEAVEN

Behold, I am coming soon! Blessed is he who keeps
the words of the prophecy in this book
(Rev 22:7)

COLORING ACTIVITY

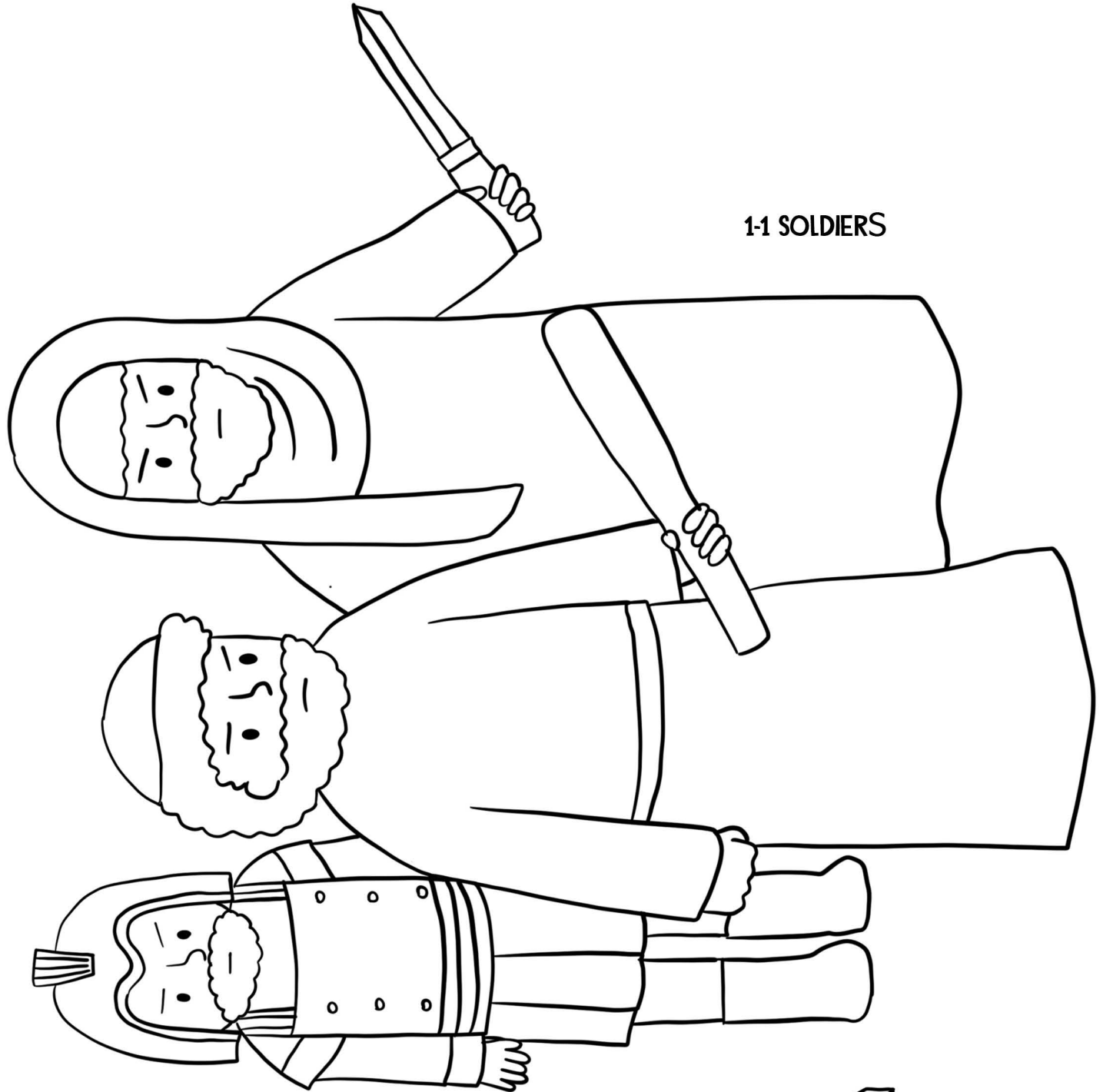

1-1 SOLDIERS

1-2 PETER



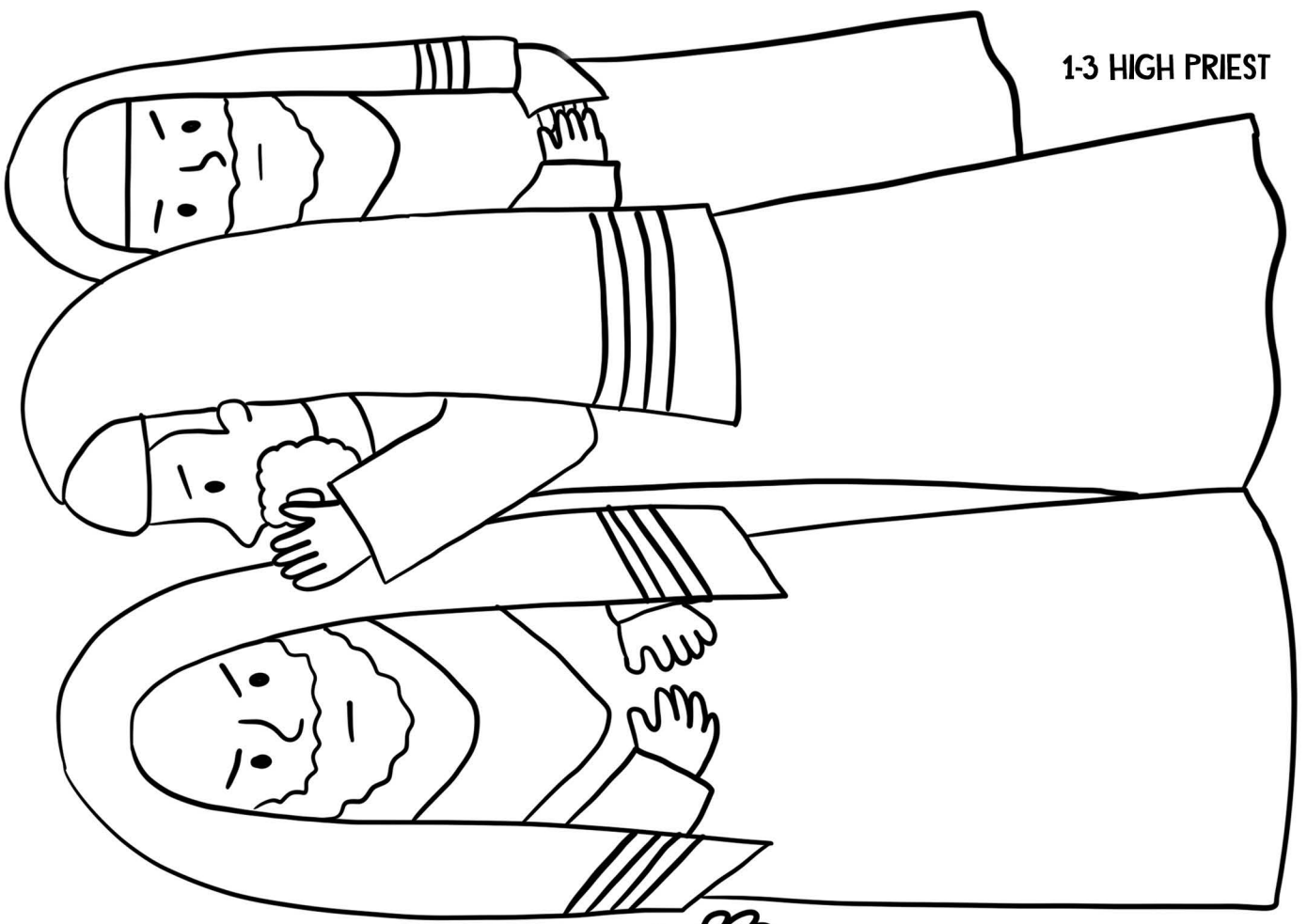

1-3 HIGH PRIEST

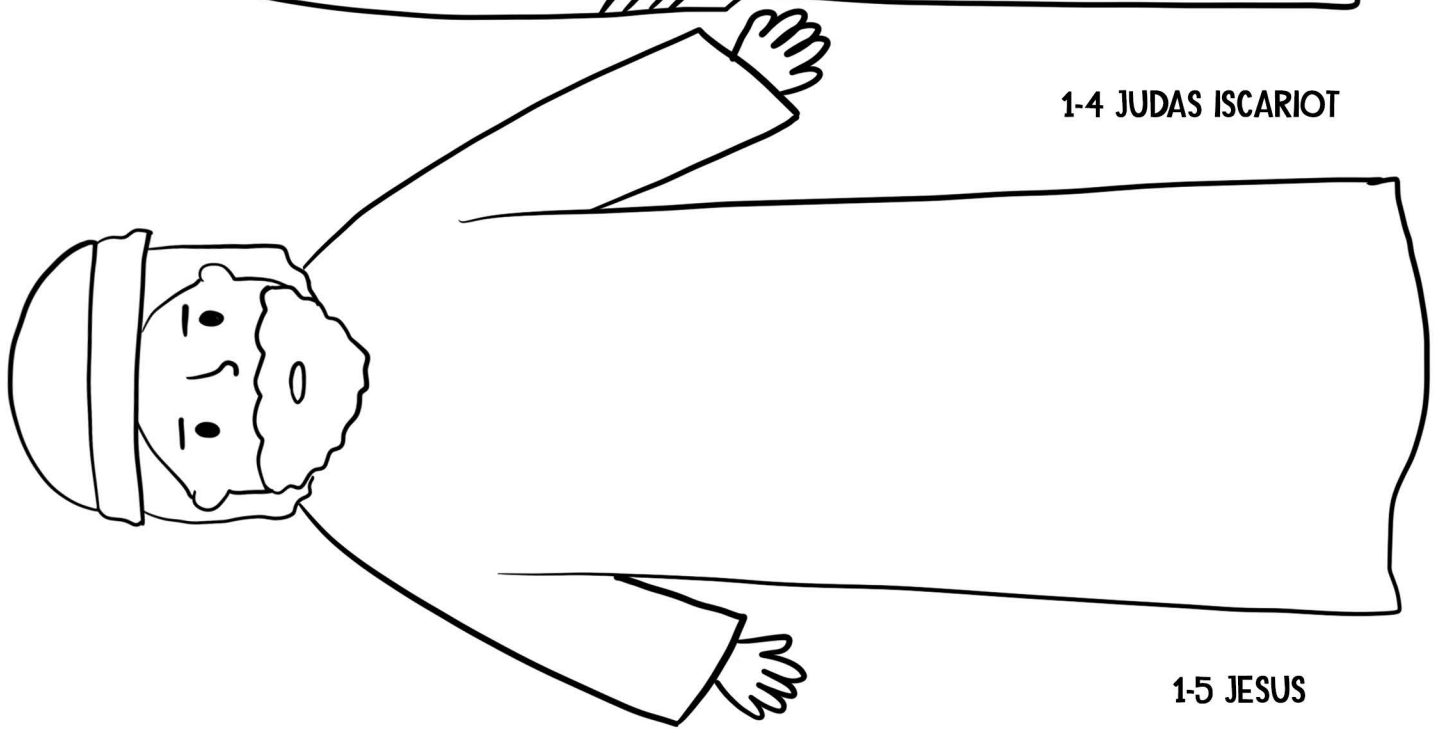

1-4 JUDAS ISCARIOT

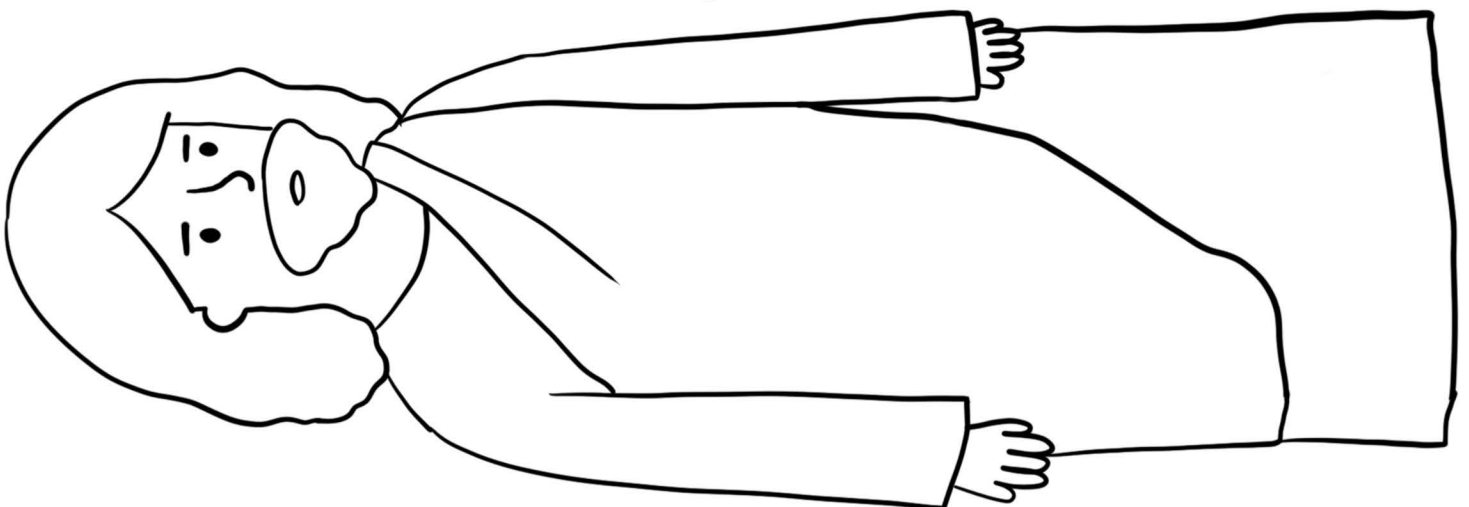

1-5 JESUS

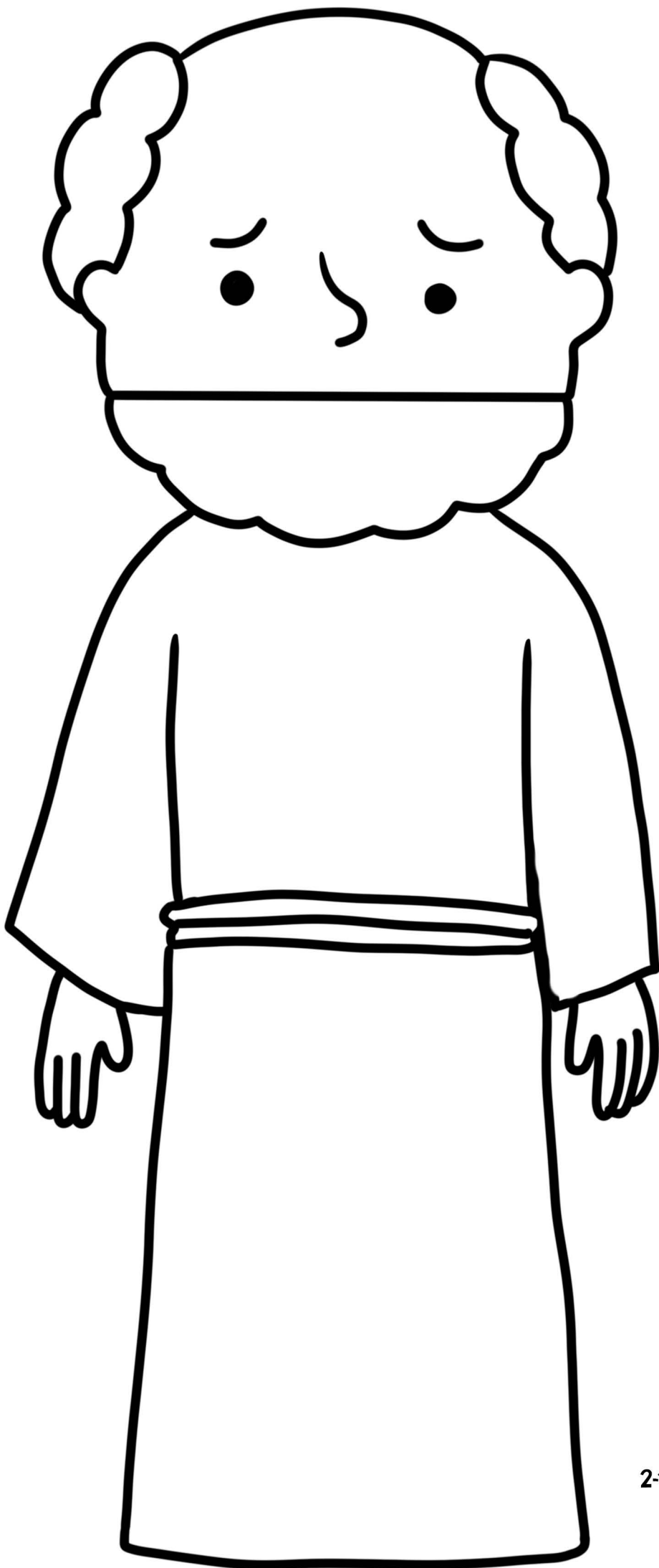

2-1 PETER



2-2 PERSON

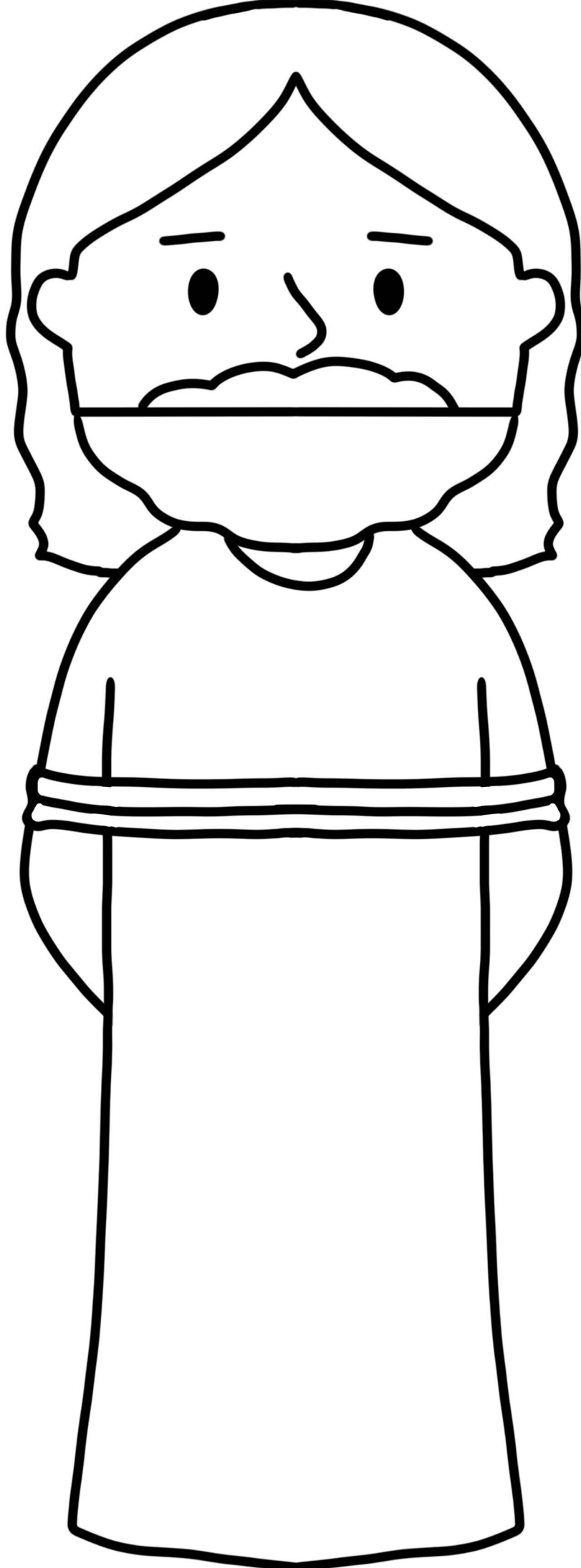

2-3 JESUS

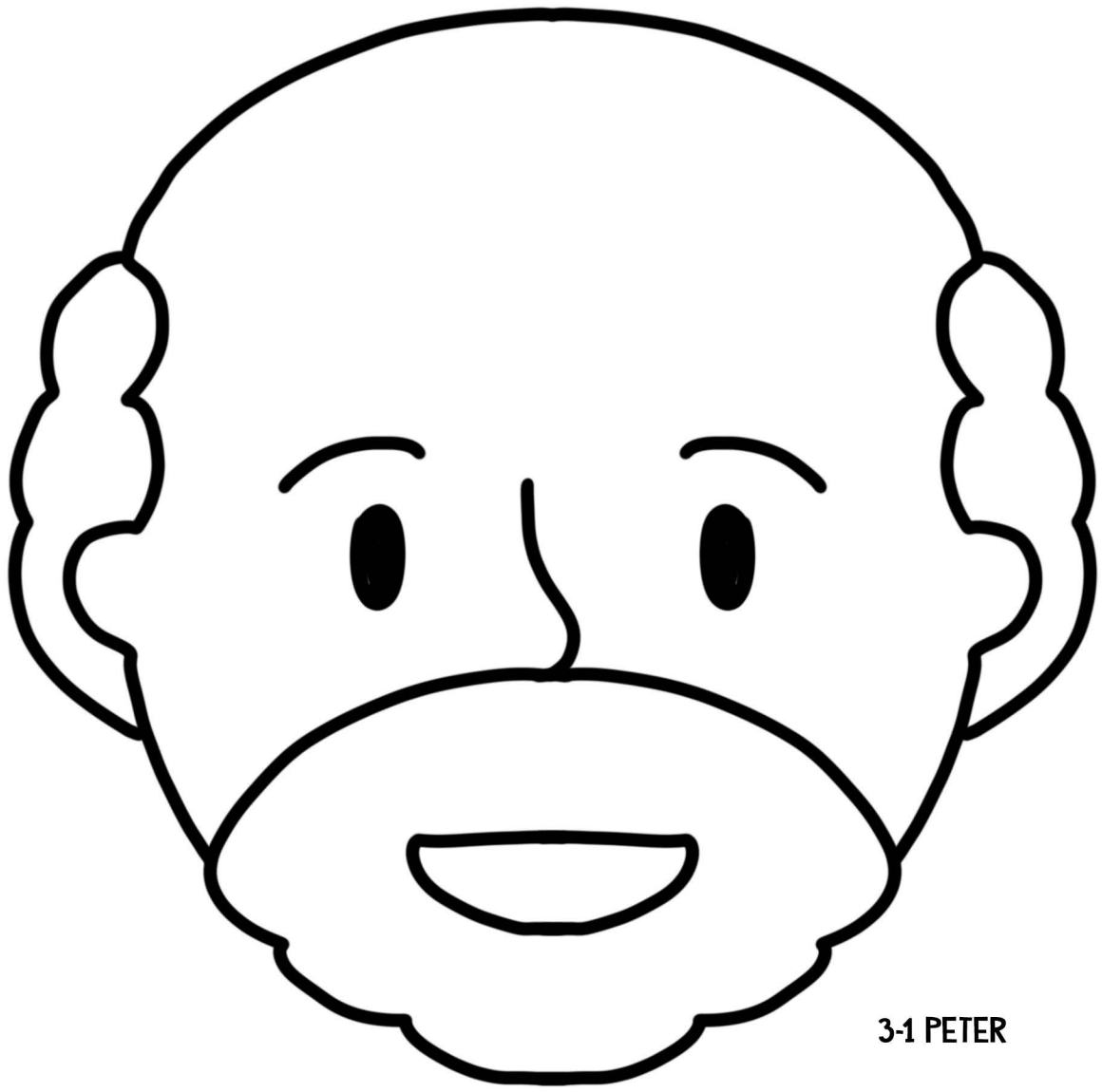

3-1 PETER

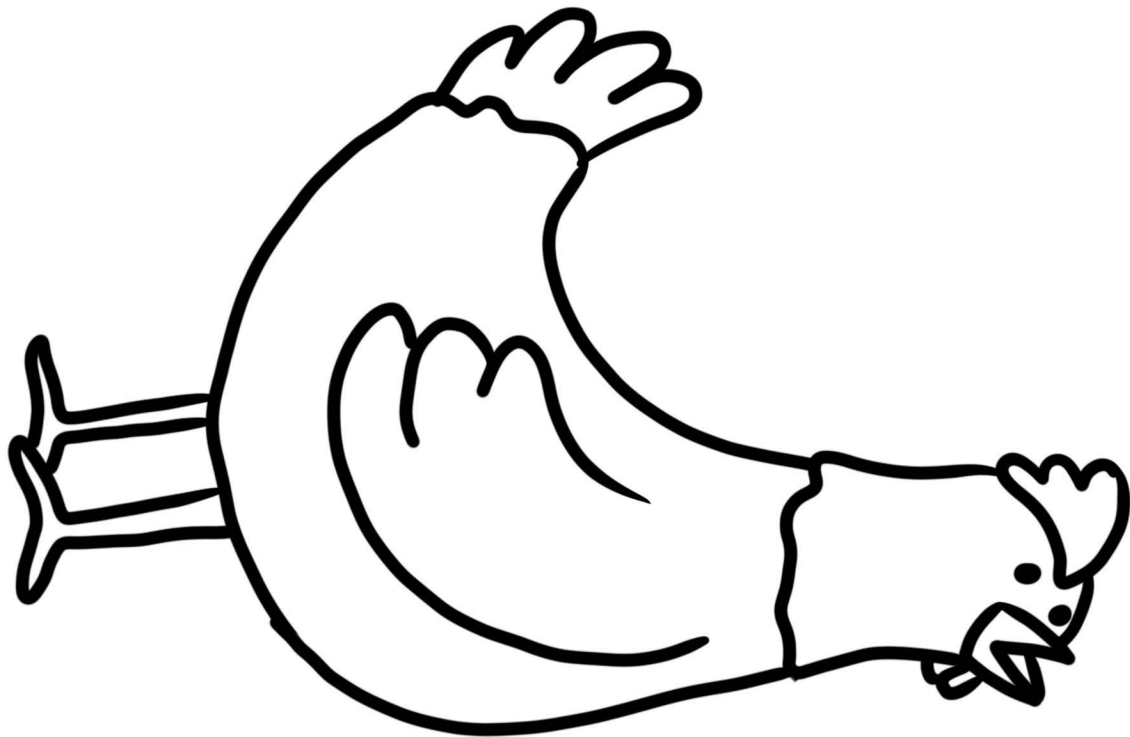

2-4 ROOSTER

3-2 JESUS

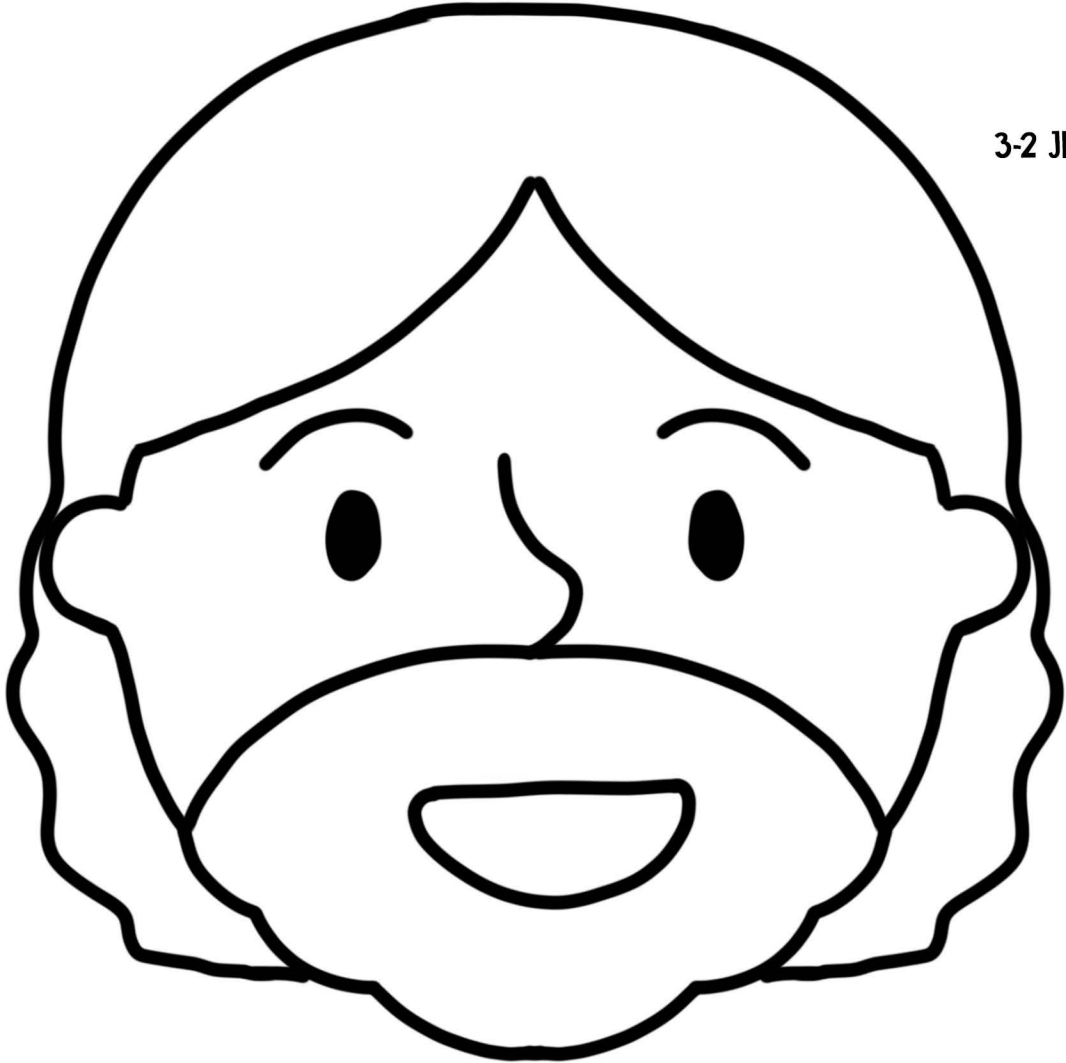

3-3 DISCIPLE

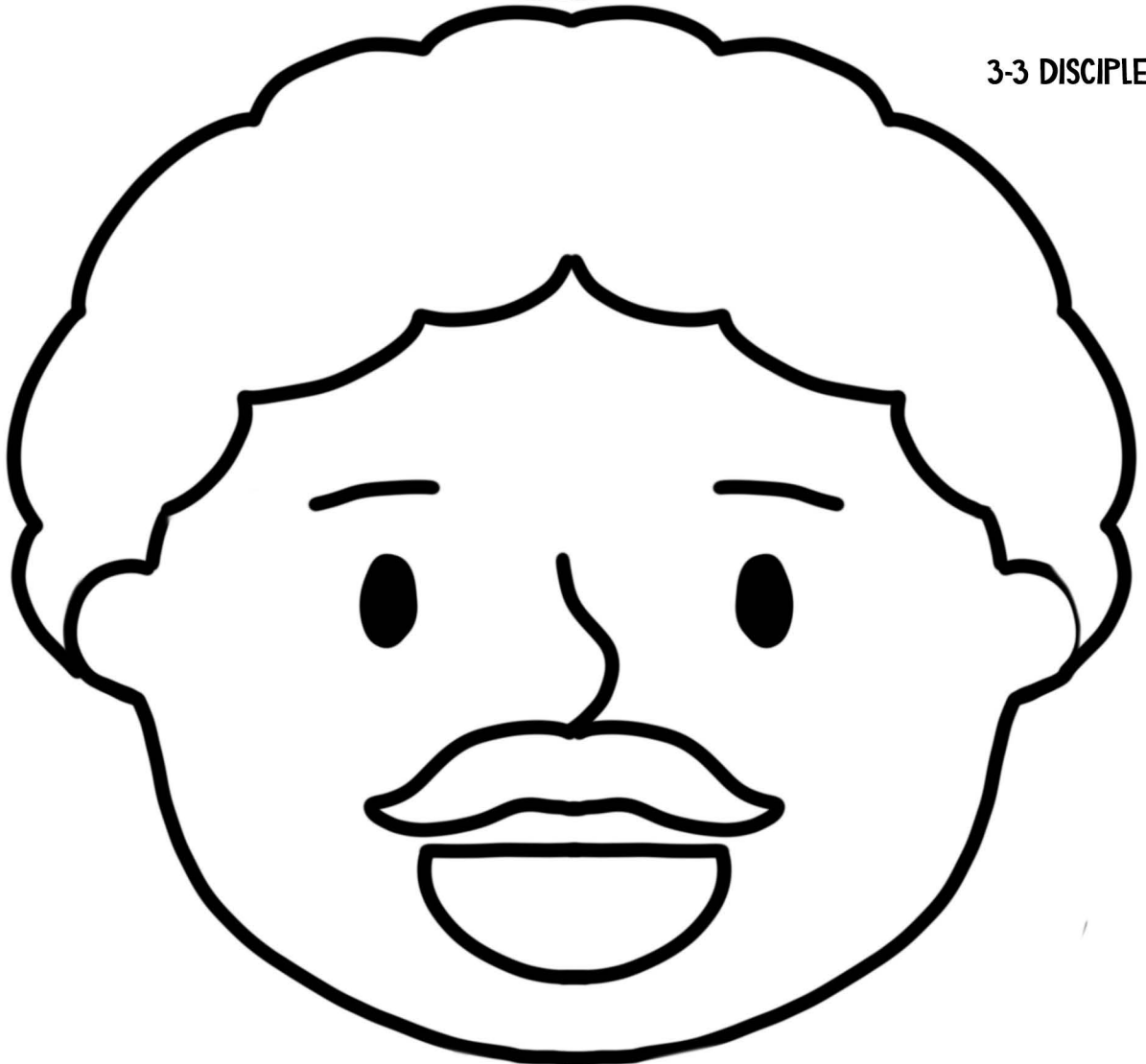

4-1 JOHN



4-2 JUDAS ISCARIOT



4-3 BREAD

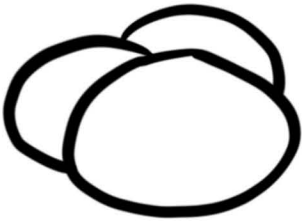

4-4 GLASS

4-5 PETER



4-6 JESUS





5-1 PONTIUS PILATE

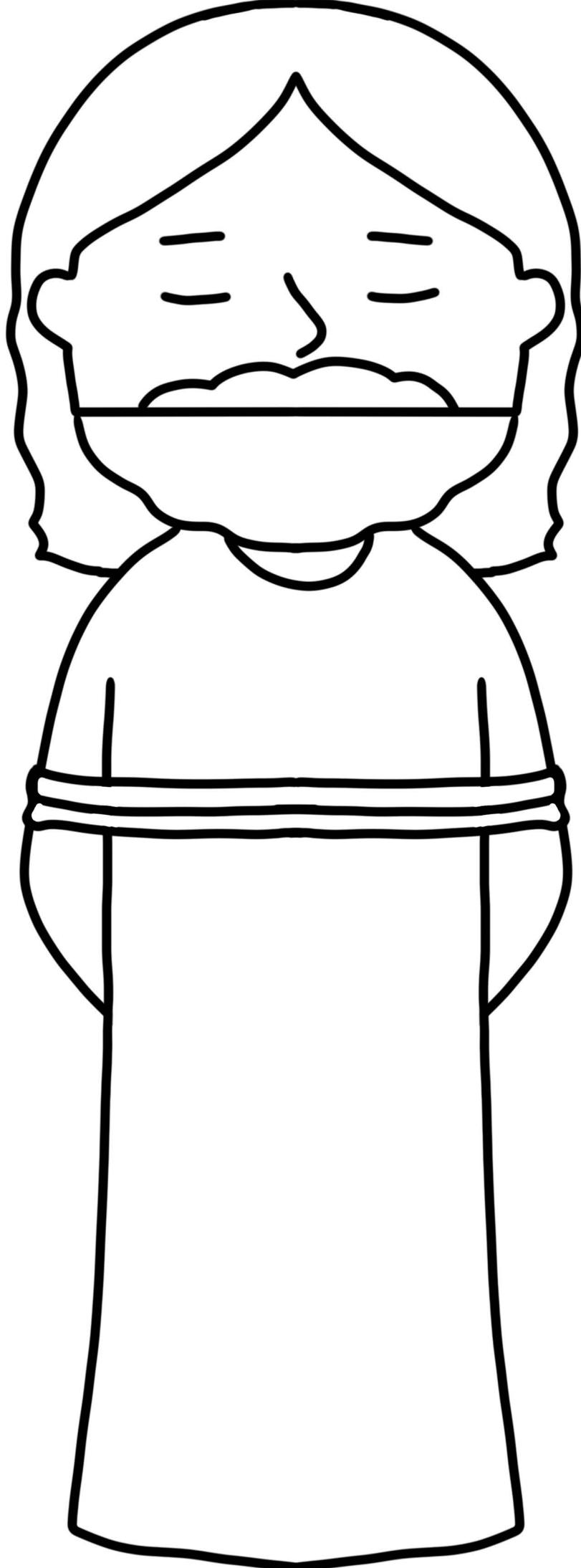

5-2 JESUS

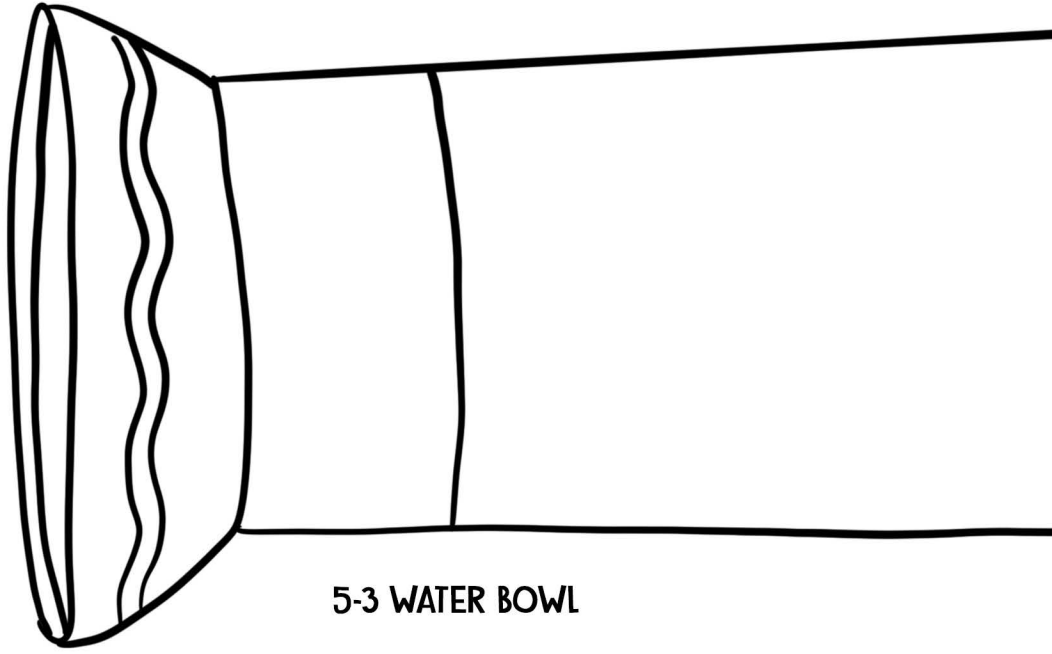

5-3 WATER BOWL

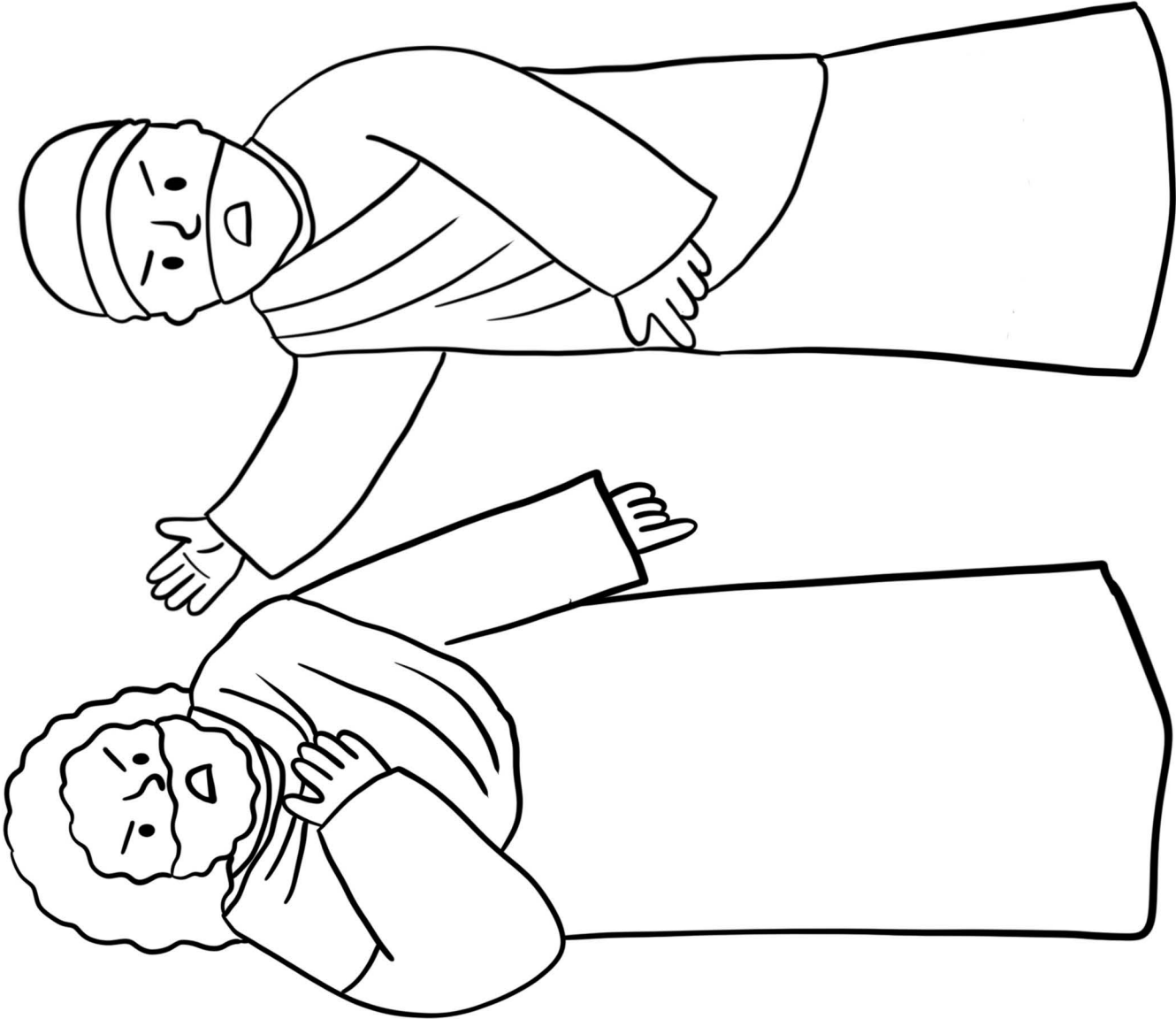

5-4 PEOPLES

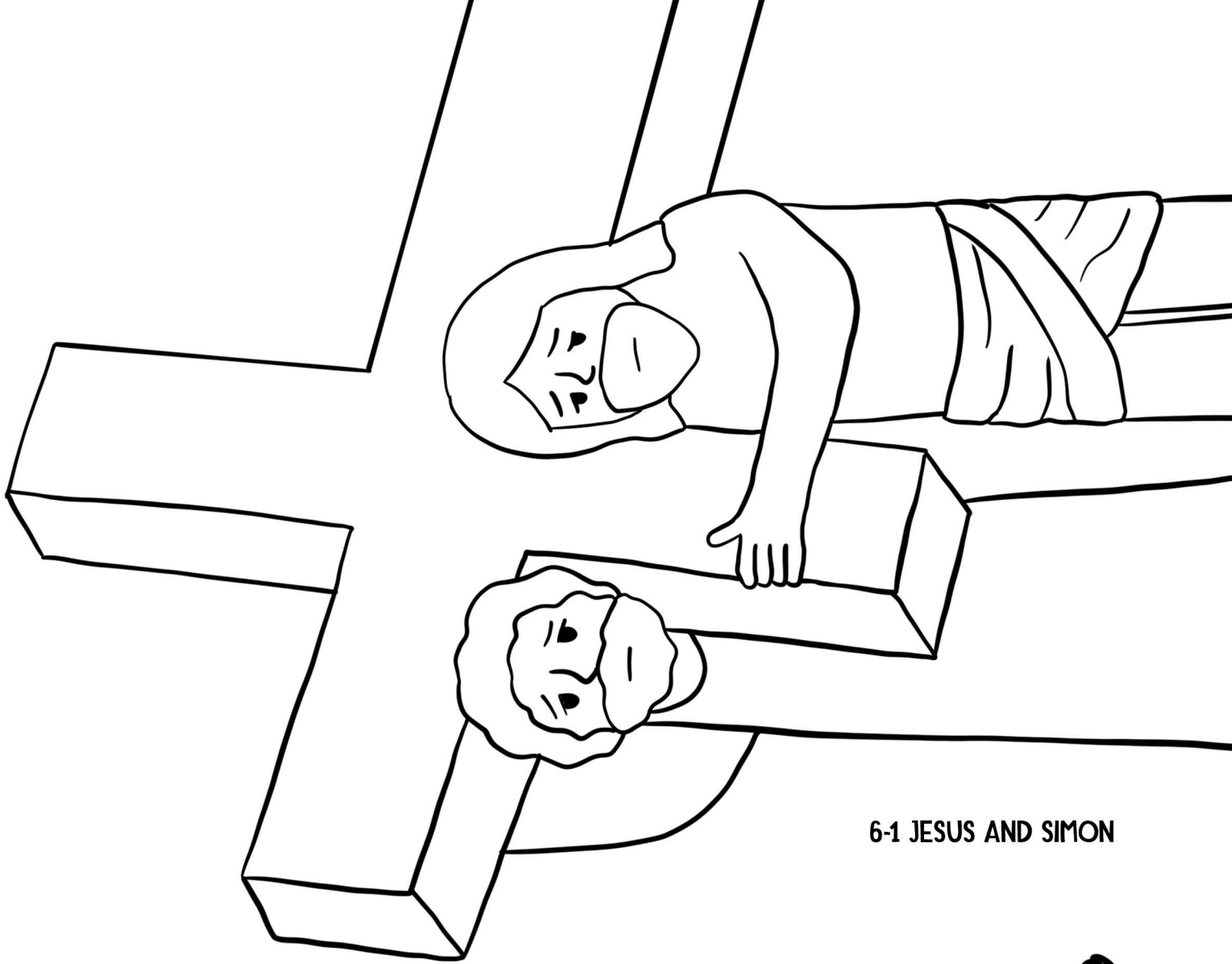

6-1 JESUS AND SIMON



6-2 SOLDIER

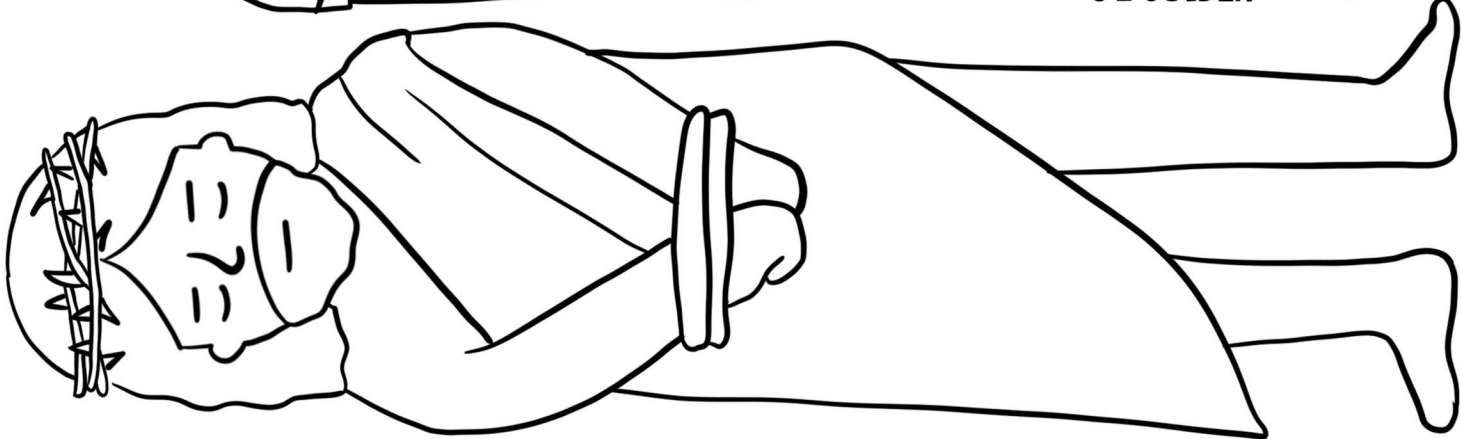

6-3 JESUS

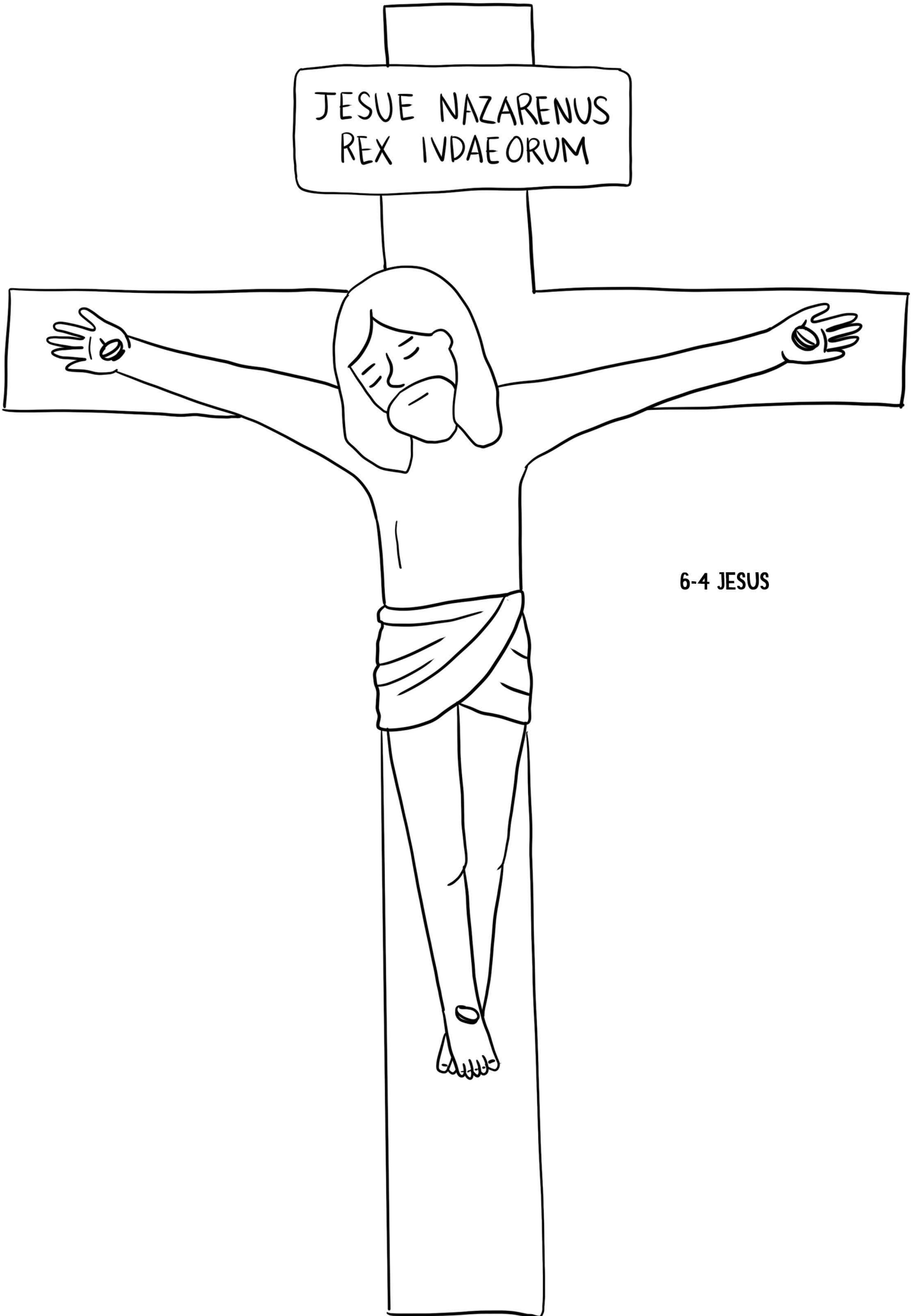

6-4 JESUS

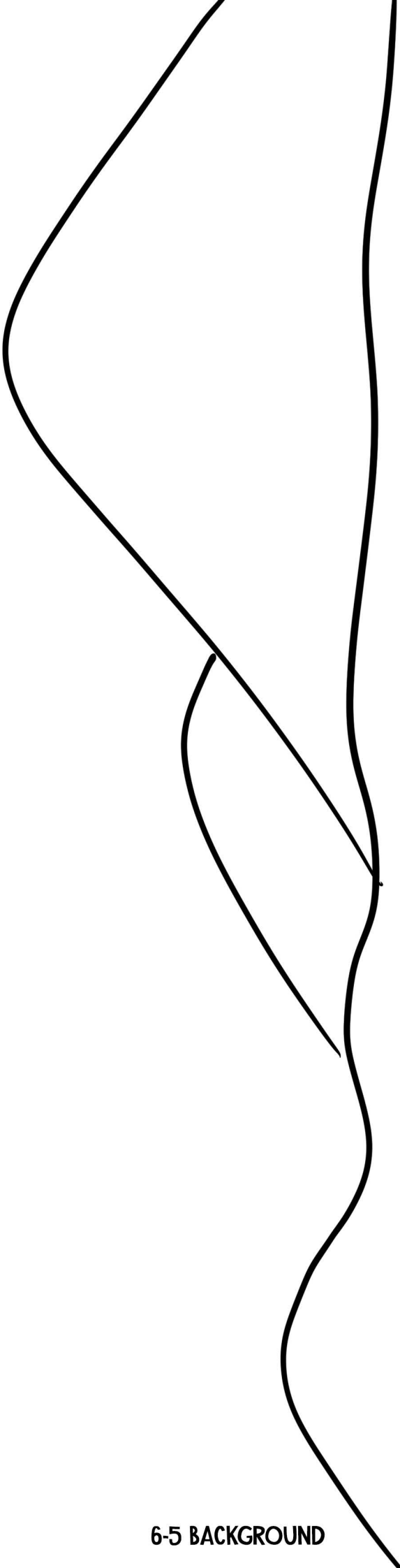

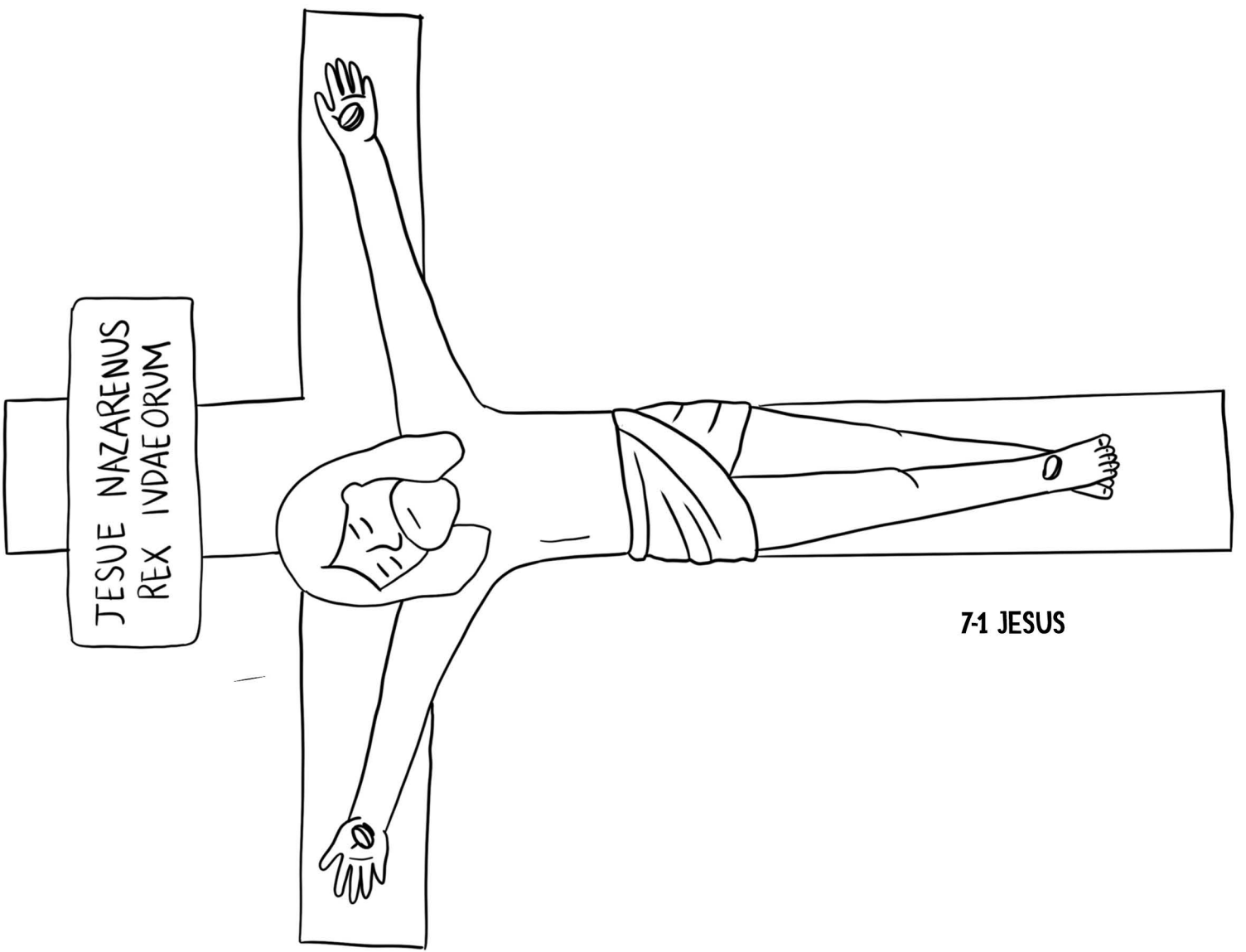

7-1 JESUS

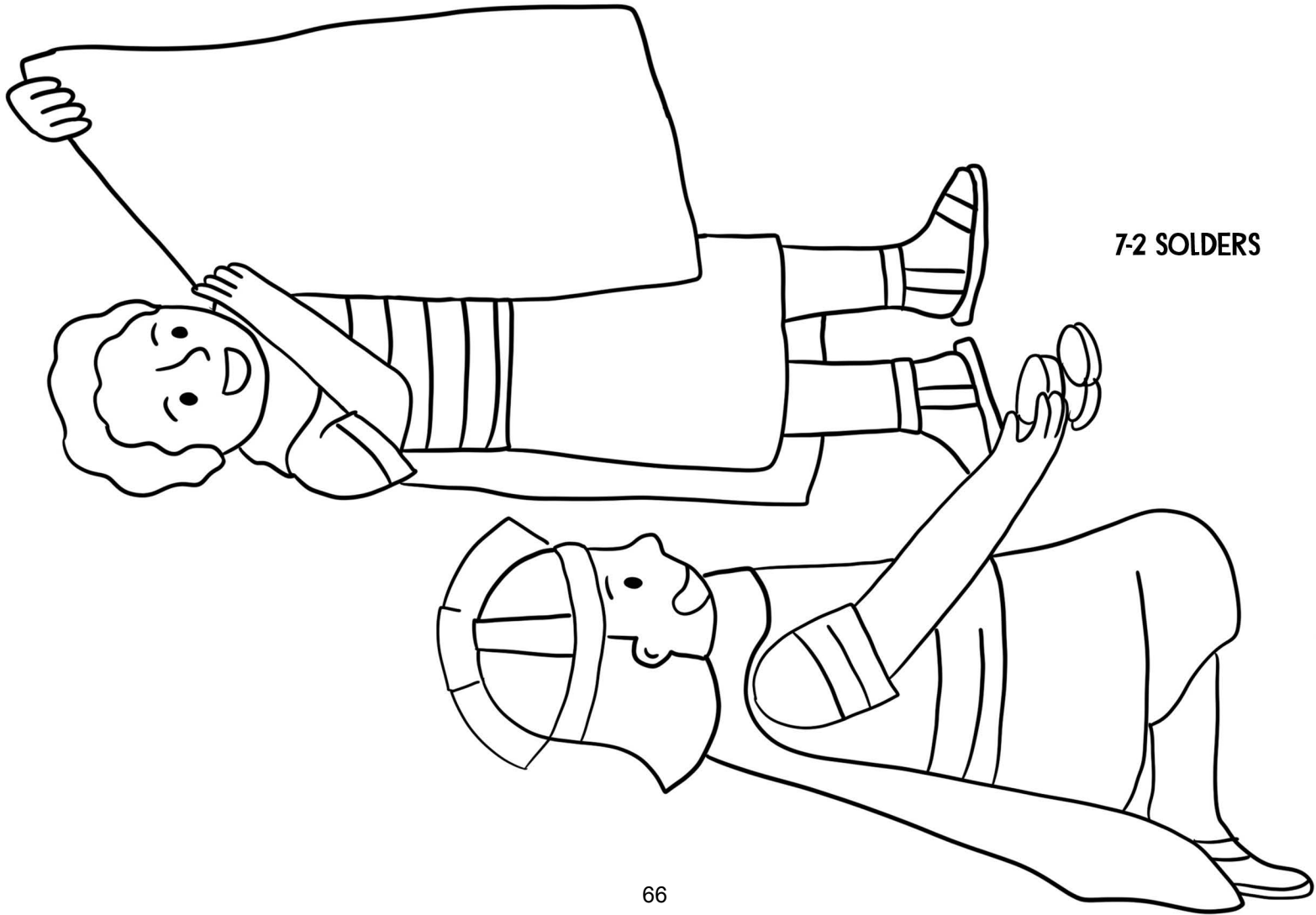

7-2 SOLDERS

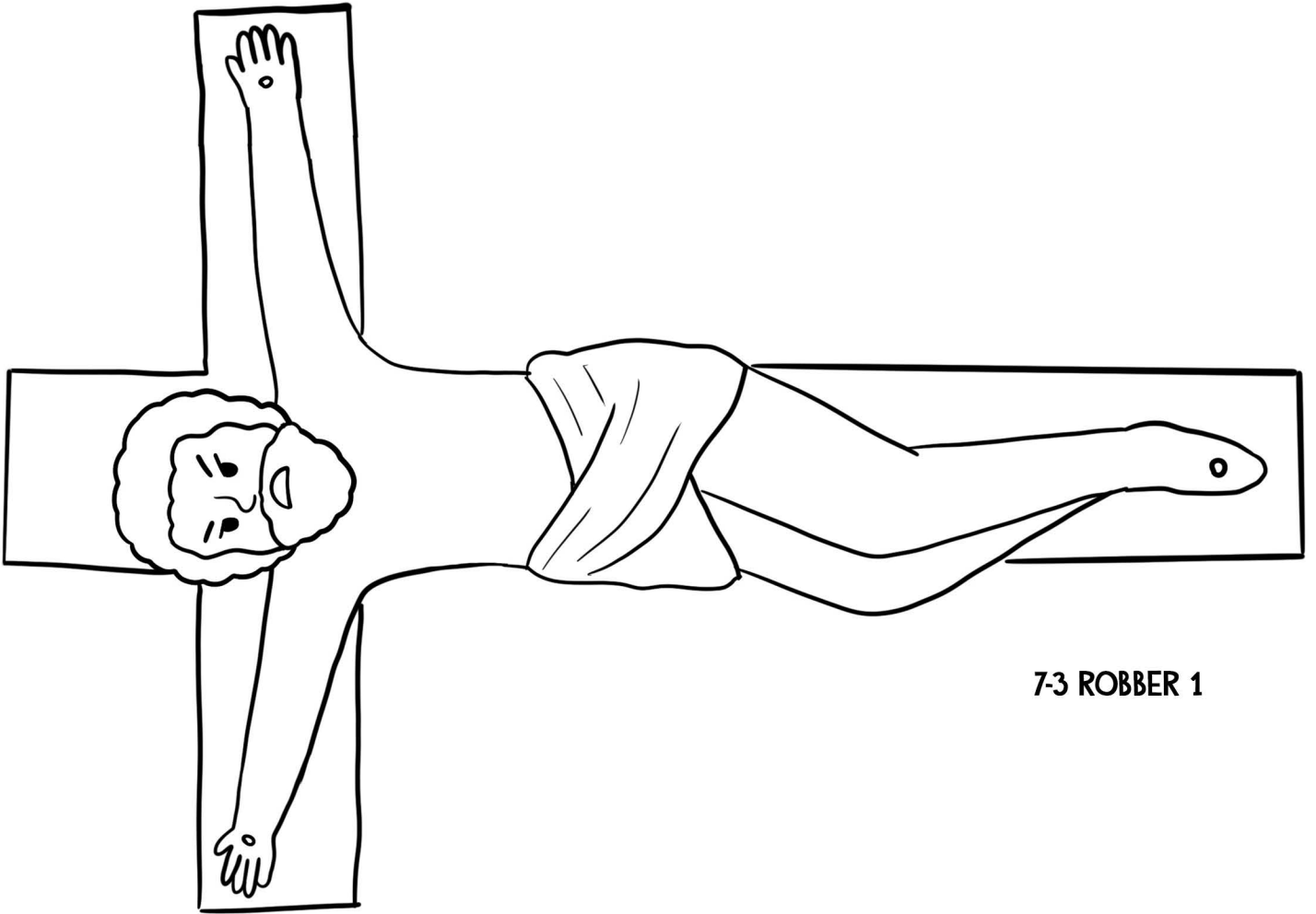

7-3 ROBBER 1

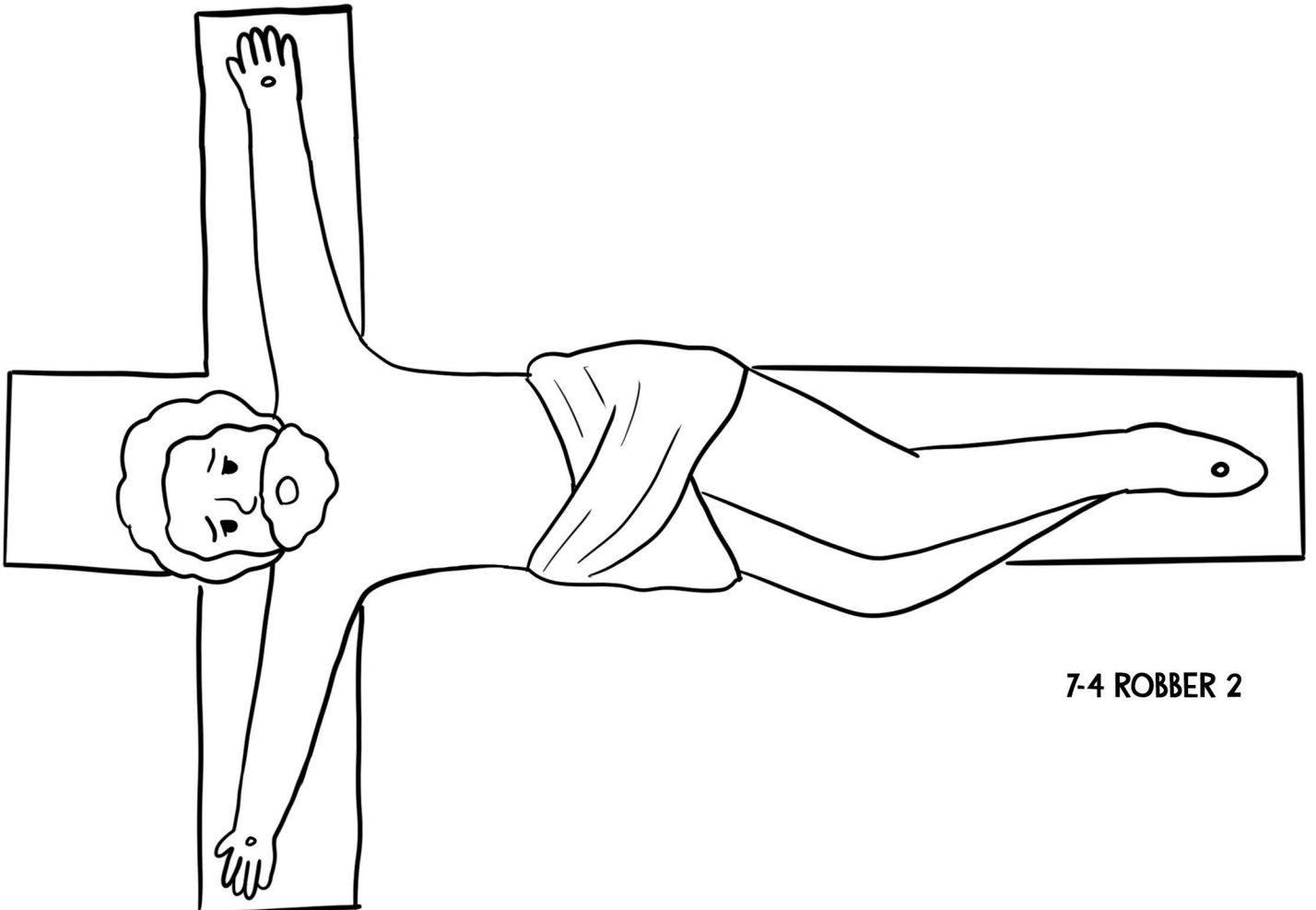

7-4 ROBBER 2

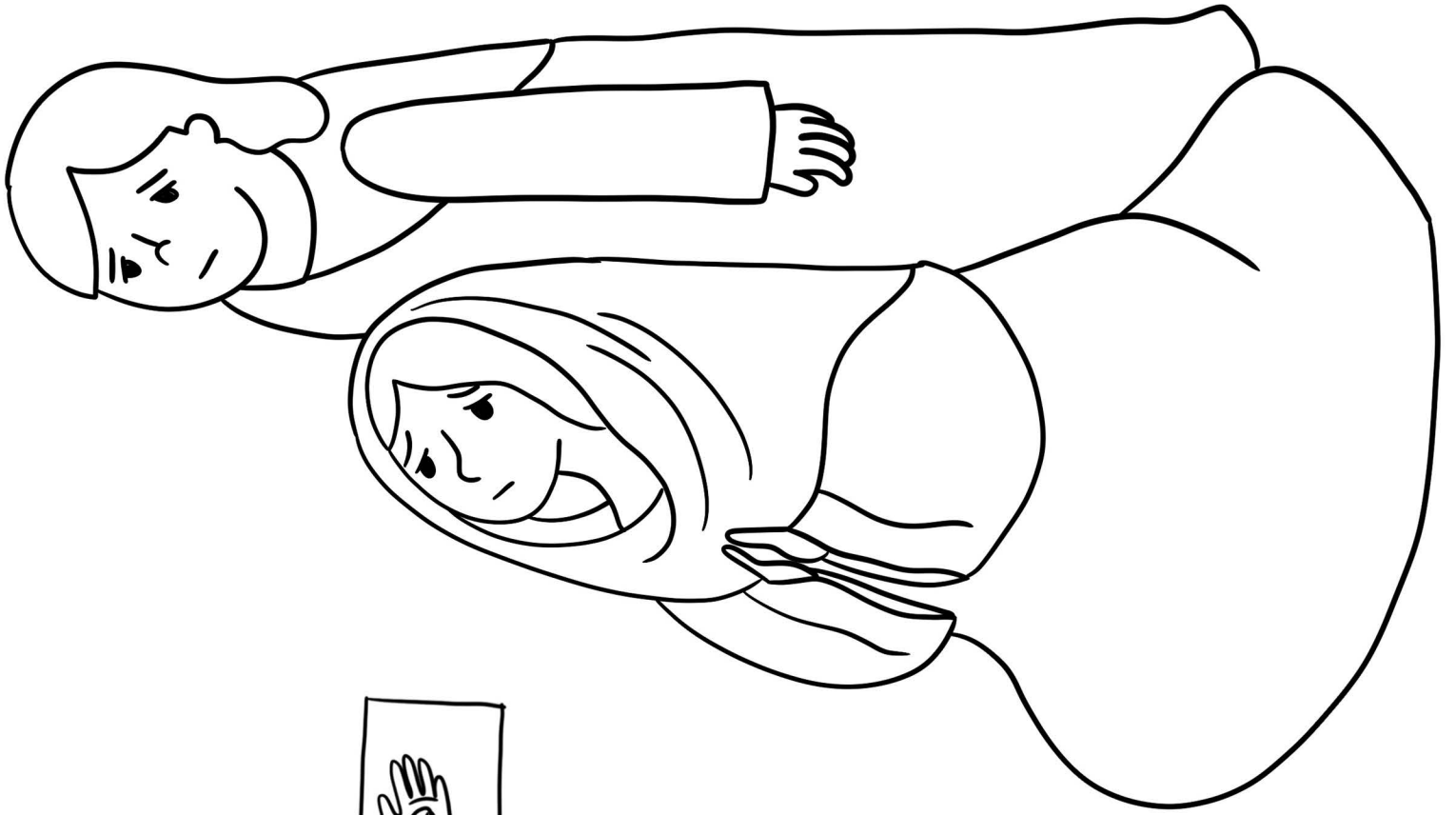

8-1 MARIA AND JOHN

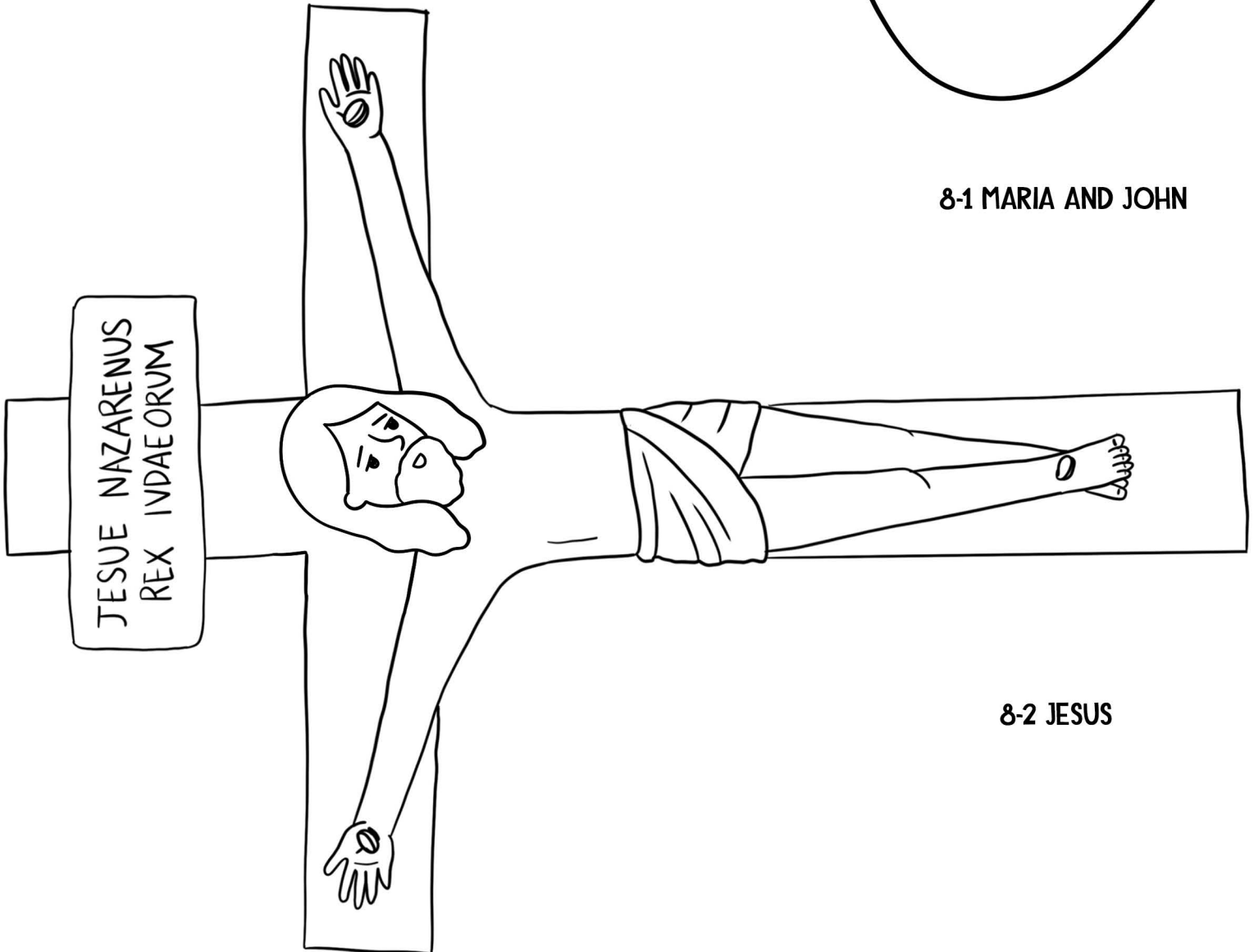

8-2 JESUS

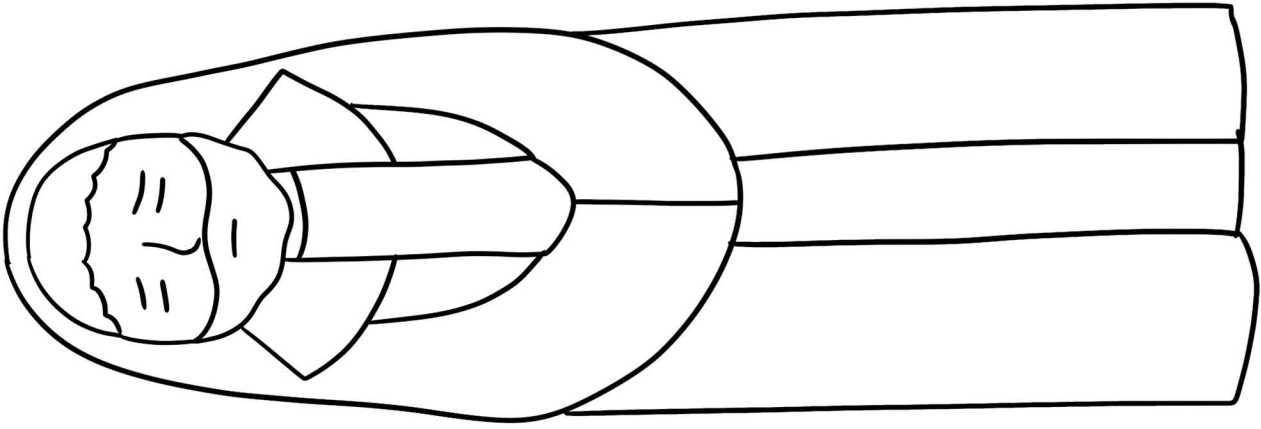

8-3 JOSHEP

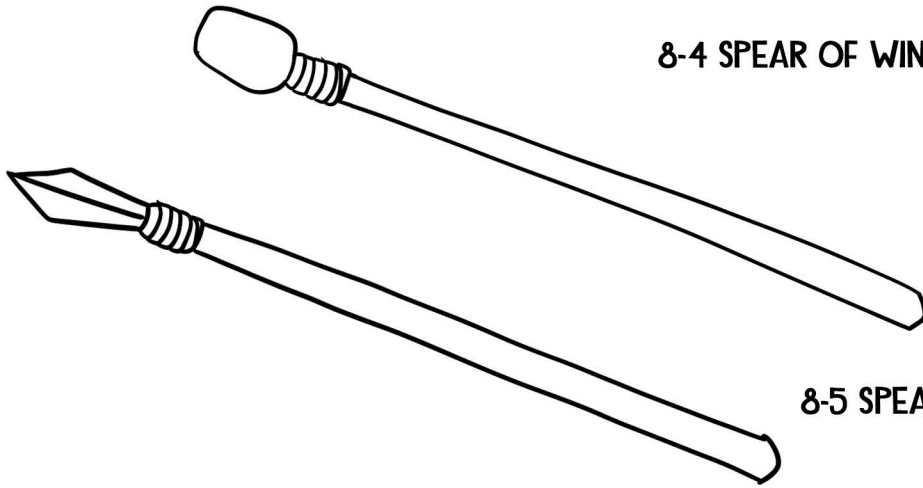

8-4 SPEAR OF WINE

8-5 SPEAR

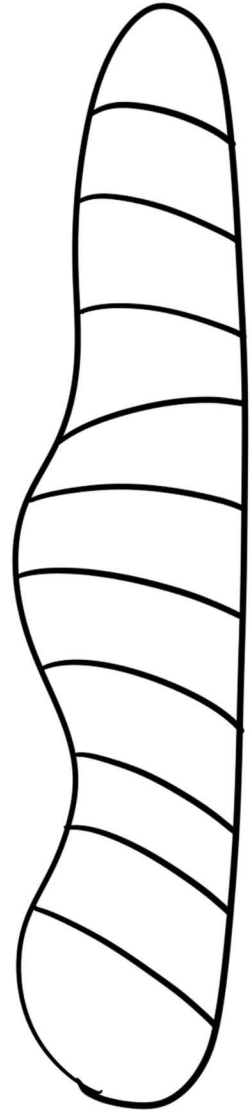

8-6

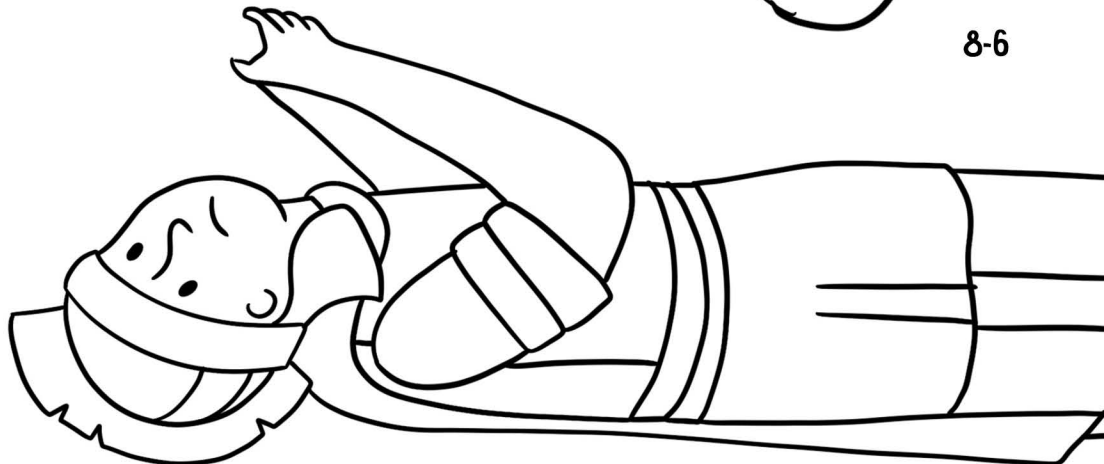

8-7 SOLDER

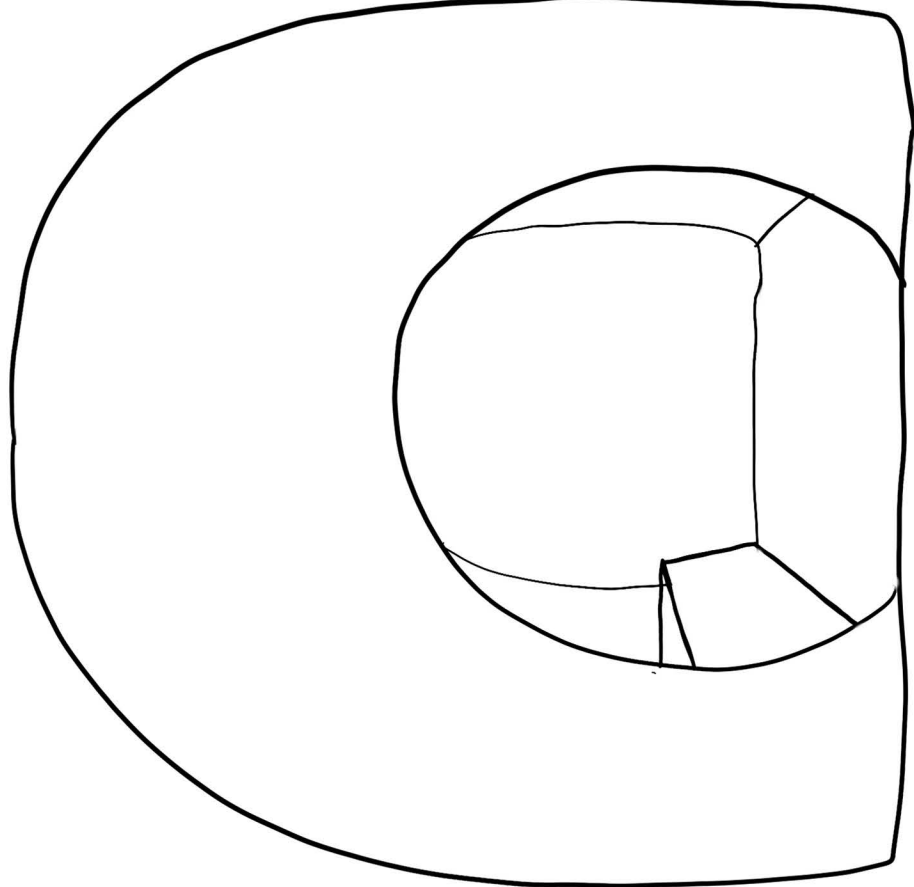

9-1 GRAVE

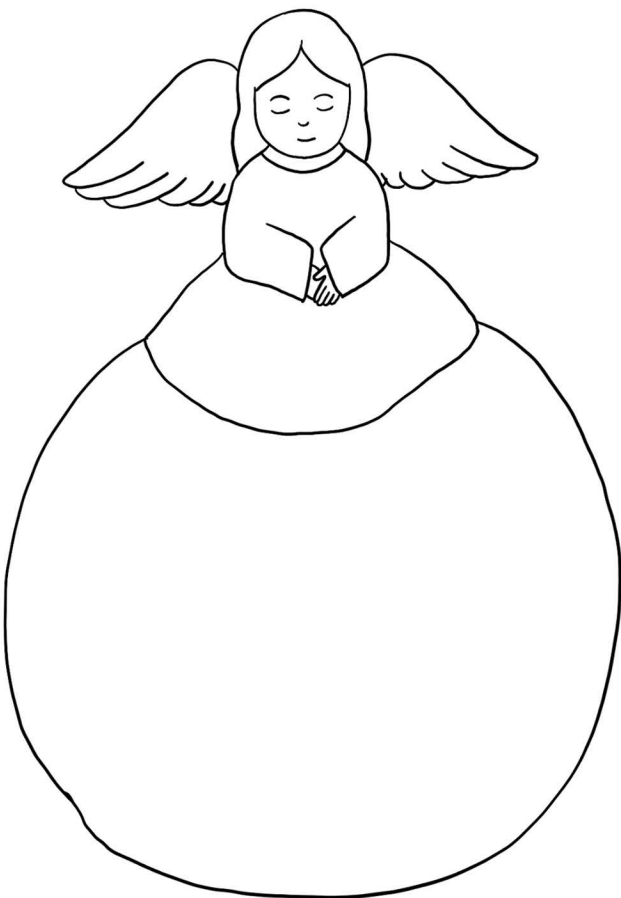

9-2 ANGEL WITH GRAVE DOOR

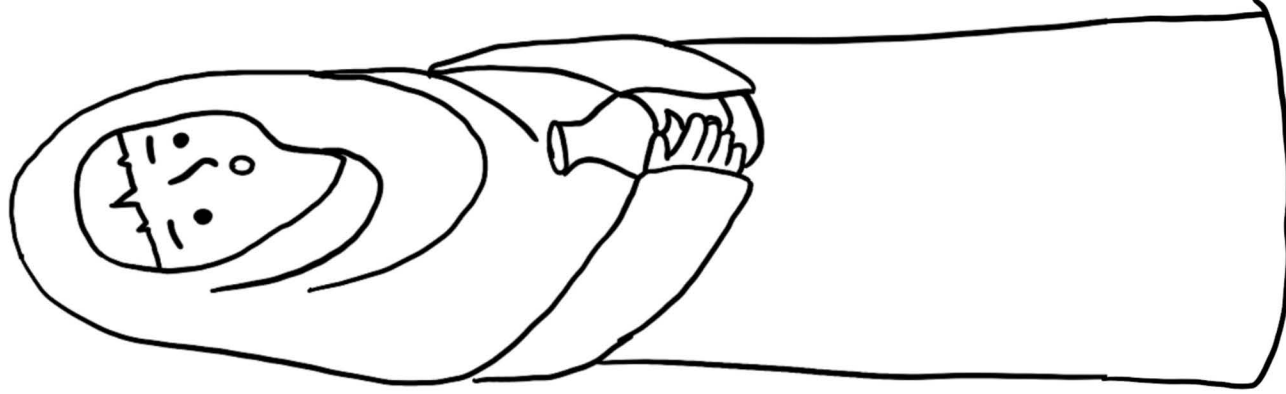
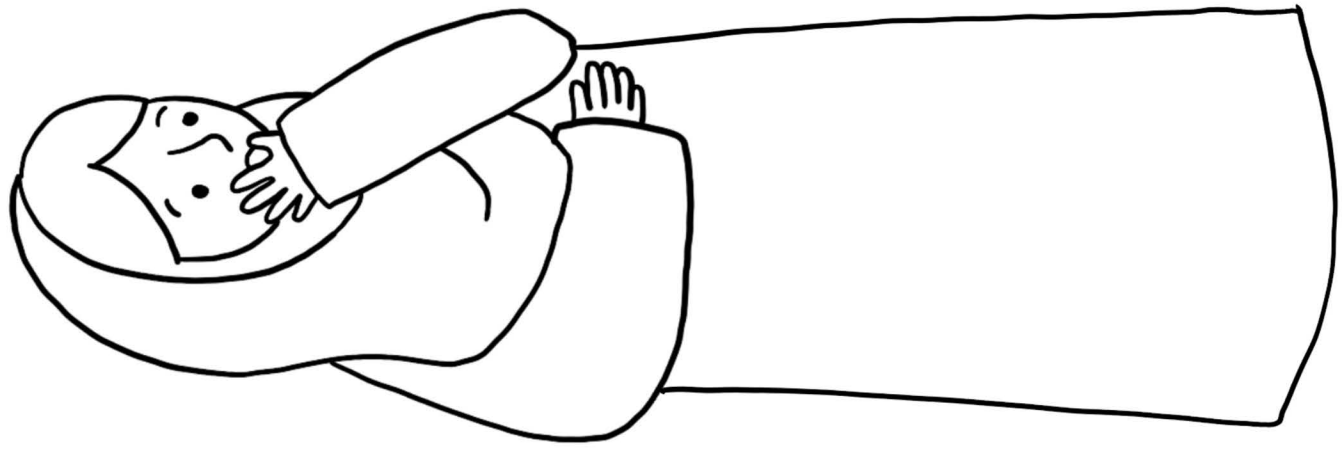

9-3 TWO WOMEN

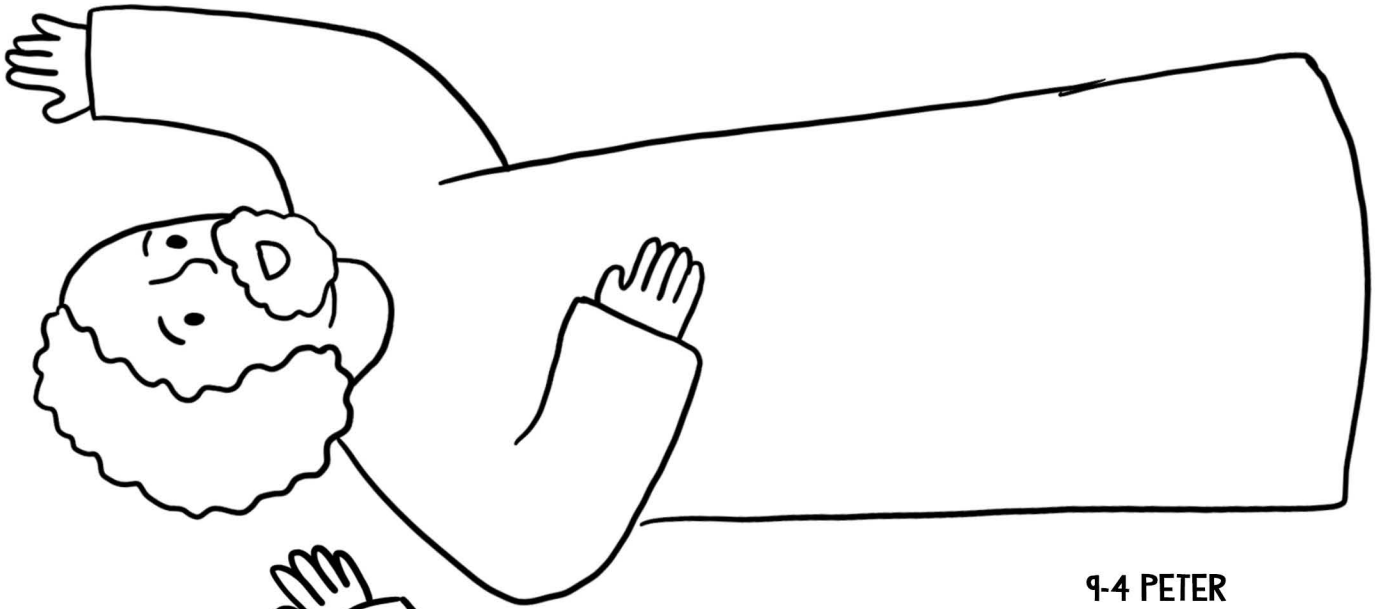

9-4 PETER

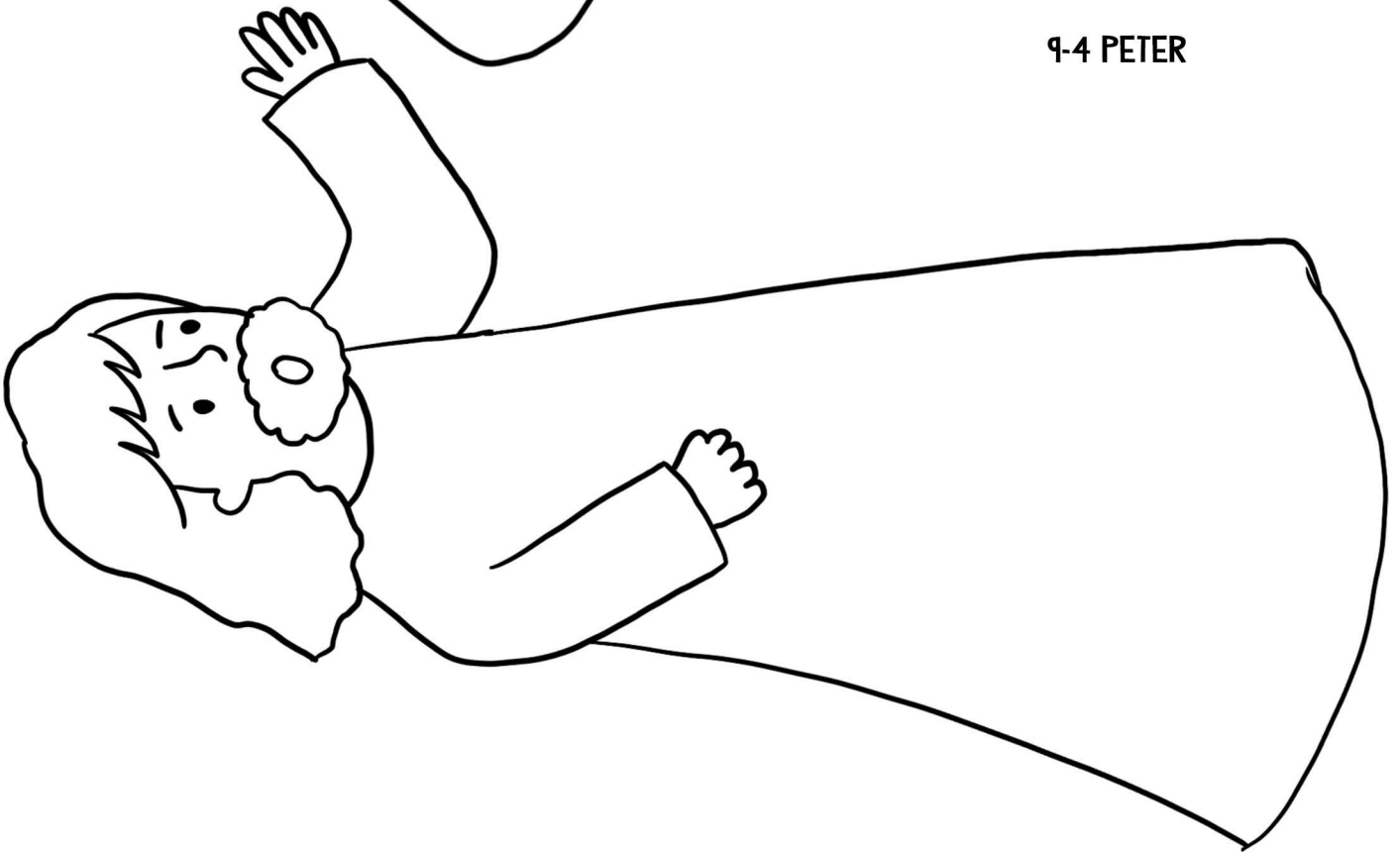

9-5 JOSEPH

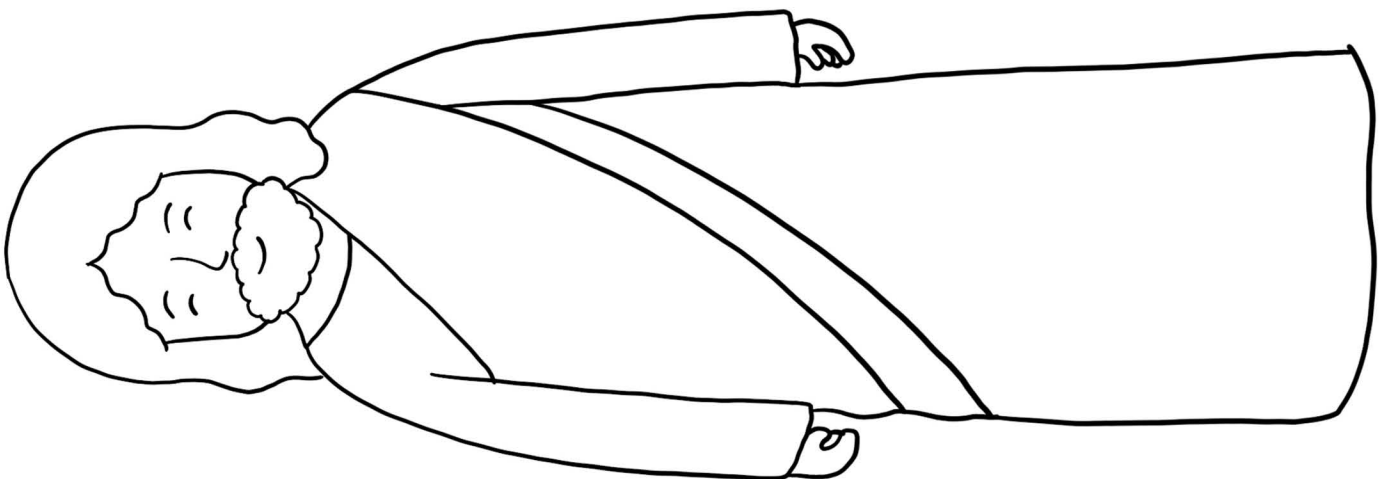

9-6 JESUS

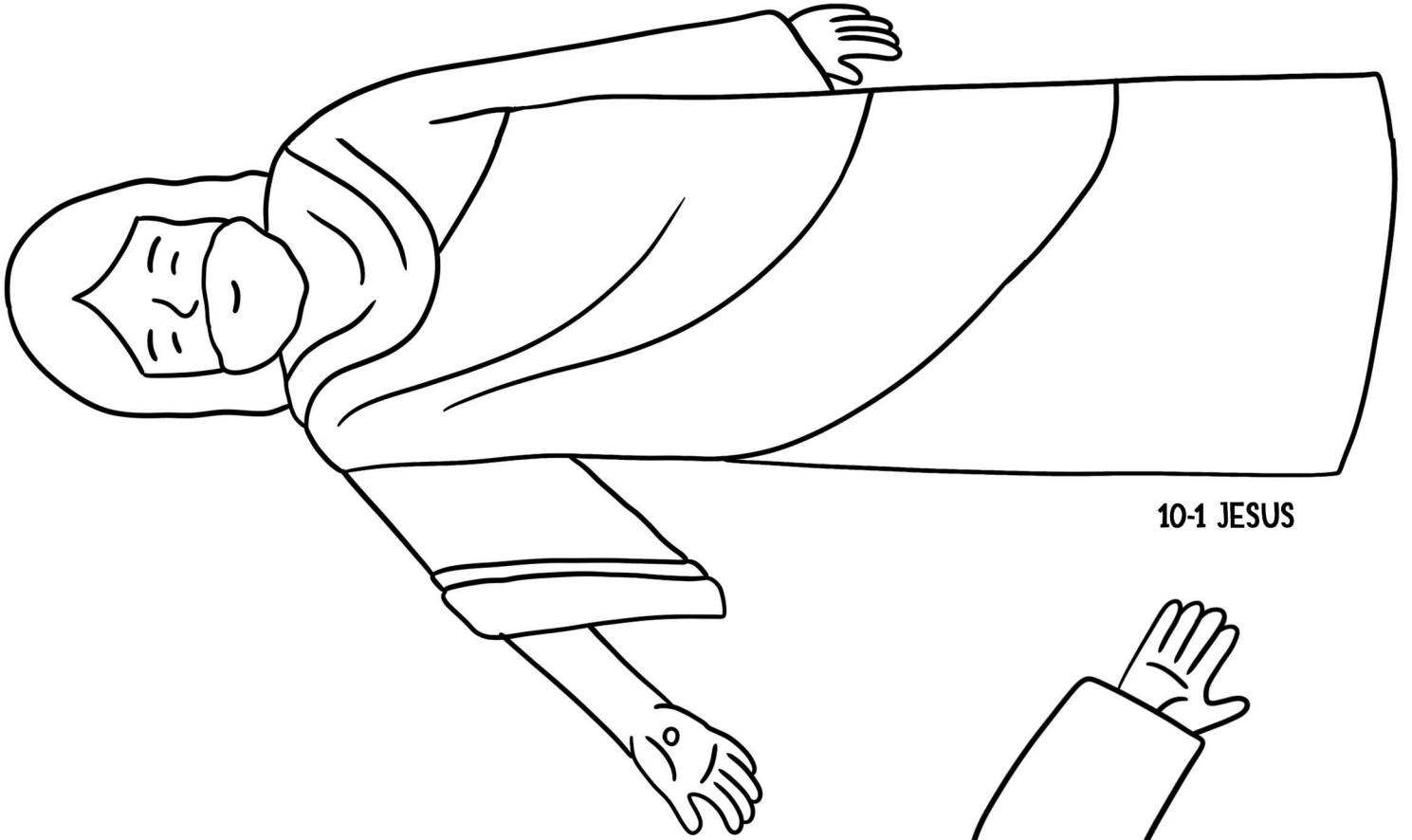

10-1 JESUS

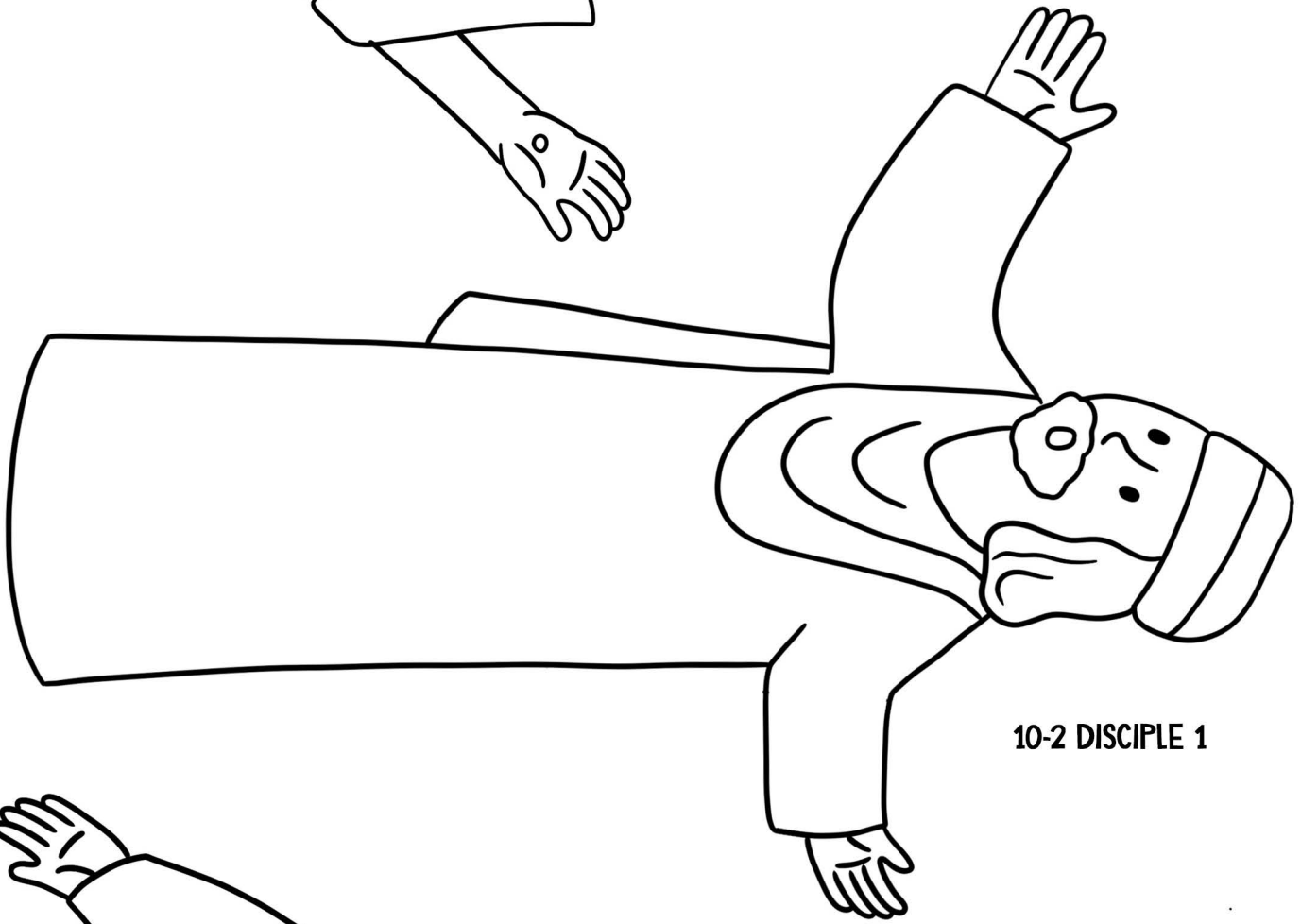

10-2 DISCIPLE 1

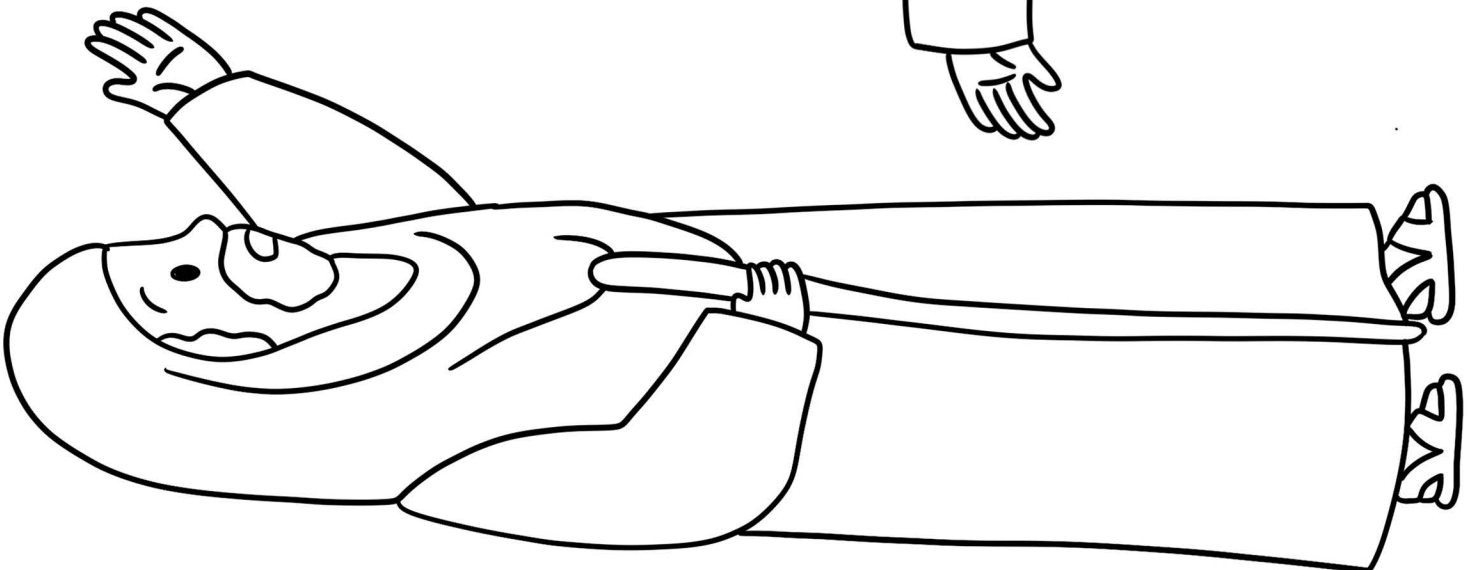

10-3 DISCIPLE 2

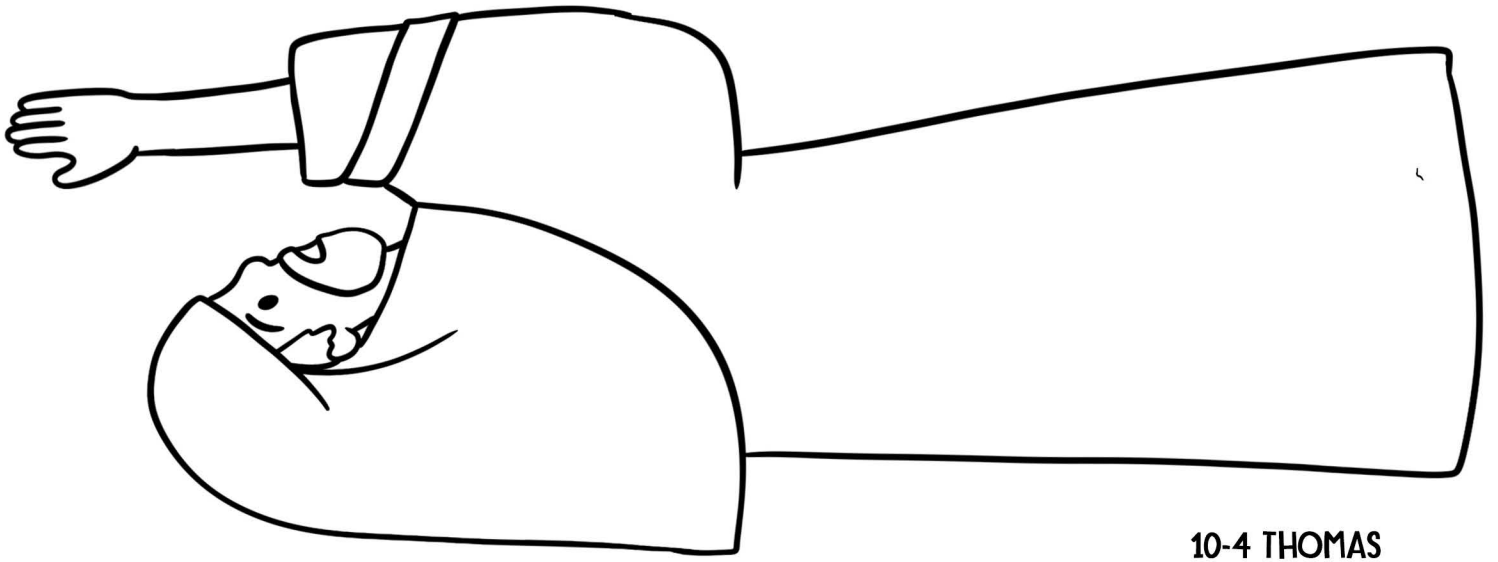

10-4 THOMAS

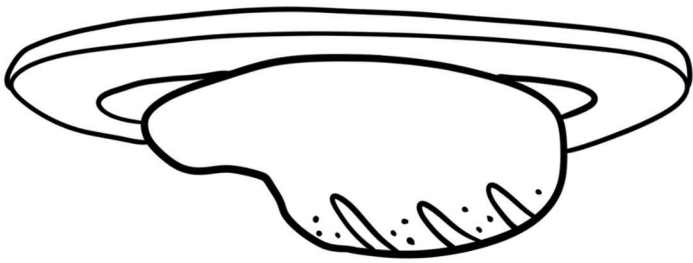

10-5 BREAD

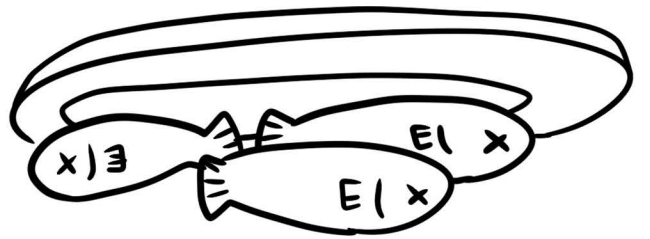

10-6 FISHES

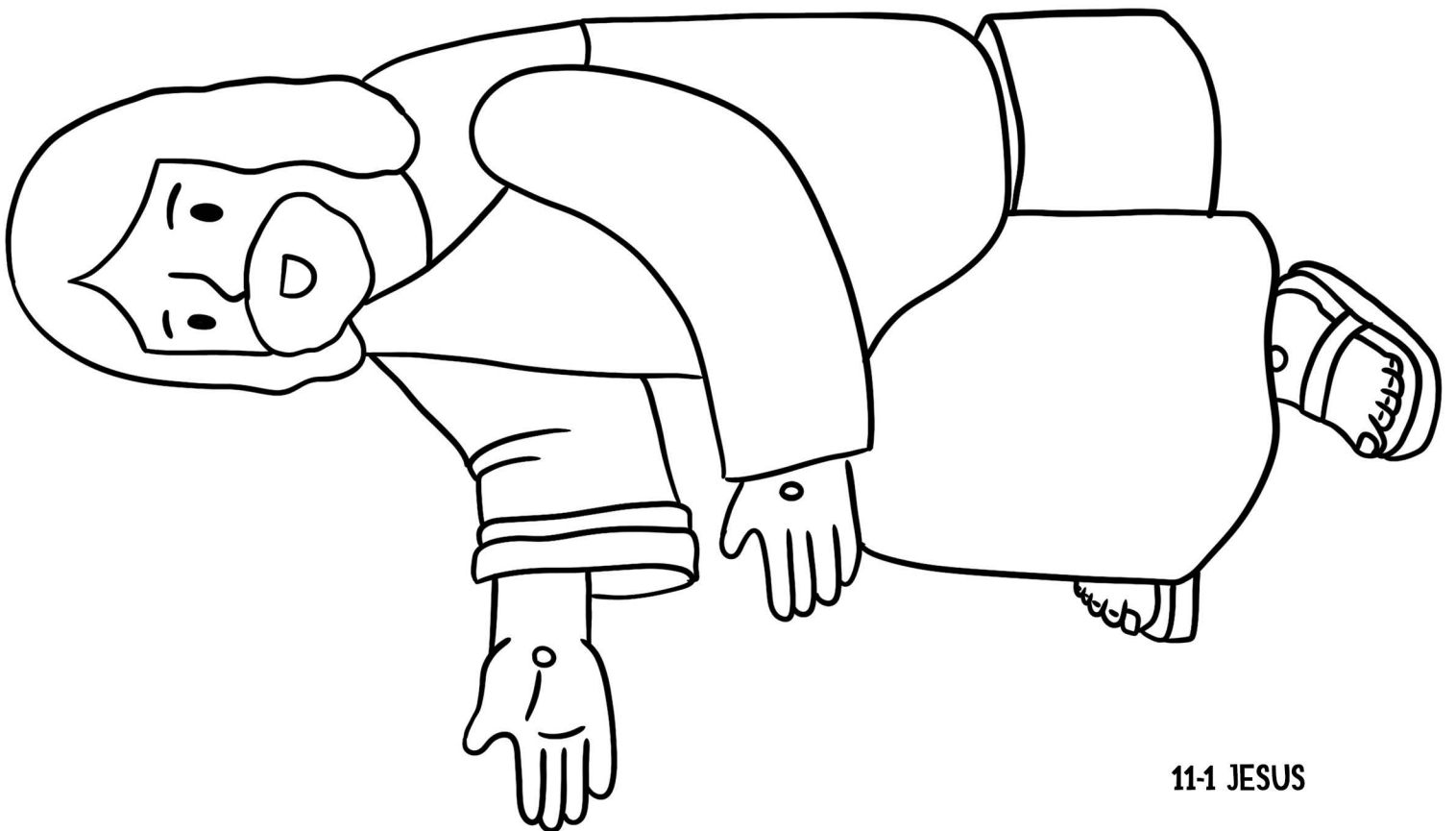

11-1 JESUS

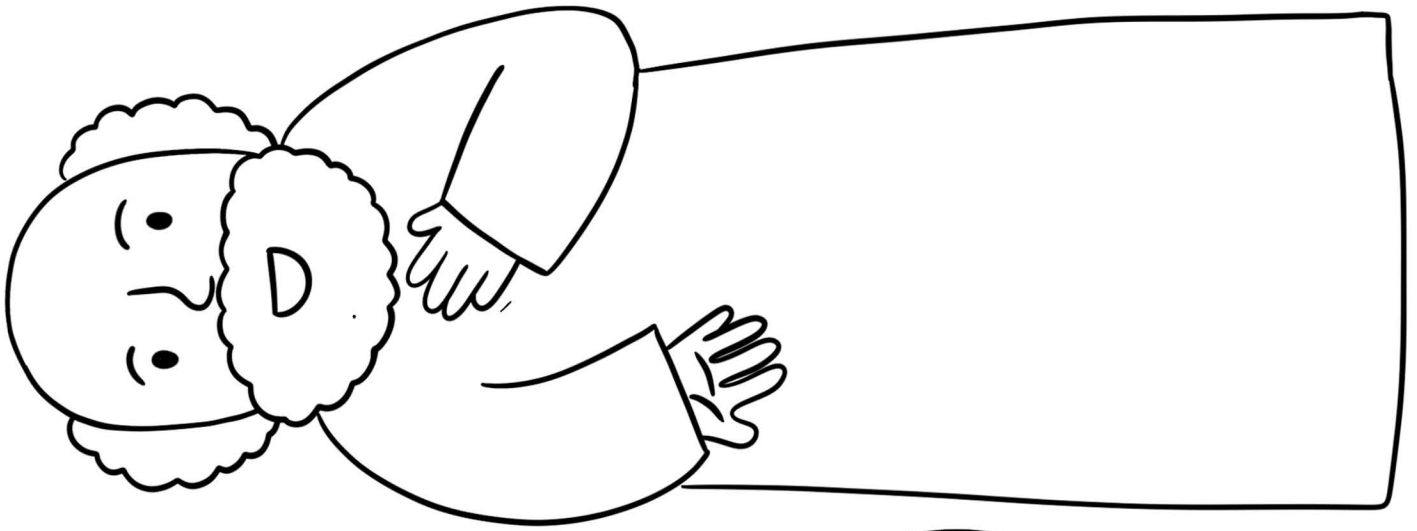

11-2 PETER

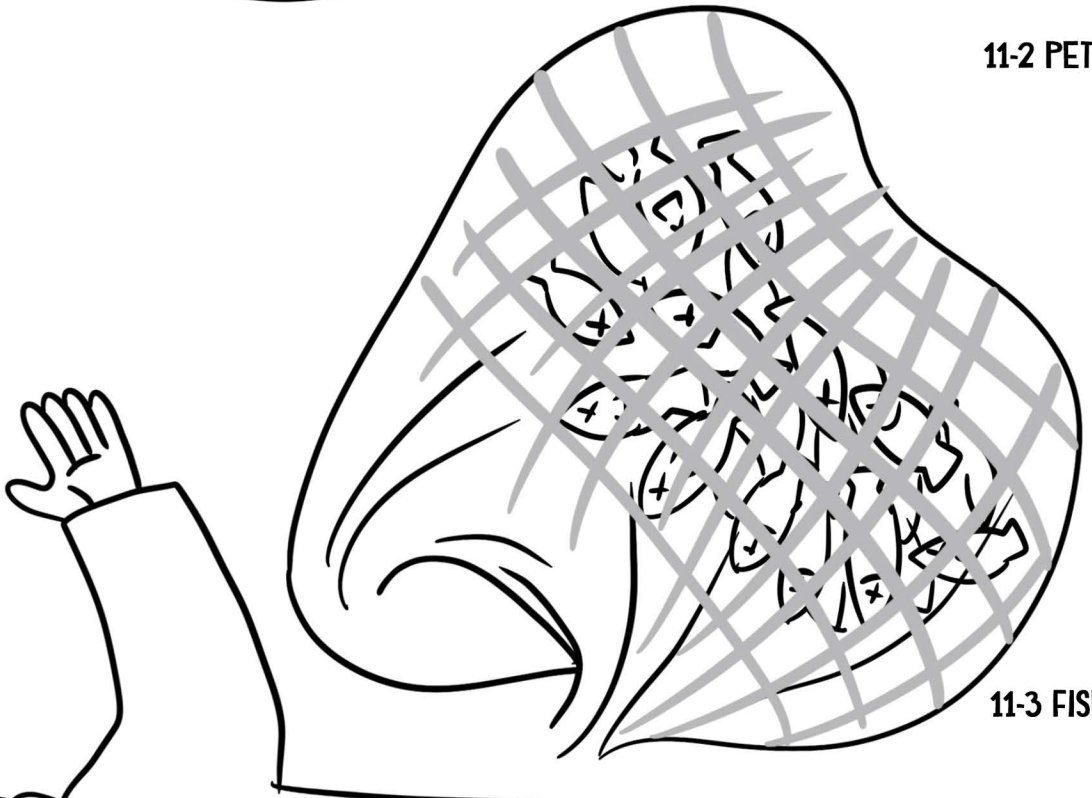

11-3 FISHES

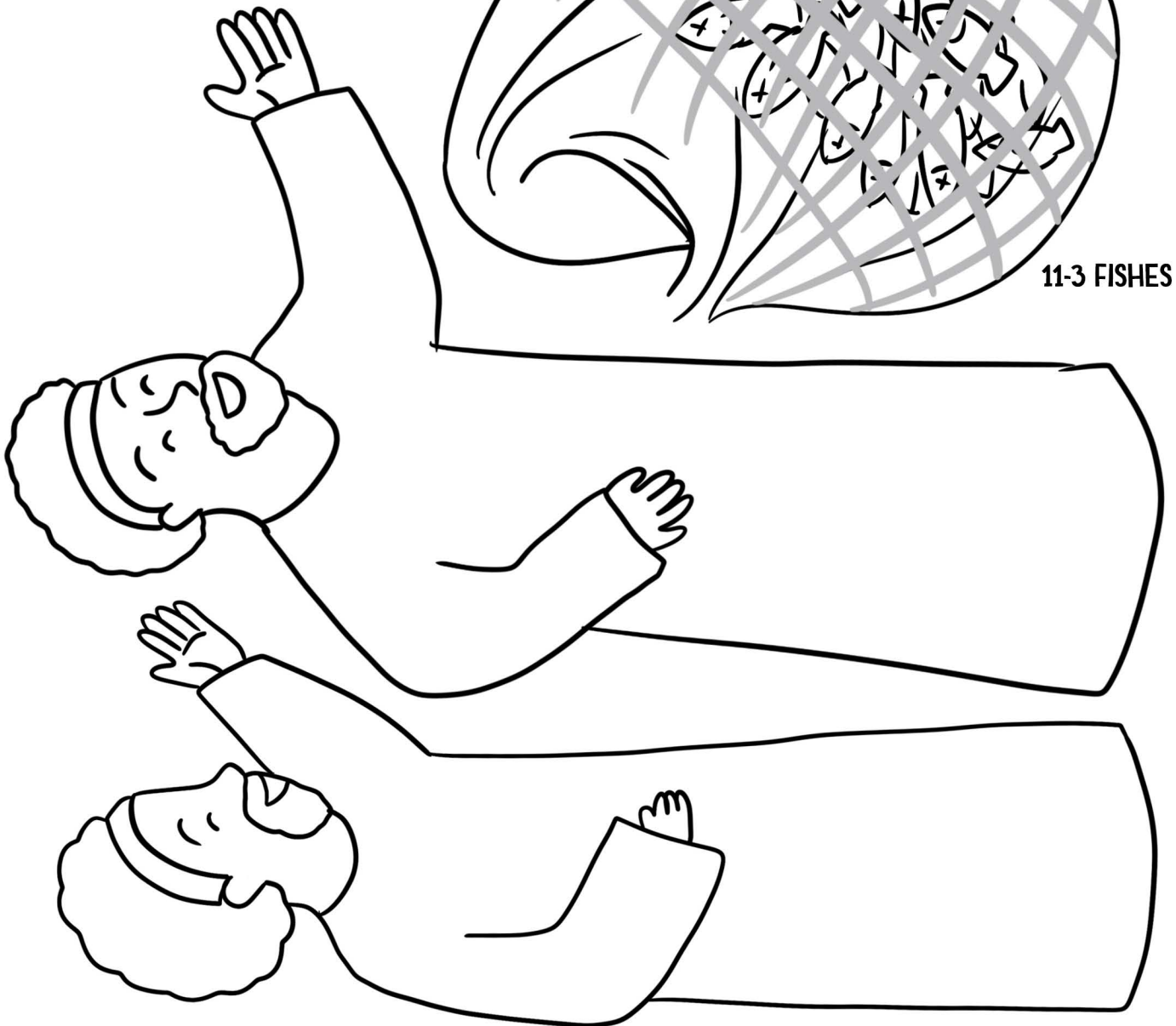

11-4 DISCIPLES

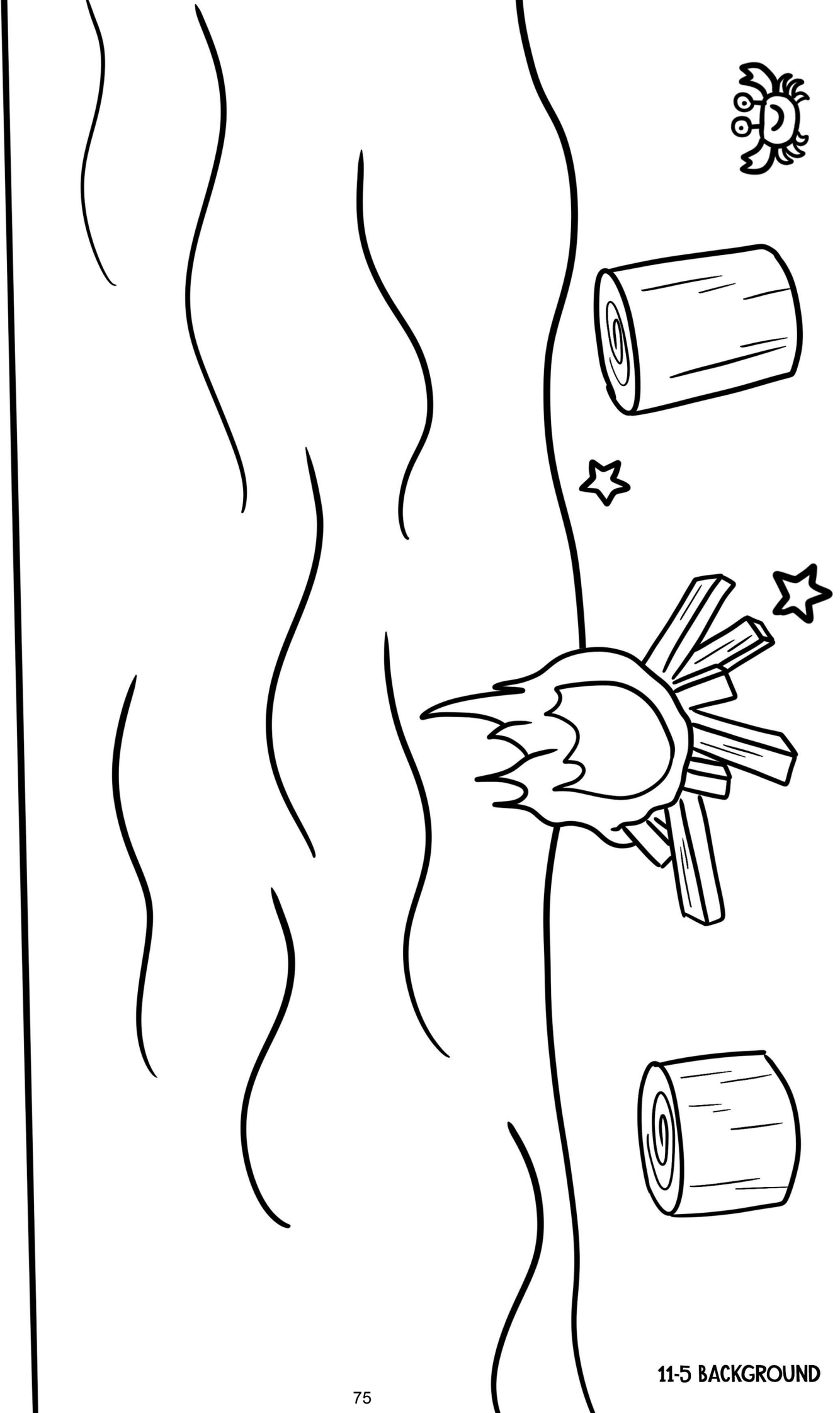

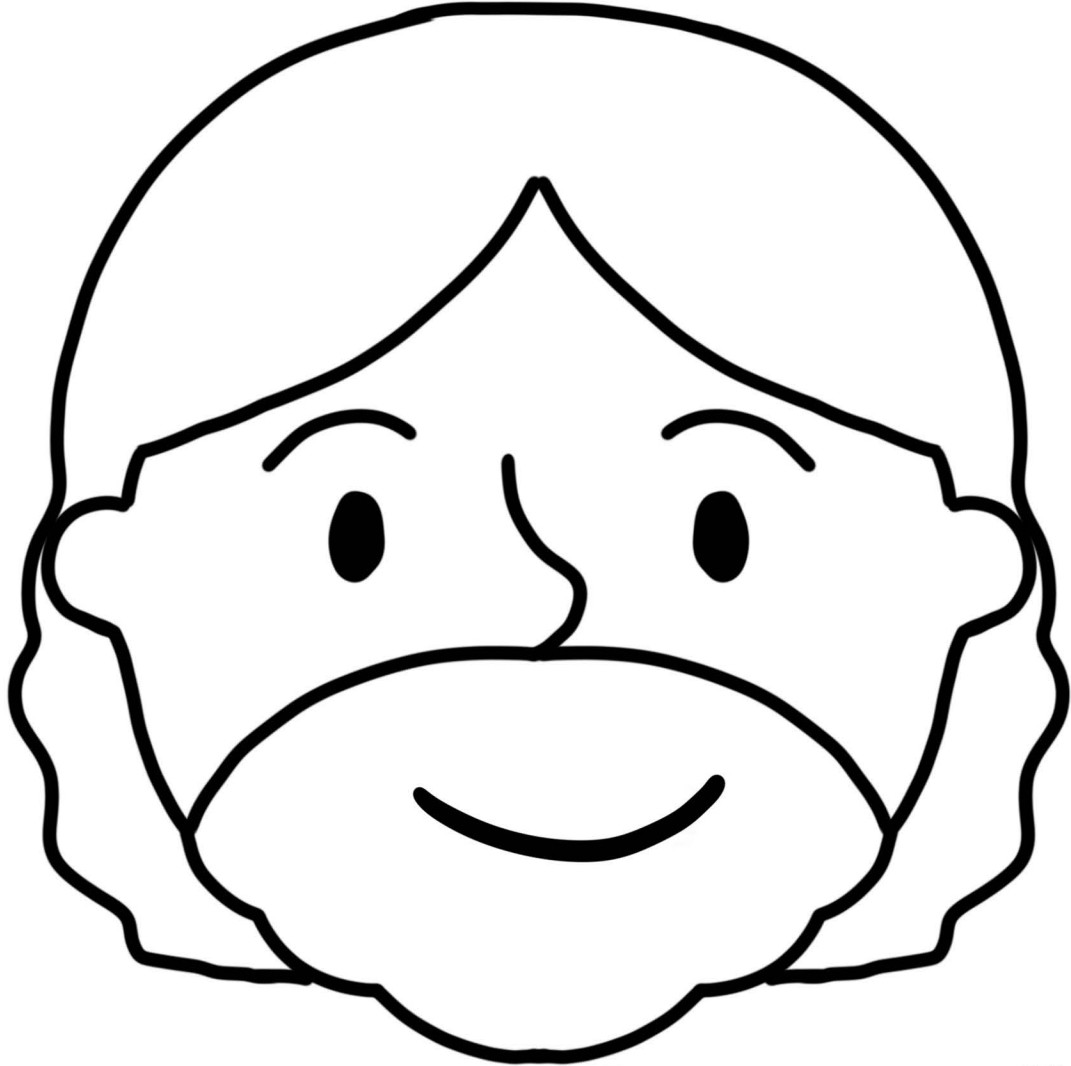

12-1 JESUS

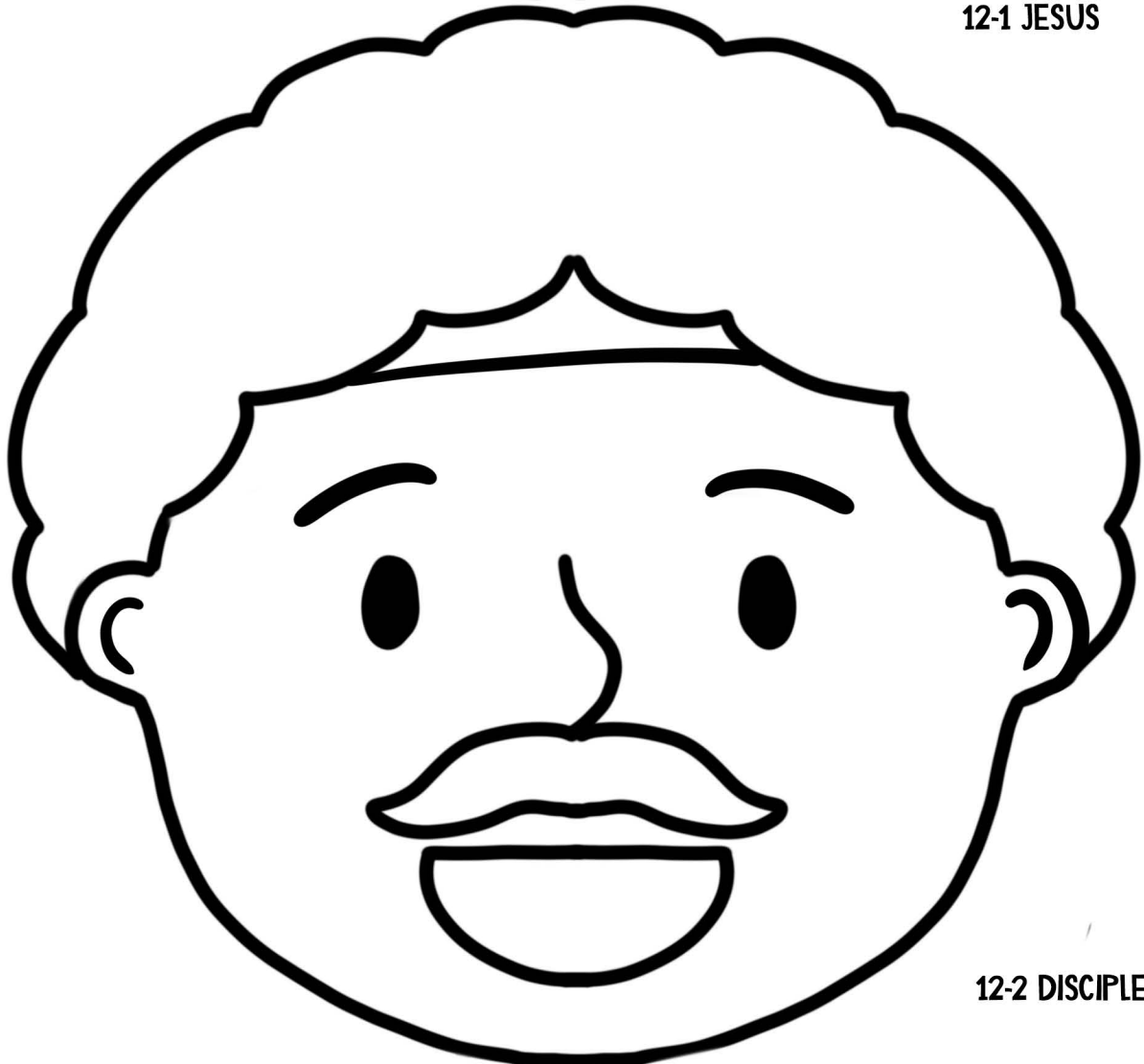

12-2 DISCIPLE 1

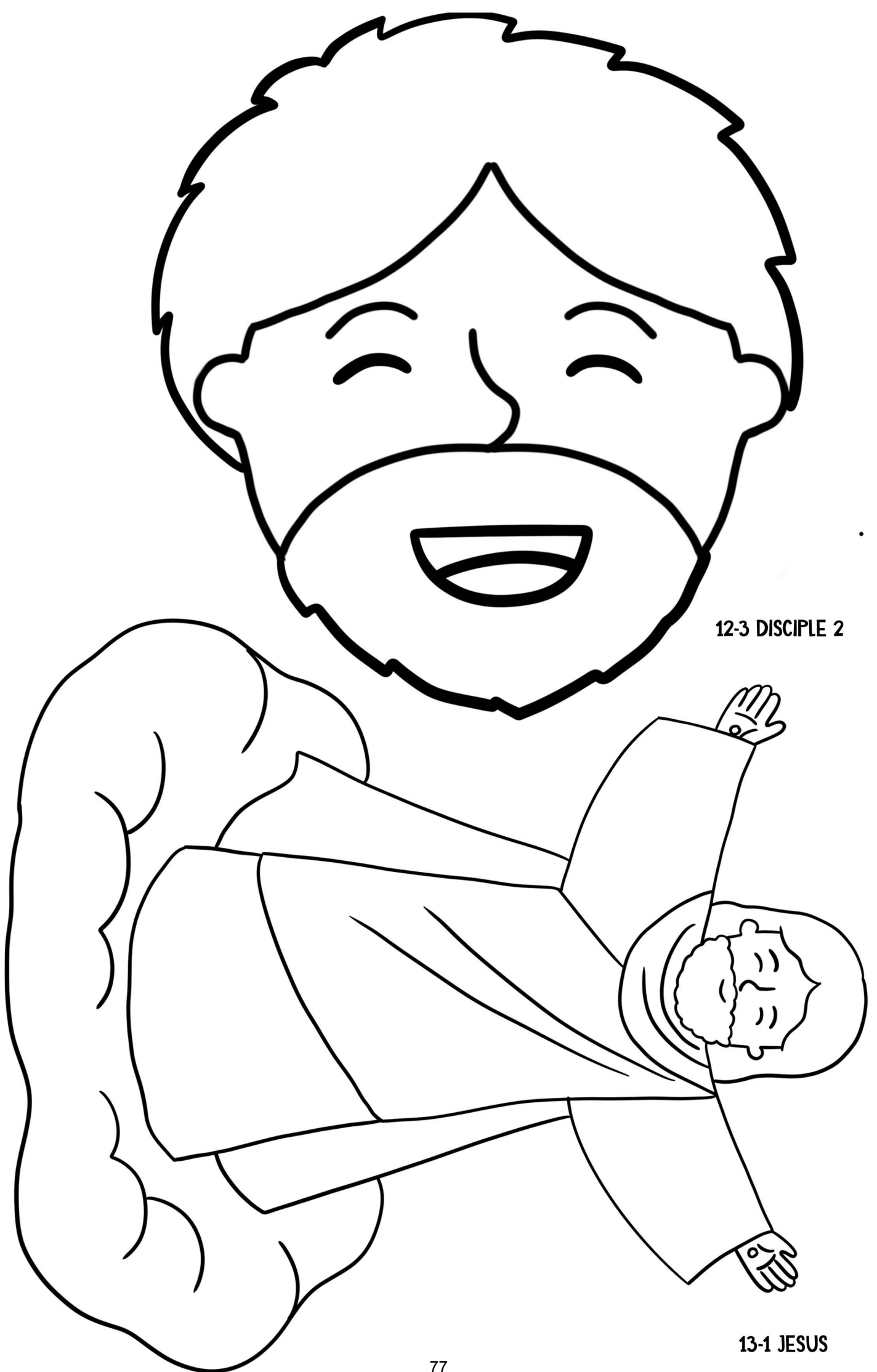

12-3 DISCIPLE 2

13-1 JESUS



13-2 TWO PEOPLE IN
WHITE CLOTHES

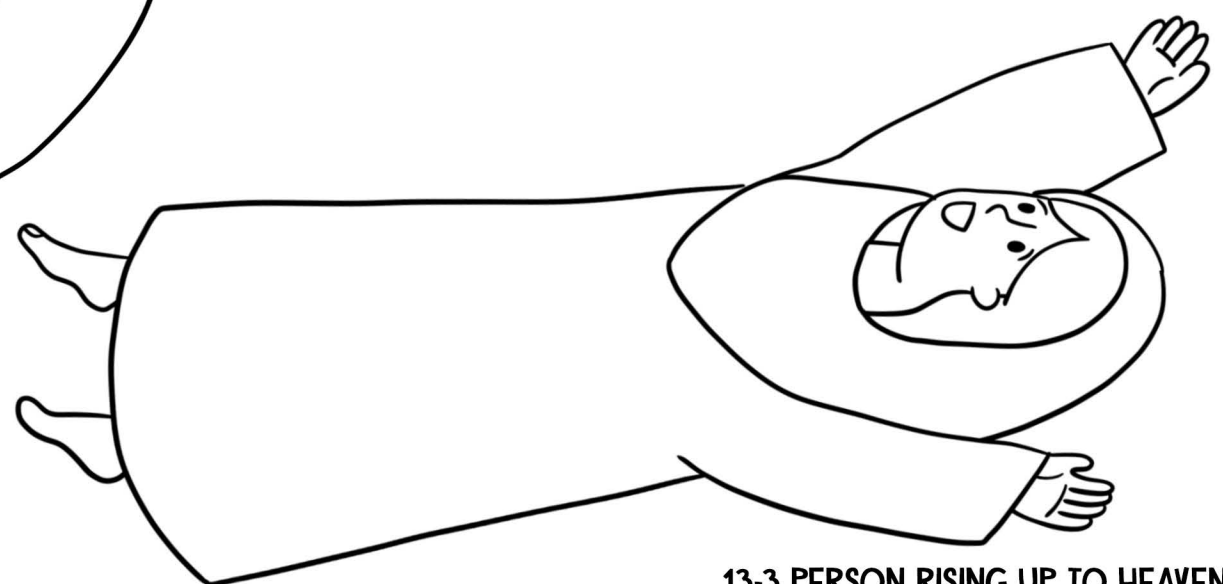

13-3 PERSON RISING UP TO HEAVEN

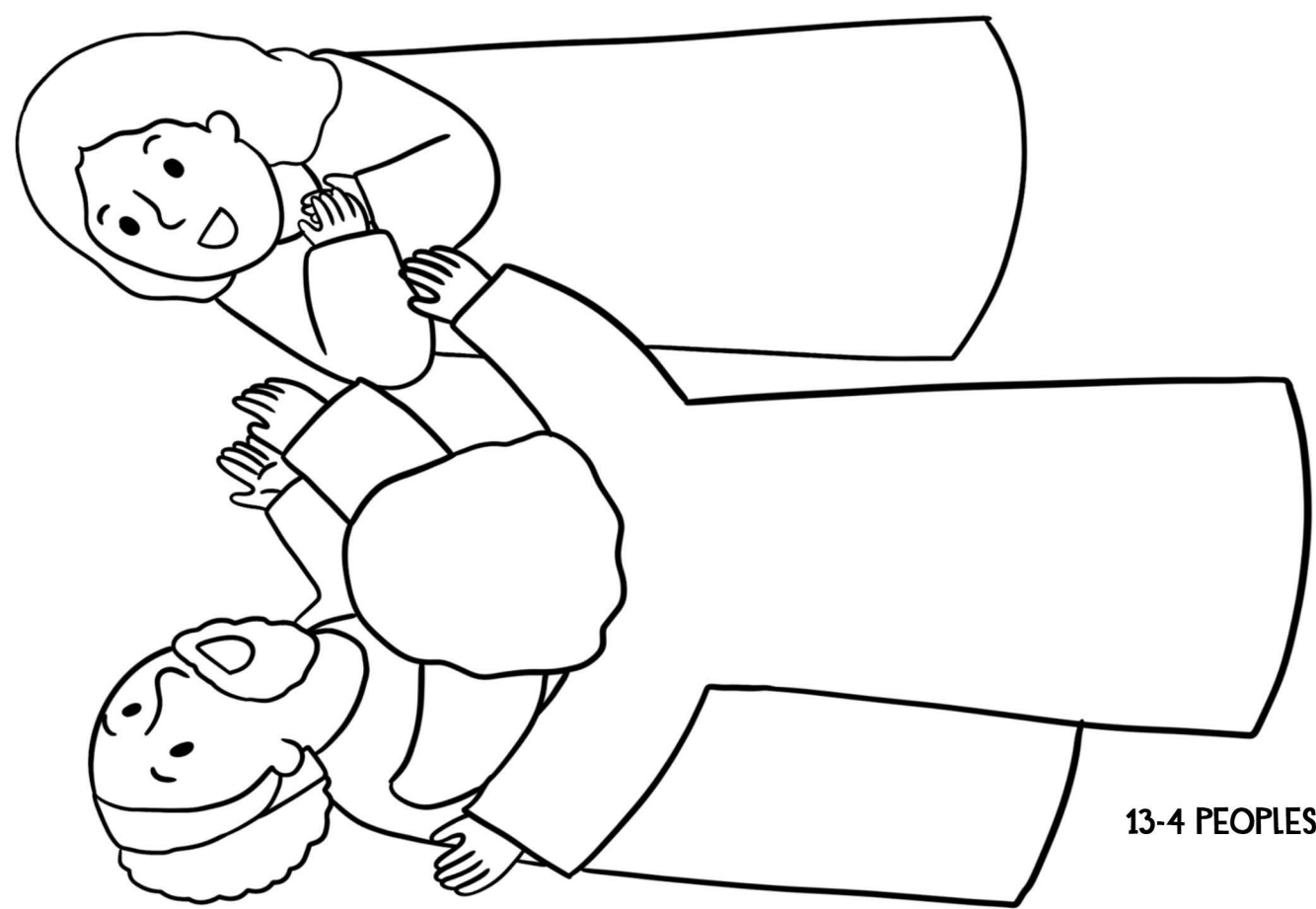

13-4 PEOPLES



14-1 PETER

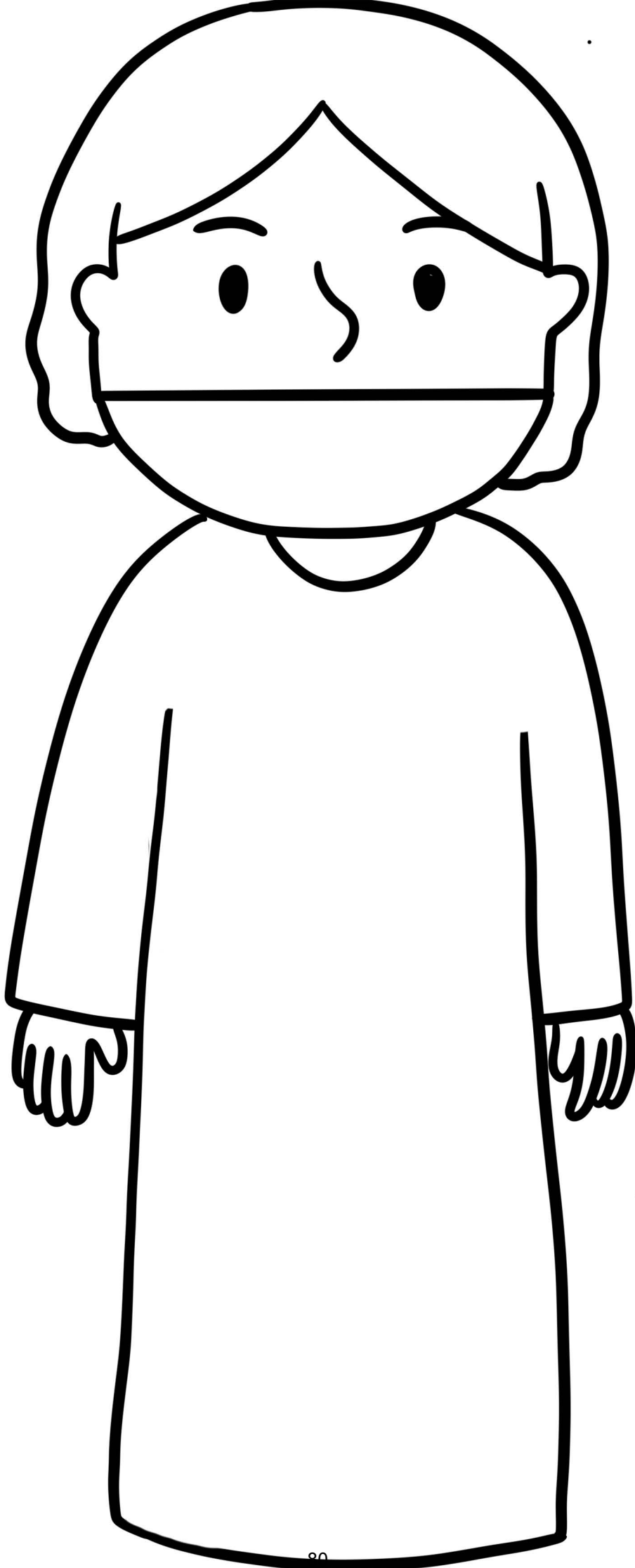

14-2 JOHN

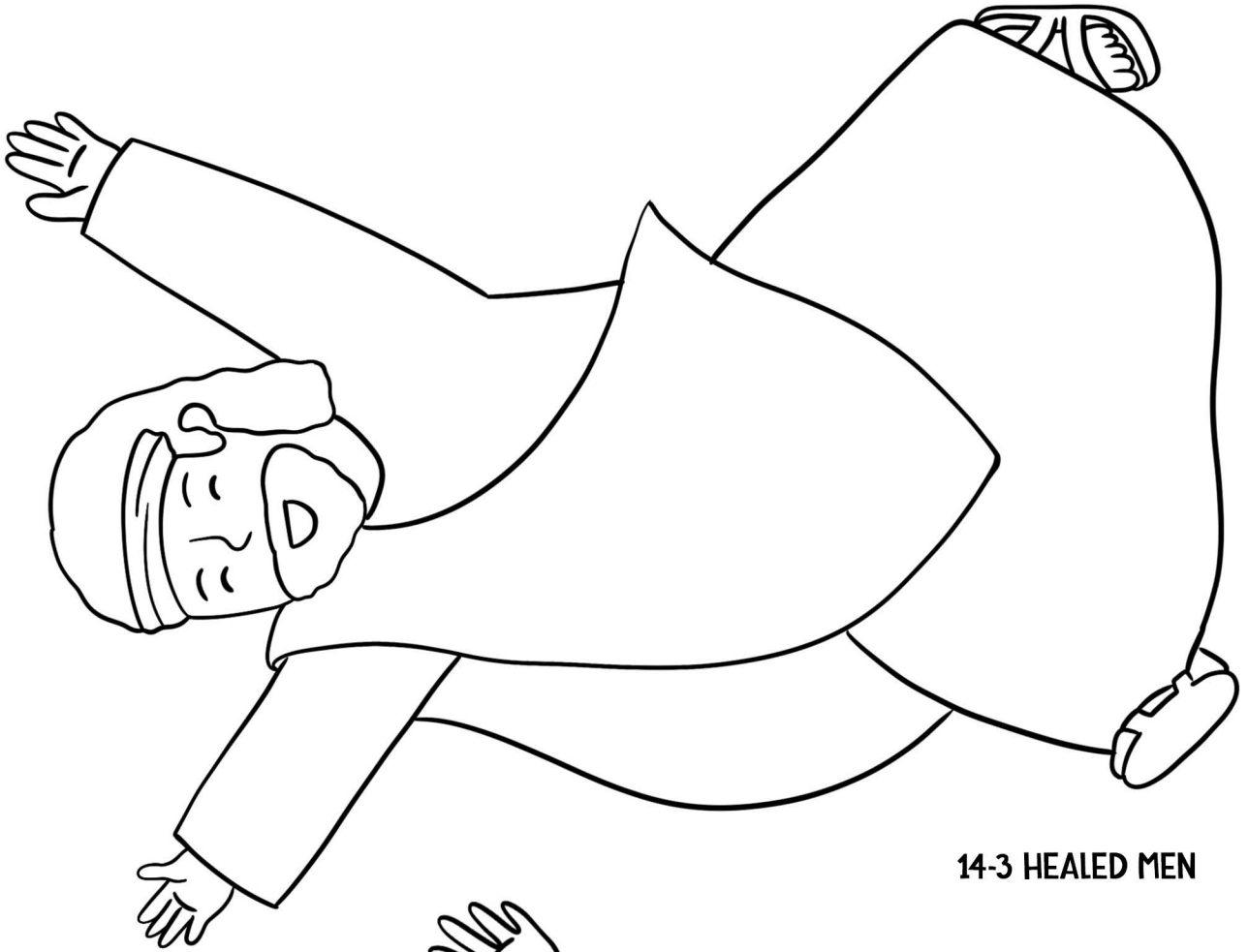

14-3 HEALED MEN

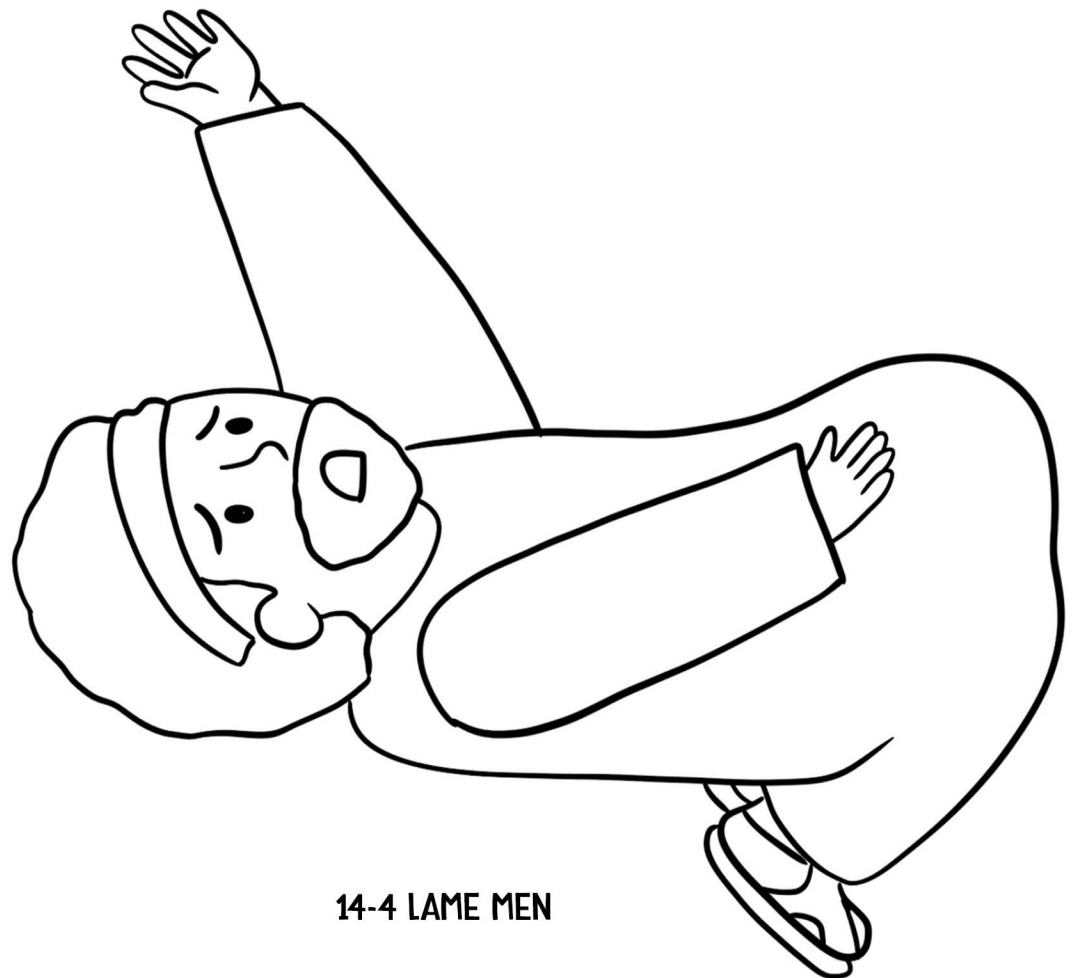

14-4 LAME MEN

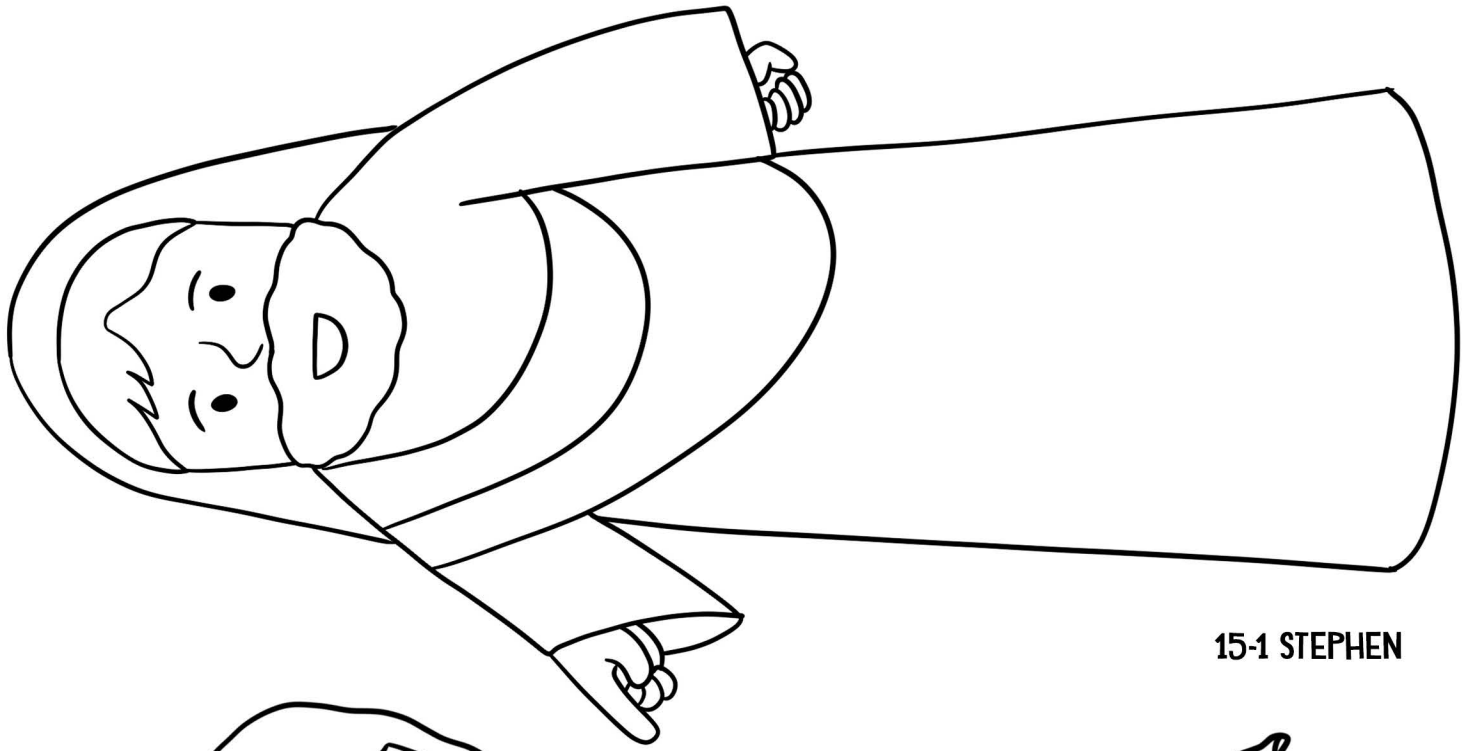

15-1 STEPHEN



15-2 STEPEN

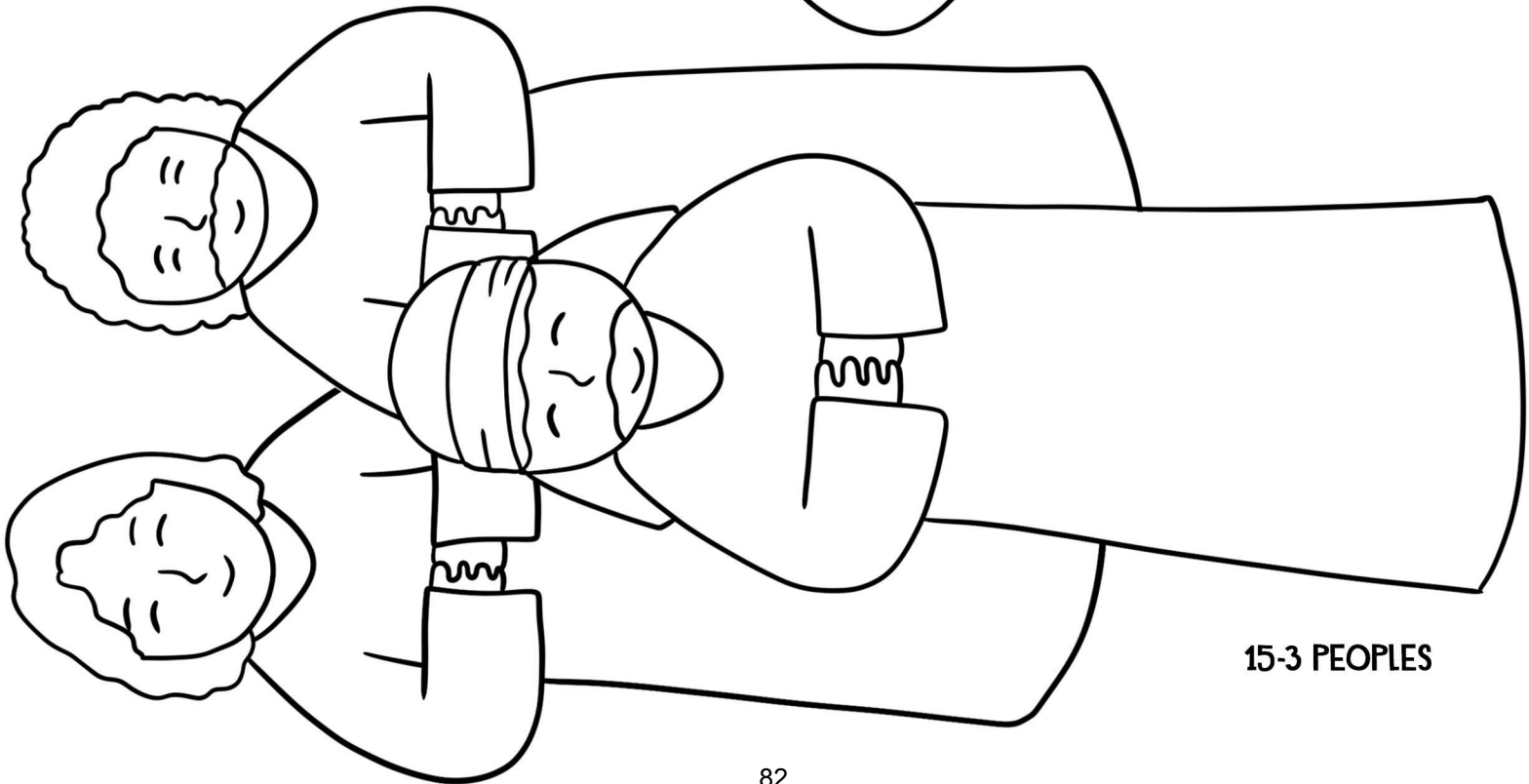

15-3 PEOPLES

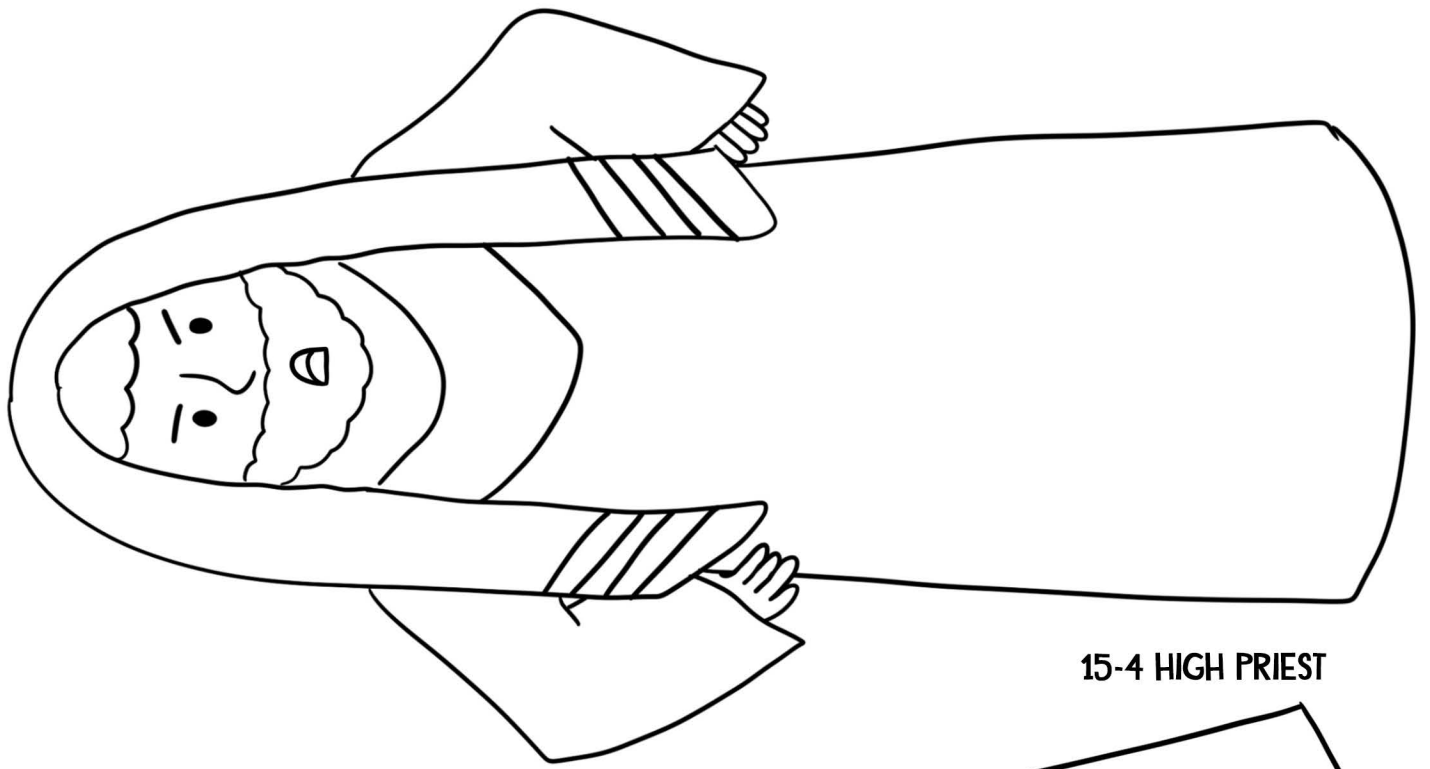

15-4 HIGH PRIEST

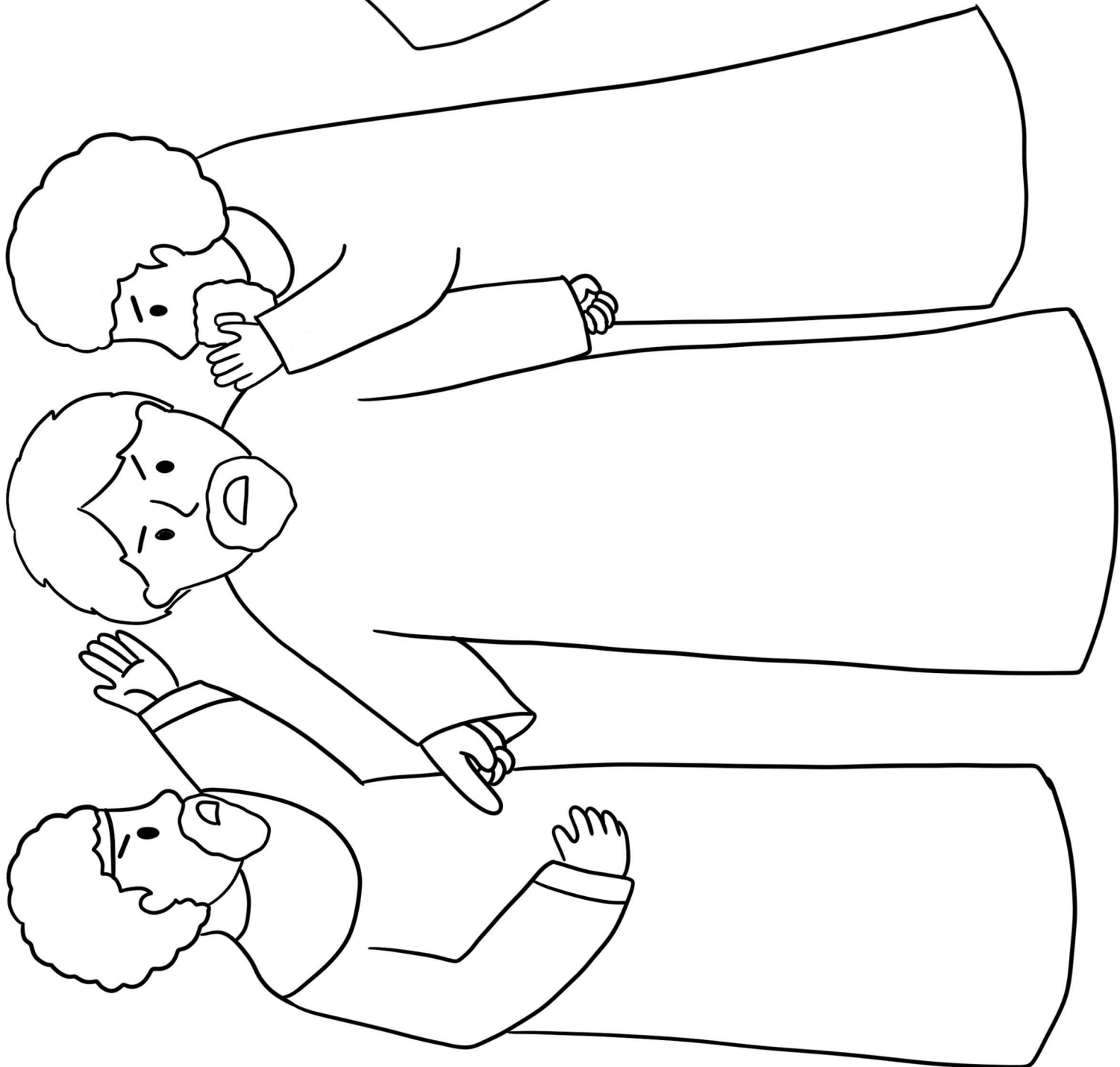

15-5 PEOPLE HATING

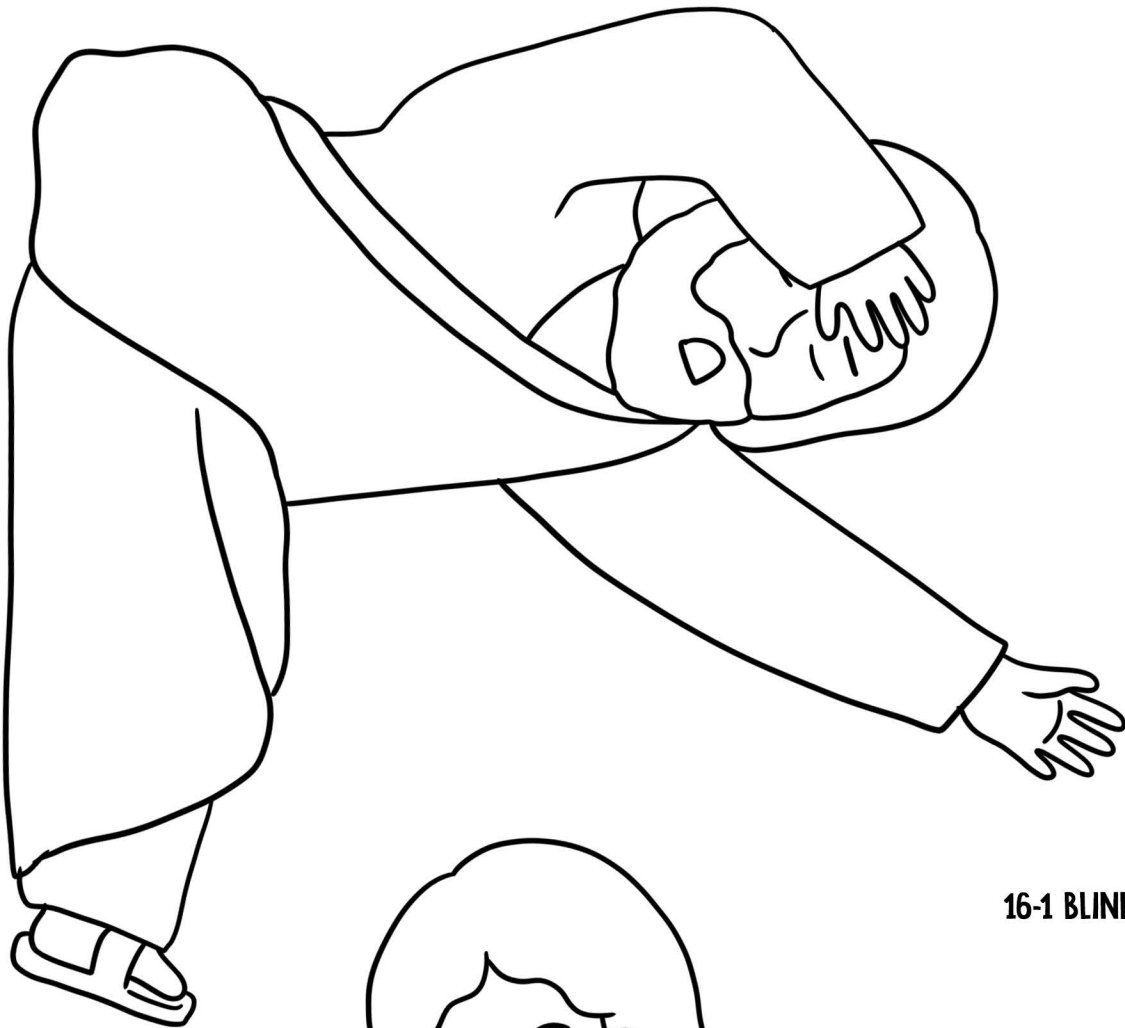

16-1 BLINED SAUL



16-2 JESUS



16-3 HEALED SAUL

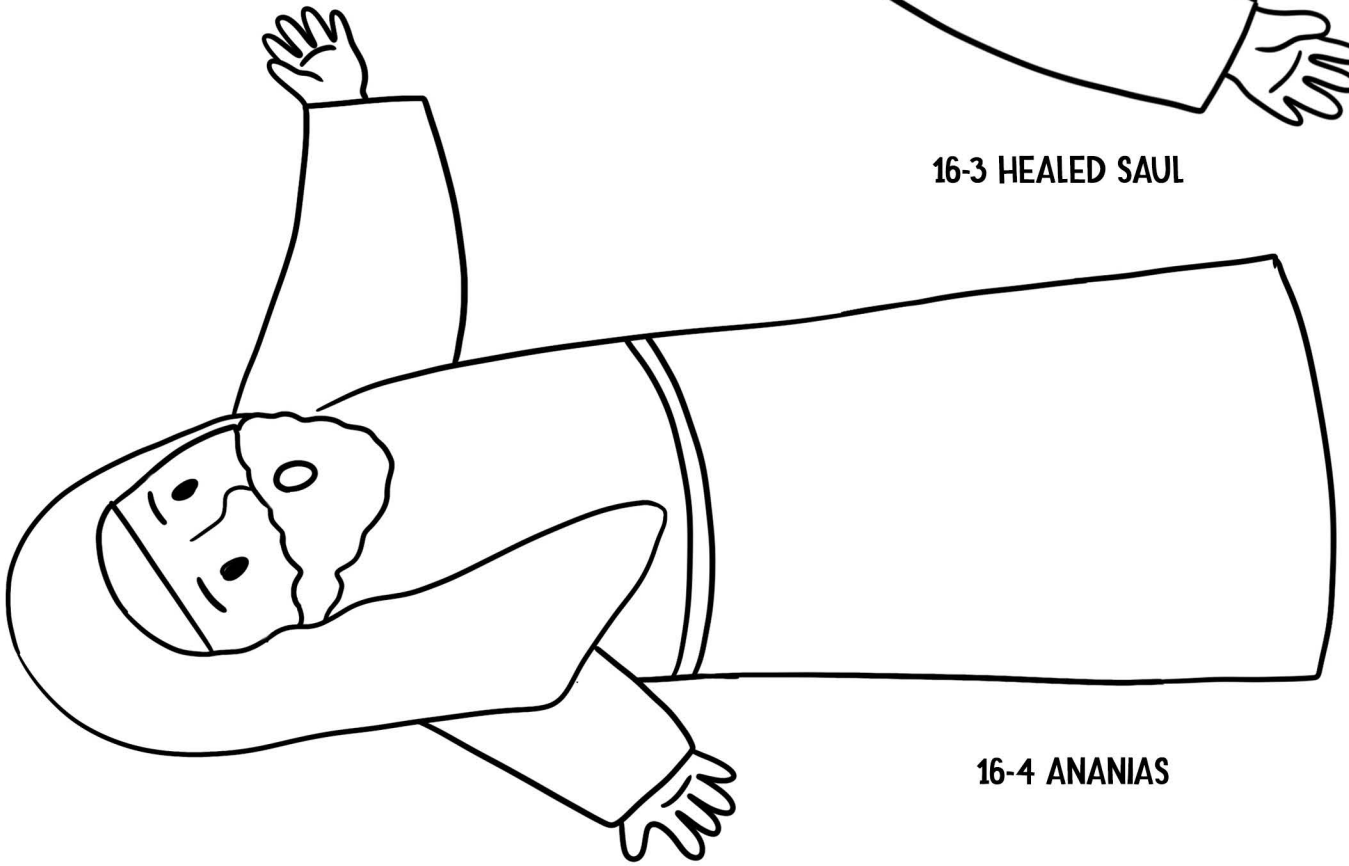

16-4 ANANIAS

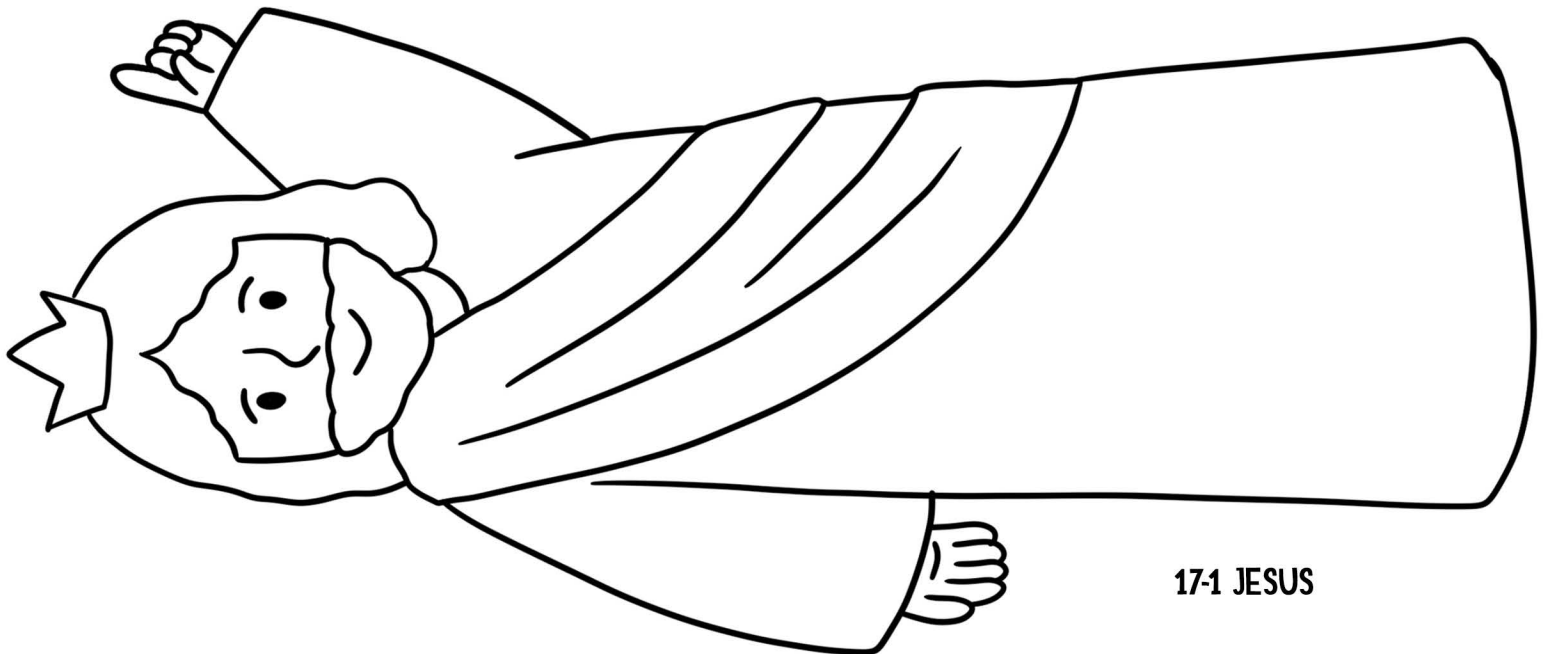

17-1 JESUS

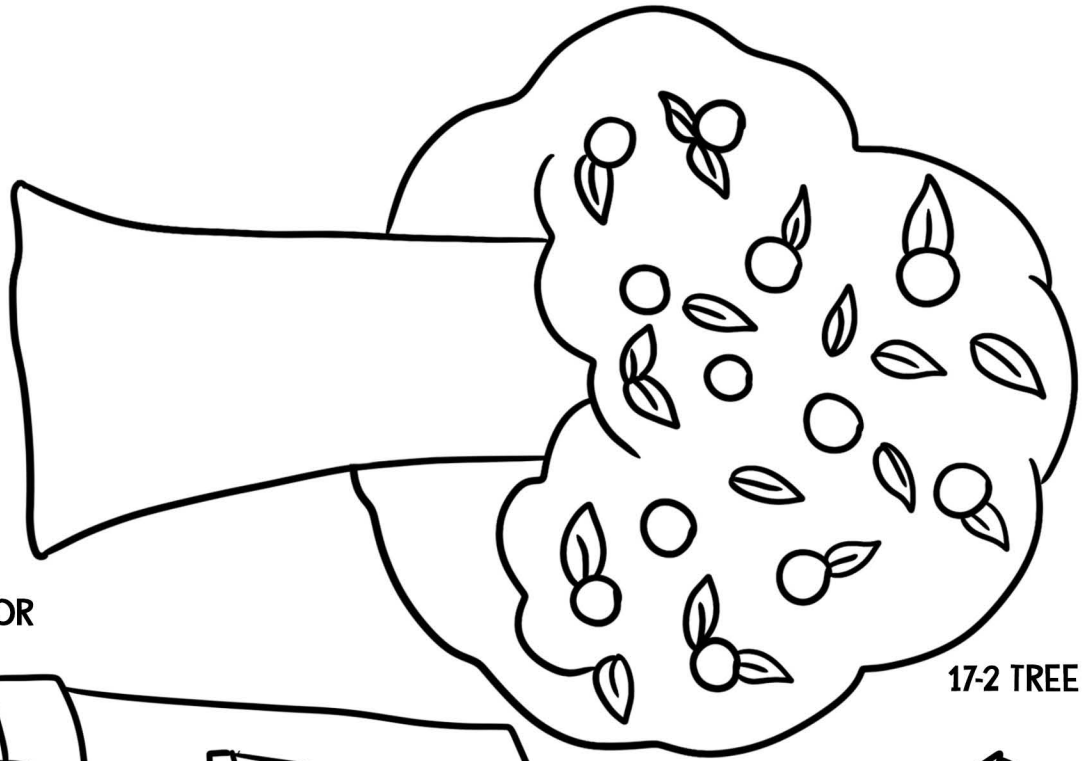

17-2 TREE

17-3 HEAVEN'S DOOR

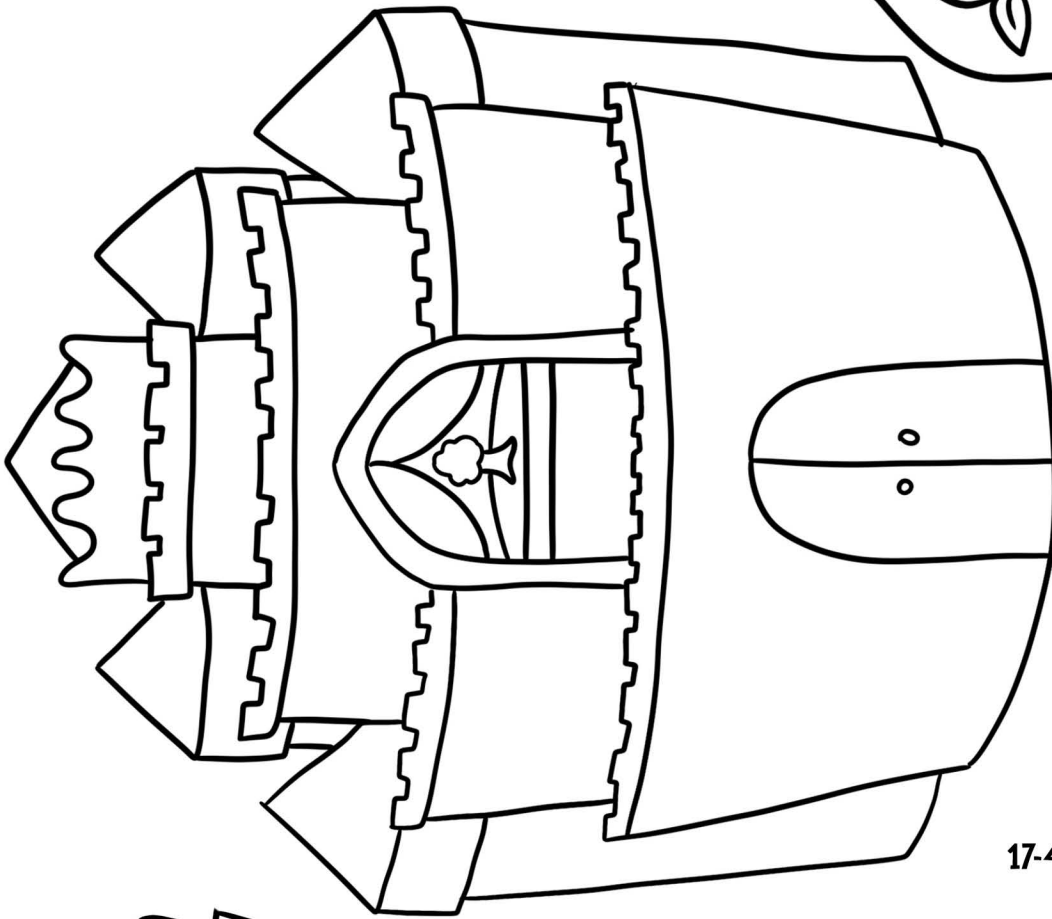

17-4 BOOK

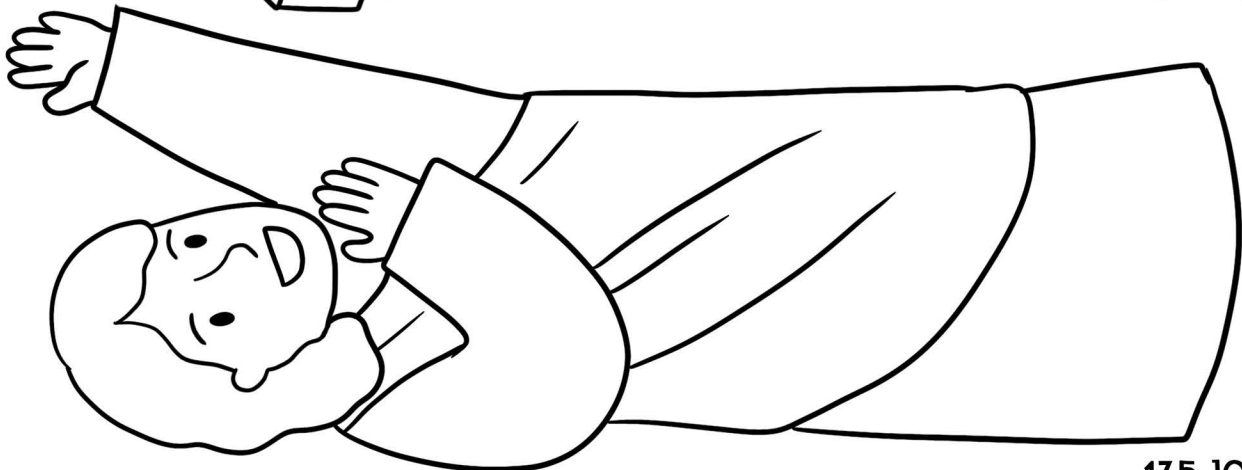
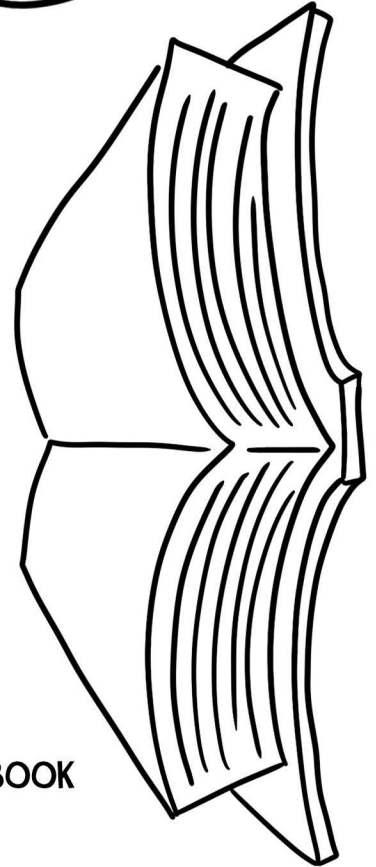

17-5 JOHN